

Switches



	General	188
	Aprovals	189
	Informations	190
	Cam Switches	192
	Basic designs	194
	Cam Switches	197
	On-Off switches, Changeover switches	197
	Star-Delta switches	201
	Multi speed switches	204
	Control switches	209
	Voltmeter selector switches	212
	Ammeter switches	213
	Gang switches	215
	Multi step switches	218
	Mini-Cam Switches	230
	Technical data	230
	On-Off switches, Changeover switches	231
	Star-Delta switches	231
	Control switches	231
	Voltmeter selector switches, Ammeter switches	232
	Gang switches, Multi step switches	232
	Load switches	234
	On-Off switches	234
	Changeover switches	235
	Handles and plates	236
	Operating knobs and handles	236
	Escutcheon plates	237
	Angles of rotation	241
	Optional Extras	243
	Drive units	243
	Door couplings	244
	Key operated switches	245
	Padlock devices	246
	Switch interlocks	247
	Couplings	248
	Accessories	250
	Special switches	251
	Technical data	253
	Cam switches	253
	Load switches	255
	Dimensions	256
	Cam switches	256
	Load switches	260
	Accessories	261

General

Test Authorities, Registration Mark, Approvals

Low voltage switchgear from Benedict GmbH is built and tested to national and international specifications. All devices suit all important specifications without any test obligation, like VDE, BS and also relative to IEC Recommendations and to European Standards like IEC 947 and EN 60947.

It is for this reason of our Low voltage switchgear is used all over the world. In order to provide special versions, limitations to the max. voltages, currents and power ratings or special markings are sometimes necessary.

Quality Control System

Since November 1991 Benedict GmbH has been certified according to the quality control system **ÖNORM EN ISO 29001**. The target of the ISO-certification is, to grant the customer the quality of the performance of his supplier, who is audited in accordance with this standard.

CE-Marking



The manufacturer has to sign his products with the CE-Marking. With the CE-Marking the manufacturer confirms the accordance with the different EEC Directives. The CE-Marking is absolutely necessary to sell the products in the EEC.

Below you find the EEC Directives concerning our products.

Low Voltage Directive 2006/95/EC

EMC Directive 2004/108/EC

RoHS + WEEE 2002/95/EC + "002/96/EC

Country	North America	Russia
State deputy or private examination (state admitted)	UL Canada, USA	EAC
Label marking of examination boards	Listed Component	
Duty of approvals	all switchgear	all switchgear

Explanations for choice and supply of low voltage switchgear in Canada and USA

Marking of auxiliary contacts

At several devices in UL-data are two voltages for auxiliary contacts mentioned (e. g.: 600 volts at same potential, 150 volts at different potentials). That means, if the voltage is higher than 150 volts, the control voltage applied to input terminals must be at the same potential.

Low voltage switchgear for auxiliary circuits (e. g. contactor relays, control units, auxiliary contacts in general) usually approved for "Heavy Duty" or "Standard Duty" UL and besides these marked with the admissible max. voltage or with short codes (see table).

Marking of auxiliary contacts according to CSA and UL	Max. rated values per pole			Cont. Current A	Contact Rating Code Designation
	Voltage V	Current Make A	Break A		
Heavy Duty (HD or HVY DTY)	AC 120	60	6	10	A150
	AC 240	30	3	10	A300
	AC 480	15	1,5	10	A600
	AC 600	12	1,2	10	A600
	DC 125	2,2	2,2	10	N150
	DC 250	1,1	1,1	10	N300
	DC 600	0,4	0,4	10	N600
Standard Duty (SD or STD DTY)	AC 120	30	3	5	B150
	AC 240	15	1,5	5	B300
	AC 480	7,5	0,75	5	B600
	AC 600	6	0,6	5	B600
	DC 125	1,1	1,1	5	P150
	DC 250	0,55	0,55	5	P300
	DC 600	0,2	0,2	5	P600
-	AC 120	15	1,5	2,5	C150
	AC 240	7,5	0,75	2,5	C300
	AC 480	3,75	0,375	2,5	C600
	AC 600	3	0,3	2,5	C600
	DC 125	0,55	0,55	2,5	Q150
	DC 250	0,27	0,27	2,5	Q300
	DC 600	0,1	0,1	2,5	Q600
-	AC 120	3,6	0,6	1	D150
	AC 240	1,8	0,3	1	D300
	DC 125	0,22	0,22	1	R150
	DC 250	0,11	0,11	1	R300
-	AC 120	1,8	0,3	0,5	E150

Discernment at UL-Standards

Recognized Component Industrial Control Equipment

UL issues yellow "Guide cards" with Guide- and File-No.

Devices have permission to be marked with on the label

Devices as components approved for "factory wiring": devices for employment in control panels, when they are selected, mounted and wired according to the charging conditions by skilled worker.

Valid UL-Standards: UL 508 "Standard for Industrial Control Equipment" (partly limited)

Are devices approved as "Listed Equipment" the approval is also valid for using as "Recognized Component"

Listed Industrial Control Equipment

UL issues white "Guide cards" with Guide- and File-No.

Devices have to be marked with the "UL-Listing Mark"

Devices approved for "field wiring",

- a) devices for employment in control panels, when they are mounted and wired by skilled worker.
- b) devices for retail in USA

Valid UL-Standards: UL 508 "Standard for Industrial Control Equipment" (unlimited)

Approvals

Country	USA, Canada UL	Europe	Russia EAC	CB/CCA- Certificates
Type				

Cam Switches (UL-Listed as MANUAL MOTOR CONTROLLER and suitable as MOTOR DISCONNECT)

M10	o	o	o	o
M10H	o	o	o	o
M20	o	o	o	o
N20	o	o	o	o
N33F	o	o	o	o
N40	-	o	o	o
N60	-	o	o	o
N80	o	o	o	o
N100	o	o	o	o
N200	o	o	o	o
L400	o	o	-	-

o In standard version approved / No testing required CE x In test
 - Not provided for test till now

Technical Information

Degree of protection acc. to IEC 60947-1

Protection ratings are prefixed by the internationally agreed letters IP followed by two digits.

1st digit: Pertains to solid objects
2nd digit: Pertains to water.

1 st digit	Short description	Definition
1	Protected against solid objects greater than 50 mm	Excludes solid objects exceeding 50 mm in diameter and protects against contact with live and moving parts by a large body surface such as a hand (but not against deliberate access).
2L	Protected against solid objects greater than 12,5 mm and against contact by standard test finger	Excludes solid objects exceeding 12,5 mm in diameter and protects against contact with live and moving parts by a standard test finger or similar objects not exceeding 80 mm in length.
3	Protected against solid objects greater than 2,5mm	Excludes solid objects exceeding 2,5 mm in diameter or thickness.
4	Protected against solid objects greater than 1 mm	Excludes solid objects exceeding 1 mm in diameter or thickness.
5	Dust protected	Prevents ingress of dust in quantities and locations that would interfere with the intended operation of the equipment.
6	Dust tight	Prevents ingress of dust.

2 nd digit	Short description	Definition
1	Protected against dripping water	Dripping water (vertically falling drops) shall have no harmful effect.
2	Protected against dripping water when tilted up to 15°	Vertically dripping water shall have no harmful effect when the enclosure is tilted at any angle up to 15° from its normal position.
3	Protected against spraying water	Water falling as a spray at an angle up to 60° from the vertical shall have no harmful effect.
4	Protected against splashing water	Water splashed against the enclosure from any direction shall have no harmful effect.
5	Protected against water jets	Water protected by a nozzle against the enclosure from any direction shall have no harmful effect.
6	Protected against heavy seas	Water from heavy seas or water projected in powerful jets shall not enter the enclosure in harmful quantities.
7	Protected against the effects of immersion	Ingress of water in a harmful quantity shall not be possible when the enclosure is immersed in water under standard conditions of pressure and time.
8	Protected against submersion	No ingress of water.

Resistance to climatic conditions acc. to IEC60068

Open-type devices are climate-resistant in the constant climate according to IEC60068-2-3 (this is a climate with an ambient temperature of 40°C and an atmospheric humidity of 90 to 95%).

Enclosed devices are climate-resistant in an alternating climate according to IEC 68-2-30 (this is a moist alternating climate with a 24-hour cycle between climates with an ambient temperature of 25°C, and an atmospheric humidity of 95 to 100% and an ambient temperature of 40°C, and an atmospheric humidity of 90 to 96% in the presence of condensation during rises in temperature).

Data are valid up to an altitude of 2000m above sea level.

Short circuit protection

Back up fuses should be used to protect contactors and starters against short circuits. For starters the device with the smaller admissible fuse at the main and at the control circuit (contactor or thermal overload) determines the fuse size.

After a short circuit devices have to be checked for correct operation. Disconnect power before proceeding with any work on the equipment!











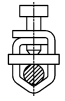

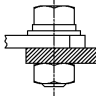



Mounting positions

Zulässige Umgebungstemperatur

Operation	open °C	-40 up to +60
	enclosed °C	-40 up to +40
Storage	°C	-50 up to +90

Technical Information

Terminal screws

Devices Type	Kind of connection				Screw driver	Tightening torque	
	Screw with washer	Screw with clamp box	2 Screw s	Screw with w. nut		Nm	lb. inch
							
Cam Switches							
M4H..	M2,5	-	-	-	 Pz1	0,6	5
M10	M3	-	-	-	 Pz2	0,6 - 1,2	5 - 11
M10H	M3,5	-	-	-	 Pz2	0,8 - 1,4	7 - 12
M20, N20, N33F	M4	-	-	-	 Pz2	1,2 - 1,8	11 - 16
N40	M5	-	-	-	 Pz2	2,5 - 3	22 - 26
N60, N80	-	-	2 x M5	-	 Pz2	2,5 - 3	22 - 26
N100	-	-	2 x M6	-	 Pz3	3,5 - 4,5	31 - 40
N200	-	-	-	M10		10	88
L100	-	-	2 x M5	-	 Pz2	2,5 - 3	22 - 26
L160	-	-	-	M8		4 - 6,5	35 - 57
L400	-	-	-	M12		16	140
L600	-	-	-	M16		24	210
L800	-	-	-	M16		24	210
L1200	-	-	-	M16		24	210

Telux - Cam Switches

Ratings								Designs			
Typ	Rated current Therm.			Motor			Plate mm	Panel moun.	Single hole mount.	Flush mount.	
	I_{in} open	AC21	atU _e	AC3	AC23			M10H, M20 IP65 IP40	with Plate IP65	without Plate IP65	
	A	A	V	3~400V kW	3~400V A	3~400V kW					
M4H	10	10	440	2,2	6	3	30□	M4H E	M4H Z	M4H ZO	-
M10H	20	20	690	5,5	16	7,5	48□	M10H E	M10H Z	M10H ZO	-
M10	20	20	440	5,5	16	7,5	48□	-	-	-	M10 UP
M20	32	32	690	11	30	15	48□	M20 E	M20 Z	M20 ZO	-
N20	32	32	690	11	30	15	64□	N20 E	-	-	-
N33F	50	50	690	15	45	22	64□	N33F E	N33F Z	-	-
N40	63	63	690	15	45	22	88□	N40 E	-	-	-
N60	85	85	690	25	60	30	88□	N60 E	-	-	-
N80	115	115	690	30	85	45	88□	N80 E	-	-	-
L100	125	125	690	15	45	22	88□	L100 E	-	-	-
L160	180	180	690	25	60	30	88□	L160 E	-	-	-
N100	150	150	690	40	110	55	132□	N100 E	-	-	-
N200	250	250	690	70	140	70	132□	N200 E	-	-	-
L400	400	400	690	70	140	70	132□	L400 E	-	-	-
L600	600	400	690	70	140	70	132□	L600 E	-	-	-
L800	800	400	690	70	140	70	132□	L800 E	-	-	-
L1200	1200	400	690	70	140	70	132□	L1200 E	-	-	-

Cam Switches 10 - 250A

Cam switches can be used for virtually all purposes, e.g. as motor, main, control or instrument switches. Over and above the switching programs mentioned in the list, an effectively limitless number of special programs can be implemented.

Load switch L.. 125 - 1200A

Load switches are primarily employed where resistive or slightly inductive current loads are to be switched on and off, or switching takes place without loading. Load switches are assembled by parallel switching of two or more of cam switch contacts. With customer built main terminal protection, load switch L... can also be used as main switch.

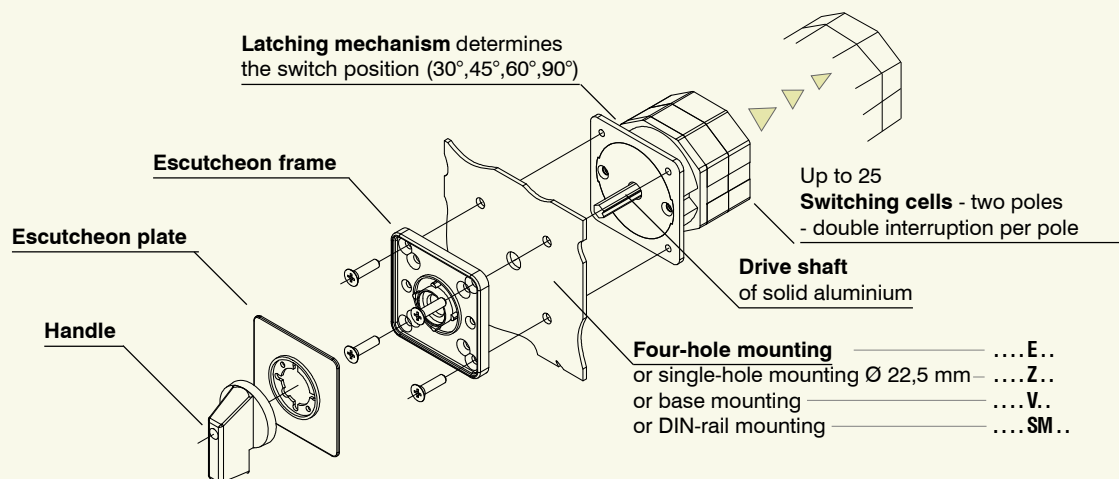

Designs Base mounting IP40	DIN-rail mounting IP40	Modular IP40	Plastic enclosed ..P.. IP40 ..PF.. IP65	horizontal, IP65	Motor switch enclosed IP65	Terminal box mounting IP65	Cast enclosed ..G.. IP40 ..GF.. IP65
-	-	-	-	-	-	-	-
M10H V ♦♦	M10H SM ♦♦	M10H SMA ♦♦	-	-	M10H PM ♦♦	-	-
-	-	-	M10 P(F) ♦♦	-	-	M10 KE ♦♦	-
M20 V ♦♦	M20 SM ♦♦	M20 SMA ♦♦	-	-	-	-	-
N20 V ♦♦	N20 SM ♦♦	-	N20 P(F) ♦♦	-	N20 PM ♦♦	N20 KE ♦♦	N20 G(F) ♦♦
N33F V ♦♦	N33F SM ♦♦	-	N33F P(F) ♦♦	-	N33F PM ♦♦	N33F KE ♦♦	-
N40 V ♦♦	-	-	N40 P(F) ♦♦	N40 PLF ♦♦	-	-	-
N60 V ♦♦	-	-	N60 P(F) ♦♦	N60 PLF ♦♦	-	-	-
N80 V ♦♦	-	-	N80 P(F) ♦♦	N80 PLF ♦♦	-	-	-
L100 V ♦♦	-	-	-	-	-	-	-
L160 V ♦♦	-	-	-	-	-	-	-
N100 V ♦♦	-	-	N100 PF ♦♦	-	-	-	-
N200 V ♦♦	-	-	N200 PF ♦♦	-	-	-	-
L400 V ♦♦	-	-	-	-	-	-	-
L600 V ♦♦	-	-	-	-	-	-	-
L800 V ♦♦	-	-	-	-	-	-	-
L1200 V ♦♦	-	-	-	-	-	-	-

Ordering

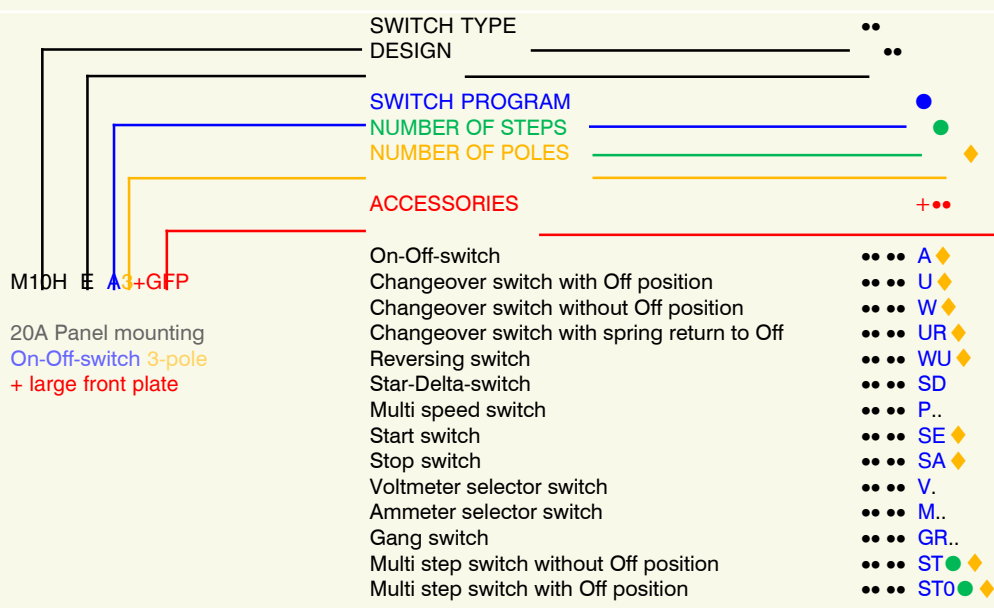

Panel mounting designs

Switches of the panel mounting designs listed below have protection from front IP40. Where a shaft seal (appendix +WD) is used, the protection is increased to IP54. Use of a moisture proofing cap (appendix +FR) results in an increase in rear protection to IP54. In the standard version, the switches are delivered with a square escutcheon plate and black twist knob. Forward mounting is possible for some of the

design E switches. The position of the terminals of the standard switches is left and right, at switch M10H the terminals are above and below. Where a knob insert is turned by 90° (can easily be performed after delivery), the position of the terminals can be changed.

Dimensions see page 256.



Design	Description	Type appendix	Possible switch sizes					L...
			M10H	M20	N20 N33F	N40 N60 N80	N100 N200	
Panel mounting For installation in control panels, machines and equipment. For panel thickness of over 5mm, an extended switch shaft is required (appendix +VW). Protection from front: M10H, M20 IP65 all others IP40	E	X	X	X	X	X	X	
Central fixing 22,5mm Switch for mounting with standard 22,5mm mounting holes and 1-4mm panel thickness. Protection from front: IP65 Wrench J7049 necessary	Z	X	X	X ²⁾	-	-	-	
Central fixing 22,5mm Switch without escutcheon plate , for installation with standard 22,5mm mounting holes and 1-4mm panel thickness. Protection from front: IP65 Wrench J7049 necessary	ZO	X	X	-	-	-	-	
Flush mounting version Switch with white instrument knob, cream escutcheon plate with black markings, for installation in 65mm flush mounting boxes and use of Unitas plate. Supplied with flush mounting box: appendix +UP. Maximum number of cells with: M10 FM box 45mm deep 2 FM box 65mm deep 4	UP	X ¹⁾	-	-	-	-	-	

1) Switches are delivered with switch type M10





2) For switch types N33F only, max. 3 poles and 3 cells

Base mounting designs

Switches of the designs listed below have protection from front IP40. When a shaft seal (appendix +WD) is used, the front protection type is increased to IP54. In the standard version, the switches are delivered with a square escutcheon plate and black twist knob (design SMA with grey cover and grey toggle knob). Door couplings are advisable for switchgear cabinets with hinged doors.

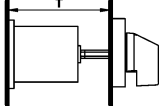
The position of the terminals of the standard switches is left and right, at switch M10H the terminals are above and below. Where a knob insert is turned by 90° (can easily be performed after delivery), the position of the terminals can be changed.

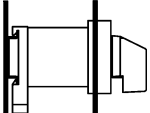
Dimensions see page 257.

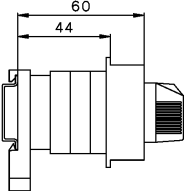
Design	Possible switch sizes	Possible switch sizes					
		Type appendix	M10H	M20	N20 N33F	N40 N60 N80	N100 N200
 <p>Base mounting For screw mounting to the back wall or floor of distributor boxes, or of appliances with removable lids. Additional it is necessary to state the installation depth - that is the distance between mounting level of the switch and the inside edge of the door (dimension T).</p>  <p>Door couplings see page 244</p>	V ... +T/...	X	X	X	X	X	X
 <p>Snap-on mounting on DIN-rail Switch with square escutcheon plate, for snap-on mounting on standard DIN EN 50022 rail. Additional it is necessary to state the installation depth - that is the distance between mounting level of the switch and the inside edge of the door (dimension T).</p>  <p>Door couplings see page 244</p>	SM ... +T/...	X	X	X	-	-	-
 <p>Snap-on mounting on DIN-rail with installation cover for standard opening and toggle knob. The lay-out of the terminals of the standard switches is above and below. Dimensions for Switch types M10H SMA .. with 1-3 cells M20 SMA .. with 1 or 2 cells</p>  <p>further dimensions see page 257</p>	SMA	X	X	-	-	-	-

Plastic enclosed switches

The switches, which have durable plastic enclosures, are intended for wall mounting or attachment to machines. In the standard version, they are supplied with a light-grey enclosure, square escutcheon plate, black markings on a silver background, and a black twist knob. Other colours and colour combinations are available for most enclosure types. It is not possible to mount an additional rectangular plate. The enclosure base is equipped with 4 entry glands with heavy-gauge conduit threads (see drawings). In all types of plastic enclosures, two terminals that are connected and insulated from switch column can be provided for a PE conductor (appendix +PE). In addition, 1 or 2 pilot lamps (appendix +SL..) with neon lights can be installed.

Dimensions see page 258.

Cast aluminium enclosed switches

The switches with cast aluminium enclosures are intended for wall mounting or attachment to machines, under heavy-duty operating conditions. The switches are delivered with a square escutcheon plate, black markings on a silver background, and a black instrument knob. It is not possible to mount an additional rectangular plate. The enclosure base makes provision for 2 (4) entry glands with heavy-gauge conduit threads. If a switch with an aluminium enclosure is to be mounted directly on the terminal box of a motor, a 35mm or 50mm hole can be made in the floor of the switch enclosure. Design PLF is the replacement for designs G and GF at types N40 to N80.

Dimensions see page 259.



Design

Description	Type appendix	Possible switch sizes							
		M10H	N20	N33F	N40	N60	N80	N100	N200
Plastic enclosure light grey Protection class IP40 Maximum number of cells	P	X	X	X	X	X	-	-	-
Plastic enclosure light grey Moisture protection Protection class IP65 Maximum number of cells	PF	6	6	6	6	5	5	4	3
Plastic enclosure horizontal light grey Moisture protection Protection class IP65 Maximum number of cells	PLF	-	-	-	X	X	X	-	-
Cast enclosure Protection class IP40 Maximum number of cells	G	-	X	-	-	-	-	-	-
Cast enclosure Moisture protection Protection class IP65 Maximum number of cells	GF	-	X	-	-	-	-	-	-
Terminal box mounting Protection class IP65 These switches are front mounted on a terminal box. The switch cells protrude through a hole into the terminal compartment. Maximum number of cells	KE	X	X	X	-	-	-	-	-
Plastic motor switch enclosure Moisture protection Protection class IP65 Maximum number of cells	PM	-	X	-	-	-	-	-	-

Switching programs

Description	Wiring diagram	Switching angle	Number of cells ↓ Size ↓ AC21	Type	Design see page 6-8 E. Z. V. SMA. P. G.	Switch pro- gram	Escutcheon plate
On-Off-switches A							
1-pole		60°	1	48 □ 20A	M10H . x x x x x ¹⁾ - . A1		
				32A	M20 . x x x x - - . A1		
				64 □ 32A	N20 . x - x - x x . A1		
				50A	N33F . x x x - x - . A1		
				88 □ 63A	N40 . x - x - x - . A1		
80A	N60 . x - x - x - . A1						
115A	N80 . x - x - - - . A1						
132 □ 150A	N100 . x - x - - - . A1						
250A	N200 . x - x - - - . A1						
2-pole		60°	1	48 □ 20A	M10H . x x x x x ¹⁾ - . A2		
				32A	M20 . x x x x - - . A2		
				64 □ 32A	N20 . x - x - x x . A2		
				50A	N33F . x x x - x - . A2		
				88 □ 63A	N40 . x - x - x - . A2		
80A	N60 . x - x - x - . A2						
115A	N80 . x - x - - - . A2						
132 □ 150A	N100 . x - x - - - . A2						
250A	N200 . x - x - - - . A2						
3-pole		60°	2	48 □ 20A	M10H . x x x x x ¹⁾ - . A3		
				32A	M20 . x x x x - - . A3		
				64 □ 32A	N20 . x - x - x x . A3		
				50A	N33F . x x x - x - . A3		
				88 □ 63A	N40 . x - x - x - . A3		
80A	N60 . x - x - x - . A3						
115A	N80 . x - x - - - . A3						
132 □ 150A	N100 . x - x - - - . A3						
250A	N200 . x - x - - - . A3						
4-pole 4. pole early make		60°	2	48 □ 20A	M10H . x x x x x ¹⁾ - . A4		
				32A	M20 . x x x x - - . A4		
				64 □ 32A	N20 . x - x - x x . A4		
				50A	N33F . x - x - x - . A4		
				88 □ 63A	N40 . x - x - x - . A4		
80A	N60 . x - x - x - . A4						
115A	N80 . x - x - - - . A4						
132 □ 150A	N100 . x - x - - - . A4						
250A	N200 . x - x - - - . A4						
6-pole		60°	3	48 □ 20A	M10H . x x x x x ¹⁾ - . A6		
				32A	M20 . x x x x - - . A6		
				64 □ 32A	N20 . x - x - x x . A6		
				50A	N33F . x - x - x - . A6		
				88 □ 63A	N40 . x - x - x - . A6		
80A	N60 . x - x - x - . A6						
115A	N80 . x - x - - - . A6						
132 □ 150A	N100 . x - x - - - . A6						
250A	N200 . x - x - - - . A6						

Ordering example: AC21 250A panel mounting, On-Off-switch 6-pole, Escutcheon plate OFF - ON

N200 E A6+003

1) Plastic enclosed switches are delivered with switch type M10.

Switching programs

Description	Wiring diagram	Switching angle	Number of cells ↓ Size ↓ AC21	Type	Design see page 6-8 E. Z. V. SMA. P. G.	Switch pro- gram	Escutcheon plate
Changeover switches U							
1-pole		60°	1 48 □ 20A 32A	M10H . M20 .	x x x x x ¹⁾ x x x x - -	. U1 . U1	
			64 □ 32A 50A	N20 . N33F .	x - x - x x x x x - x -	. U1 . U1	
			88 □ 63A 80A 115A	N40 . N60 . N80 .	x - x - x - x - x - x - x - x - - -	. U1 . U1 . U1	+007
			132 □ 150A 250A	N100 . N200 .	x - x - - - x - x - - -	. U1 . U1	
2-pole		60°	2 48 □ 20A 32A	M10H . M20 .	x x x x x ¹⁾ - x x x x - -	. U2 . U2	
			64 □ 32A 50A	N20 . N33F .	x - x - x x x x x - x -	. U2 . U2	
			88 □ 63A 80A 115A	N40 . N60 . N80 .	x - x - x - x - x - x - x - x - - -	. U2 . U2 . U2	+007
			132 □ 150A 250A	N100 . N200 .	x - x - - - x - x - - -	. U2 . U2	
3-pole		60°	3 48 □ 20A 32A	M10H . M20 .	x x x x x ¹⁾ - x x x x - -	. U3 . U3	
			64 □ 32A 50A	N20 . N33F .	x - x - x x x x x - x -	. U3 . U3	
			88 □ 63A 80A 115A	N40 . N60 . N80 .	x - x - x - x - x - x - x - x - - -	. U3 . U3 . U3	+007
			132 □ 150A 250A	N100 . N200 .	x - x - - - x - x - - -	. U3 . U3	
4-pole 4. pole early make		60°	4 48 □ 20A 32A	M10H . M20 .	x x x x x ¹⁾ - x x x x - -	. U4 . U4	
			64 □ 32A 50A	N20 . N33F .	x - x - x x x - x - x -	. U4 . U4	
			88 □ 63A 80A 115A	N40 . N60 . N80 .	x - x - x - x - x - x - x - x - - -	. U4 . U4 . U4	+007
			132 □ 150A 250A	N100 . N200 .	x - x - - - x - x - - -	. U4 . U4	
6-pole		60°	6 48 □ 20A 32A	M10H . M20 .	x x x - x ¹⁾ - x x x - - -	. U6 . U6	
			64 □ 32A 50A	N20 . N33F .	x - x - x x x - x - x -	. U6 . U6	
			88 □ 63A 80A 115A	N40 . N60 . N80 .	x - x - x - x - x - x - x - x - - -	. U6 . U6 . U6	+007
			132 □ 150A 250A	N100 . N200 .	x - x - - - x - x - - -	. U6 . U6	

Ordering example: AC21 250A panel mounting, changeover switch 6-pole, Escutcheon plate 1 - OFF - 2 **N200 E U6+007**

1) Plastic enclosed switches are delivered with switch type M10.

Switching programs

Description	Wiring diagram	Switching angle	Number of cells ↓ Size ↓ AC21	Type	Design see page 6-8 E. Z. V. SMA. P. G.	Switch pro- gram	Escutcheon plate
Changeover switches without off W							
1-pole		60°	1	48 □ 20A 32A	M10H . x x x x x ¹⁾ - M20 . x x x x - -	. W1 . W1	
				64 □ 32A 50A	N20 . x - x - x x N33F . x x x - x -	. W1 . W1	
				88 □ 63A 80A 115A	N40 . x - x - x - N60 . x - x - x - N80 . x - x - - -	. W1 . W1 . W1	
				132 □ 150A 250A	N100 . x - x - - - N200 . x - x - - -	. W1 . W1	
2-pole		60°	2	48 □ 20A 32A	M10H . x x x x x ¹⁾ - M20 . x x x x - -	. W2 . W2	
				64 □ 32A 50A	N20 . x - x - x x N33F . x x x - x -	. W2 . W2	
				88 □ 63A 80A 115A	N40 . x - x - x - N60 . x - x - x - N80 . x - x - - -	. W2 . W2 . W2	
				132 □ 150A 250A	N100 . x - x - - - N200 . x - x - - -	. W2 . W2	
3-pole		60°	3	48 □ 20A 32A	M10H . x x x x x ¹⁾ - M20 . x x x x - -	. W3 . W3	
				64 □ 32A 50A	N20 . x - x - x x N33F . x x x - x -	. W3 . W3	
				88 □ 63A 80A 115A	N40 . x - x - x - N60 . x - x - x - N80 . x - x - - -	. W3 . W3 . W3	
				132 □ 150A 250A	N100 . x - x - - - N200 . x - x - - -	. W3 . W3	
4-pole 4. pole early make		60°	4	48 □ 20A 32A	M10H . x x x x x ¹⁾ - M20 . x x x x - -	. W4 . W4	
				64 □ 32A 50A	N20 . x - x - x x N33F . x - x - x -	. W4 . W4	
				88 □ 63A 80A 115A	N40 . x - x - x - N60 . x - x - x - N80 . x - x - - -	. W4 . W4 . W4	
				132 □ 150A 250A	N100 . x - x - - - N200 . x - x - - -	. W4 . W4	
6-pole		60°	6	48 □ 20A 32A	M10H . x x x - x ¹⁾ - M20 . x x x - - -	. W6 . W6	
				64 □ 32A 50A	N20 . x - x - x x N33F . x - x - x -	. W6 . W6	
				88 □ 63A 80A 115A	N40 . x - x - x - N60 . x - x - x - N80 . x - x - - -	. W6 . W6 . W6	
				132 □ 150A 250A	N100 . x - x - - - N200 . x - x - - -	. W6 . W6	

Ordering example: AC21 250A panel mounting, changeover switch without off 6-pole, N200 E W6

1) Plastic enclosed switches are delivered with switch type M10.





Switching programs

Description	Wiring diagram	Switching angle	Number of cells ↓ Size ↓ AC21	Type	Design see page 6-8 E. Z. V. SMA. P. G.	Switch pro- gram	Escutcheon plate
Reversing switches WU							
2-pole		60°	2	48 □ 20A	M10H . x x x x x ¹⁾ - . WU2	. WU2	
				32A	M20 . x x x x - - . WU2		
				64 □ 32A	N20 . x - x - x x . WU2		
				50A	N33F . x x x - x - . WU2		
				88 □ 63A	N40 . x - x - x - . WU2		
80A	N60 . x - x - x - . WU2						
115A	N80 . x - x - - - . WU2						
132 □ 150A	N100 . x - x - - - . WU2						
250A	N200 . x - x - - - . WU2						
2-pole without off cross switch		60°	2	48 □ 20A	M10H . x x x x x ¹⁾ - . WK2	. WK2	
				32A	M20 . x x x x - - . WK2		
				64 □ 32A	N20 . x - x - x x . WK2		
				50A	N33F . x x x - x - . WK2		
				88 □ 63A	N40 . x x - x - . WK2		
80A	N60 . x - x - x - . WK2						
115A	N80 . x - x - - - . WK2						
132 □ 150A	N100 . x - x - - - . WK2						
250A	N200 . x - x - - - . WK2						
2-pole with spring return from both sides to off		30°	2	48 □ 20A	M10H . x x x x x ¹⁾ - . WU2R2	. WU2R2	
				32A	M20 . x x x x - - . WU2R2		
				64 □ 32A	N20 . x - x - x x . WU2R2		
50A	N33F . x x x - x - . WU2R2						
88 □ 63A	N40 . x - x - x - . WU2R2						
2-pole position 1 latched position 2 with spring return to off		60°+30°	2	48 □ 20A	M10H . x x x x x ¹⁾ - . WU2R1	. WU2R1	
				32A	M20 . x x x x - - . WU2R1		
				64 □ 32A	N20 . x - x - x x . WU2R1		
50A	N33F . x x x - x - . WU2R1						
88 □ 63A	N40 . x - x - x - . WU2R1						
3-pole		60°	3	48 □ 20A	M10H . x x x x x ¹⁾ - . WU3	. WU3	
				32A	M20 . x x x x - - . WU3		
				64 □ 32A	N20 . x - x - x x . WU3		
				50A	N33F . x x x - x - . WU3		
				88 □ 63A	N40 . x - x - x - . WU3		
80A	N60 . x - x - x - . WU3						
115A	N80 . x - x - - - . WU3						
132 □ 150A	N100 . x - x - - - . WU3						
250A	N200 . x - x - - - . WU3						
3-pole with spring return from both sides to off		30°	3	48 □ 20A	M10H . x x x x x ¹⁾ - . WU3R2	. WU3R2	
				32A	M20 . x x x x - - . WU3R2		
				64 □ 32A	N20 . x - x - x x . WU3R2		
50A	N33F . x x x - x - . WU3R2						
88 □ 63A	N40 . x - x x - . WU3R2						
3-pole position 1 latched position 2 with spring return to off		60°+30°	3	48 □ 20A	M10H . x x x x x ¹⁾ - . WU3R1	. WU3R1	
				32A	M20 . x x x x - - . WU3R1		
				64 □ 32A	N20 . x - x - x x . WU3R1		
50A	N33F . x - x - x - . WU3R1						
88 □ 63A	N40 . x - x - x - . WU3R1						

Ordering example: AC21 63A base mounting, reversing switch 3-pole, position 2 with spring to off N40 V WU3R1

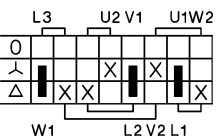
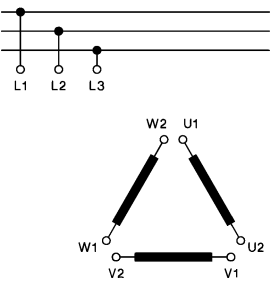
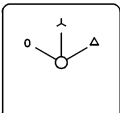
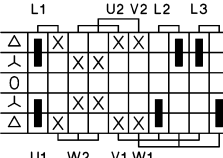
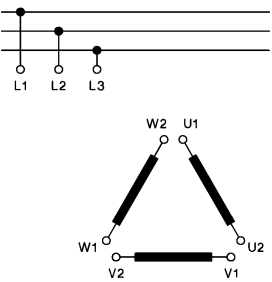
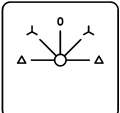
1) Plastic enclosed switches are delivered with switch type M10.

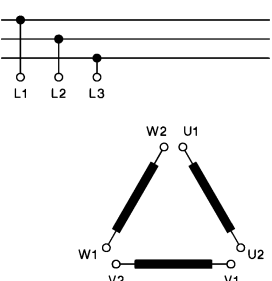
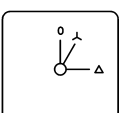
Switching programs

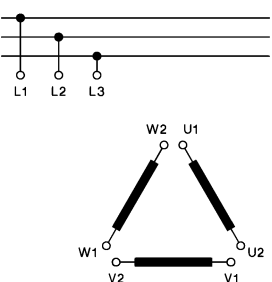
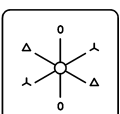
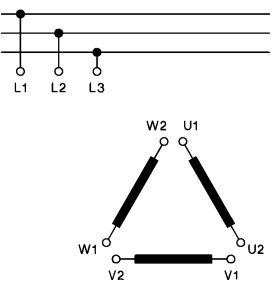
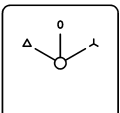
Description	Wiring diagram	Switching angle	Number of cells ↓ Size ↓ AC21	Type	Design see page 6-8 E. Z. V. SMA. P. G.	Switch pro- gram	Escutcheon plate
Star-Delta switches SD							
1 rotary direction 		60°	4	48 □ 20A 32A	M10H . x x x x x ¹⁾ - . M20 . x x x x - - .	. SD . SD	
				64 □ 32A 50A	N20 . x - x - x x . N33F . x - x - x - .	. SD . SD	
				88 □ 63A 80A 115A	N40 . x - x - x - . N60 . x - x - x - . N80 . x - x - - - .	. SD . SD . SD	
				132 □ 150A 250A	N100 . x - x - - - . N200 . x - x - - - .	. SD . SD	
both rotary directions 		45°	5	48 □ 20A 32A	M10H . x x x x x ¹⁾ - . M20 . x x x x - - .	. SDR . SDR	
				64 □ 32A 50A	N20 . x - x - x x . N33F . x - x - x - .	. SDR . SDR	
				88 □ 63A 80A 115A	N40 . x - x - x - . N60 . x - x - x - . N80 . x - x - - - .	. SDR . SDR . SDR	
				132 □ 150A 250A	N100 . x - x - - - . N200 . x - x - - - .	. SDR . SDR	
1 rotary direction spring return from  to off		°	4	48 □ 20A 32A	M10H . x x x x x ¹⁾ - . M20 . x x x x - - .	. SRD . SRD	
				64 □ 32A 50A	N20 . x - x - x x . N33F . x - x - x - .	. SRD . SRD	
				88 □ 63A 80A 115A	N40 . x - x - x - . N60 . x - x - x - . N80 . x - x - - - .	. SRD . SRD . SRD	
				132 □ 150A 250A	N100 . x - x - - - . N200 . x - x - - - .	. SRD . SRD	
1 rotary direction with clockwise operation and backswitch interlock 		60°	5	48 □ 20A 32A	M10H . x x x x x ¹⁾ - . M20 . x x x x - - .	. SDRU . SDRU	
				64 □ 32A 50A	N20 . x - x - x x . N33F . x - x - x - .	. SDRU . SDRU	
				88 □ 63A 80A 115A	N40 . x - x - x - . N60 . x - x - x - . N80 . x - x - - - .	. SDRU . SDRU . SDRU	
				132 □ 150A 250A	N100 . x - x - - - . N200 . x - x - - - .	. SDRU . SDRU	
Star-Delta selector switch		60°	4	48 □ 20A 32A	M10H . x x x x x ¹⁾ - . M20 . x x x x - - .	. SDU . SDU	
				64 □ 32A 50A	N20 . x - x - x x . N33F . x - x - x - .	. SDU . SDU	
				88 □ 63A 80A 115A	N40 . x - x - x - . N60 . x - x - x - . N80 . x - x - - - .	. SDU . SDU . SDU	
				132 □ 150A 250A	N100 . x - x - - - . N200 . x - x - - - .	. SDU . SDU	

Ordering example: AC21 32A cast enclosed, star-delta selector switch

N20 G SDU

1) Plastic enclosed switches are delivered with switch type M10.

Switching programs

Description	Wiring diagram	Switching angle	Number of cells ↓ Size ↓ AC21	Type	Design see page 6-8 E. Z. V. SMA. P. G.	Switch pro- gram	Escutcheon plate
with double outfeed phases for use with manual motor starter		60°	4	48 □ 20A 32A 64 □ 32A 50A 88 □ 63A 80A 115A 132 □ 150A 250A	M10H . x x x x x ¹⁾ - M20 . x x x x - - N20 . x - x - x x N33F . x - x - x - N40 . x - x - x - N60 . x - x - x - N80 . x - x - - - N100 . x - x - - - N200 . x - x - - -	.SDMO .SDMO .SDMO .SDMO .SDMO .SDMO .SDMO .SDMO .SDMO	
with auxiliary contacts for contactor control, without main contacts, automatic zero setting in event of mains break-down		90°	4	48 □ 20A 32A 64 □ 32A 50A 88 □ 63A 80A 115A 132 □ 150A 250A	M10H . x x x x x ¹⁾ - M20 . x x x x - - N20 . x - x - x x N33F . x - x - x - N40 . x - x - x - N60 . x - x - x - N80 . x - x - - - N100 . x - x - - - N200 . x - x - - -	.SDJ1 .SDJ1 .SDJ1 .SDJ1 .SDJ1 .SDJ1 .SDJ1 .SDJ1 .SDJ1	
with auxiliary contacts for contactor control, without main contacts, automatic zero setting in event of mains break-down, spring return to		90°+30°	4	48 □ 20A 32A 64 □ 32A 50A 88 □ 63A 80A 115A 132 □ 150A 250A	M10H . x x x x x ¹⁾ - M20 . x x x x - - N20 . x - x - x x N33F . x - x - x - N40 . x - x - x - N60 . x - x - x - N80 . x - x - - - N100 . x - x - - - N200 . x - x - - -	.SDJ2 .SDJ2 .SDJ2 .SDJ2 .SDJ2 .SDJ2 .SDJ2 .SDJ2 .SDJ2	
as type SDJ1 but for both rotary directions		60°	7	48 □ 20A 32A 64 □ 32A 50A 88 □ 63A 80A 115A 132 □ 150A 250A	M10H . x x x - - - M20 . x x x - - - N20 . x - x - x x N33F . x - x - - - N40 . x - x - x - N60 . x - x - - - N80 . x - x - - - N100 . x - x - - - N200 . x - x - - -	.SDRJ1 .SDRJ1 .SDRJ1 .SDRJ1 .SDRJ1 .SDRJ1 .SDRJ1 .SDRJ1 .SDRJ1	
with brake position (counter current braking) brake position is a momentary operation		45°+30°	5	48 □ 20A 32A 64 □ 32A 50A 88 □ 63A 80A 115A 132 □ 150A 250A	M10H . x x x x x ¹⁾ - M20 . x x x x - - N20 . x - x - x x N33F . x - x - x - N40 . x - x - x - N60 . x - x - x - N80 . x - x - - - N100 . x - x - - - N200 . x - x - - -	.SDB .SDB .SDB .SDB .SDB .SDB .SDB .SDB .SDB	

Ordering example: AC21 250A panel mounting star-delta switch with brake position **N200 E SDB**

1) Plastic enclosed switches are delivered with switch type M10.

Switching programs

Description	Wiring diagram	Switching angle	Number of cells ↓ Size ↓ AC21	Type	Design see page 6-8 E. Z. V. SMA. P. G.	Switch pro- gram	Escutcheon plate
-------------	----------------	-----------------	--	------	--	------------------------	---------------------

Multi speed switches P

<p>1 Dahlander winding 1 rotary direction</p>	<p>60°</p> <p>4</p> <p>48 □ 20A 32A</p> <p>64 □ 32A 50A</p> <p>88 □ 63A 80A 115A</p> <p>132 □ 150A 250A</p>	<p>M10H . x x x x x¹⁾ - . P61</p> <p>M20 . x x x x - - . P61</p> <p>N20 . x - x - x x . P61</p> <p>N33F . x - x - x - . P61</p> <p>N40 . x - x - x - . P61</p> <p>N60 . x - x - x - . P61</p> <p>N80 . x - x - - - . P61</p> <p>N100 . x - x - - - . P61</p> <p>N200 . x - x - - - . P61</p>	
<p>1 Dahlander winding 1 rotary direction</p>	<p>60°</p> <p>4</p> <p>48 □ 20A 32A</p> <p>64 □ 32A 50A</p> <p>88 □ 63A 80A 115A</p> <p>132 □ 150A 250A</p>	<p>M10H . x x x x x¹⁾ - . P62</p> <p>M20 . x x x x - - . P62</p> <p>N20 . x - x - x x . P62</p> <p>N33F . x - x - x - . P62</p> <p>N40 . x - x - x - . P62</p> <p>N60 . x - x - x - . P62</p> <p>N80 . x - x - - - . P62</p> <p>N100 . x - x - - - . P62</p> <p>N200 . x - x - - - . P62</p>	<p>+007</p>
<p>1 Dahlander winding both rotary directions</p>	<p>60°</p> <p>7</p> <p>48 □ 20A 32A</p> <p>64 □ 32A 50A</p> <p>88 □ 63A 80A 115A</p> <p>132 □ 150A 250A</p>	<p>M10H . x x x - - - . P61R</p> <p>M20 . x x x - - - . P61R</p> <p>N20 . x - x - x - . P61R</p> <p>N33F . x - x - - - . P61R</p> <p>N40 . x - x - x - . P61R</p> <p>N60 . x - x - - - . P61R</p> <p>N80 . x - x - - - . P61R</p> <p>N100 . x - x - - - . P61R</p> <p>N200 . x - x - - - . P61R</p>	
<p>1 Dahlander winding 1 rotary direction, clockwise operation</p>	<p>60°</p> <p>5</p> <p>48 □ 20A 32A</p> <p>64 □ 32A 50A</p> <p>88 □ 63A 80A 115A</p> <p>132 □ 150A 250A</p>	<p>M10H . x x x x x¹⁾ - . P61RU</p> <p>M20 . x x x x - - . P61RU</p> <p>N20 . x - x - x x . P61RU</p> <p>N33F . x - x - x - . P61RU</p> <p>N40 . x - x - x - . P61RU</p> <p>N60 . x - x - x - . P61RU</p> <p>N80 . x - x - - - . P61RU</p> <p>N100 . x - x - - - . P61RU</p> <p>N200 . x - x - - - . P61RU</p>	
<p>1 Dahlander winding 1 rotary direction, with auxiliary contacts for contactor control</p>	<p>60°</p> <p>5</p> <p>48 □ 20A 32A</p> <p>64 □ 32A 50A</p> <p>88 □ 63A 80A 115A</p> <p>132 □ 150A 250A</p>	<p>M10H . x x x x x¹⁾ - . P61J</p> <p>M20 . x x x x - - . P61J</p> <p>N20 . x - x - x x . P61J</p> <p>N33F . x - x - x - . P61J</p> <p>N40 . x - x - x - . P61J</p> <p>N60 . x - x - x - . P61J</p> <p>N80 . x - x - - - . P61J</p> <p>N100 . x - x - - - . P61J</p> <p>N200 . x - x - - - . P61J</p>	

Ordering example: AC21 32A cast enclosed, multi speed switch, 1 Dahlander winding, 1 rotary direction

N20 G P61

1) Plastic enclosed switches are delivered with switch type M10.

Switching programs

Description	Wiring diagram	Switching angle	Number of cells ↓ Size ↓ AC21	Type	Design see page 6-8 E. Z. V. SMA. P. G.	Switch pro- gram	Escutcheon plate	
Multi speed switches P								
open Dahlander winding 1 rotary direction low speed with star-delta-start 		45°	6 48 □ 20A 32A 64 □ 32A 50A 88 □ 63A 80A 115A 132 □ 150A 250A	M10H . x x x - x ¹⁾ - M20 . x x x - - -	N20 . x - x - x x N33F . x - x - x -	N40 . x - x - x - N60 . x - x - x - N80 . x - x - - -	N100 . x - x - - - N200 . x - x - - -	
open Dahlander winding both rotary directions low speed with star-delta-start 		30°	8 48 □ 20A 32A 64 □ 32A 50A 88 □ 63A 80A 115A 132 □ 150A 250A	M10H . x x x - - - M20 . x x x - - -	N20 . x - x - x - N33F . x - x - - -	N40 . x - x - x - N60 . x - x - - - N80 . x - x - - -	N100 . x - x - - - N200 . x - x - - -	
open Dahlander winding 1 rotary direction, low speed with star-delta-start, with additional start position (starting resistor) 		30°	7 48 □ 20A 32A 64 □ 32A 50A 88 □ 63A 80A 115A 132 □ 150A 250A	M10H . x x x - - - M20 . x x x - - -	N20 . x - x - x - N33F . x - x - - -	N40 . x - x - x - N60 . x - x - - - N80 . x - x - - -	N100 . x - x - - - N200 . x - x - - -	

Ordering example: AC21 250A panel mounting, multi speed switch, 1 rotary direction, low speed with star-delta-start

N200 E P91

1) Plastic enclosed switches are delivered with switch type M10.

Switching programs

Description	Wiring diagram	Switching angle	Number of cells ↓ Size ↓ AC21	Type	Design see page 6-8 E. Z. V. SMA. P. G.	Switch pro- gram	Escutcheon plate
-------------	----------------	-----------------	--	------	--	------------------------	---------------------

Multi speed switches P

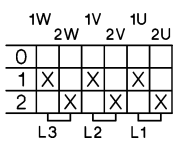
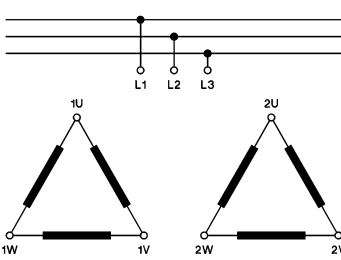
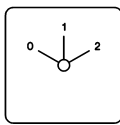
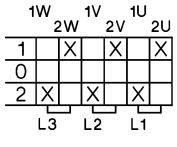
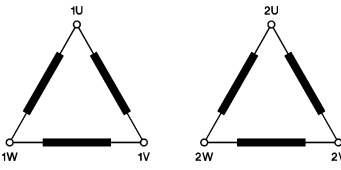
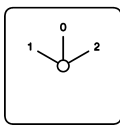
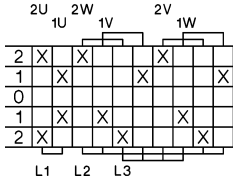
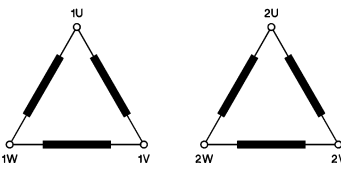
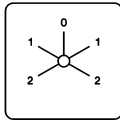
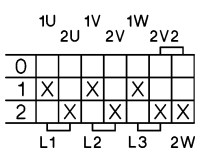
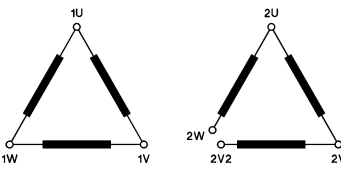
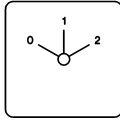
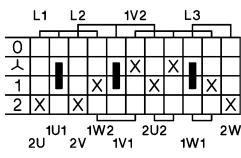
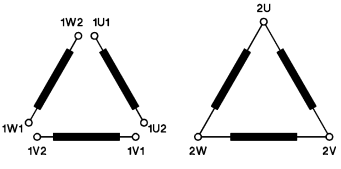
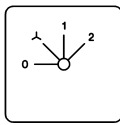
2 separate windings 1 rotary direction 		60°	3 48 □ 20A 32A	M10H . x x x x x ¹⁾ - . P63 M20 . x x x x - - . P63	
			64 □ 32A 50A	N20 . x - x - x x . P63 N33F . x - x - x - . P63	
			88 □ 63A 80A 115A	N40 . x - x - x - . P63 N60 . x - x - x - . P63 N80 . x - x - - - . P63	
			132 □ 150A 250A	N100 . x - x - - - . P63 N200 . x - x - - - . P63	
2 separate windings 1 rotary direction 		60°	3 48 □ 20A 32A	M10H . x x x x x ¹⁾ - . P64 M20 . x x x x - - . P64	
			64 □ 32A 50A	N20 . x - x - x x . P64 N33F . x - x - x - . P64	
			88 □ 63A 80A 115A	N40 . x - x - x - . P64 N60 . x - x - x - . P64 N80 . x - x - - - . P64	
			132 □ 150A 250A	N100 . x - x - - - . P64 N200 . x - x - - - . P64	
2 separate windings both rotary directions 		60°	5 48 □ 20A 32A	M10H . x x x x x ¹⁾ - . P66 M20 . x x x x - - . P66	
			64 □ 32A 50A	N20 . x - x - x x . P66 N33F . x - x - x - . P66	
			88 □ 63A 80A 115A	N40 . x - x - x - . P66 N60 . x - x - x - . P66 N80 . x - x - - - . P66	
			132 □ 150A 250A	N100 . x - x - - - . P66 N200 . x - x - - - . P66	
2 separate windings 1 opened 1 rotary direction 		60°	4 48 □ 20A 32A	M10H . x x x x x ¹⁾ - . P71 M20 . x x x x - - . P71	
			64 □ 32A 50A	N20 . x - x - x x . P71 N33F . x - x - x - . P71	
			88 □ 63A 80A 115A	N40 . x - x - x - . P71 N60 . x - x - x - . P71 N80 . x - x - - - . P71	
			132 □ 150A 250A	N100 . x - x - - - . P71 N200 . x - x - - - . P71	
2 separate windings 1 rotary direction low speed with star-delta-start 		45°	6 48 □ 20A 32A	M10H . x x x - x ¹⁾ - . P96 M20 . x x x - - - . P96	
			64 □ 32A 50A	N20 . x - x - x x . P96 N33F . x - x - x - . P96	
			88 □ 63A 80A 115A	N40 . x - x - x - . P96 N60 . x - x - x - . P96 N80 . x - x - - - . P96	
			132 □ 150A 250A	N100 . x - x - - - . P96 N200 . x - x - - - . P96	

Ordering example: AC21 250A panel mounting, multi speed switch, 2 separate windings, low speed with star-delta-start

N200 E P96

1) Plastic enclosed switches are delivered with switch type M10.

Switching programs

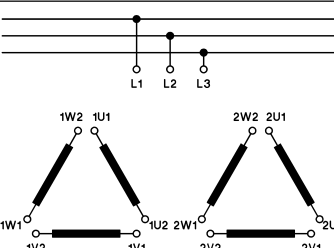
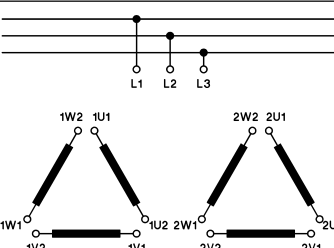
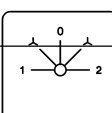
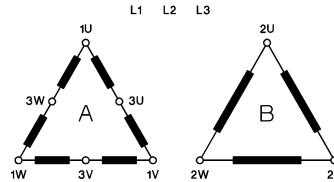
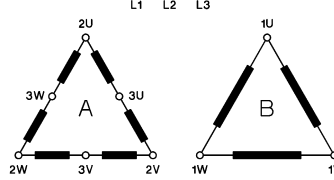
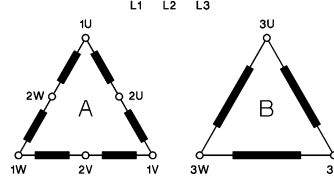
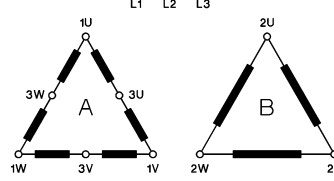
Description	Wiring diagram	Switching angle	Number of cells ↓ Size ↓ AC21	Type	Design see page 6-8 E. Z. V. SMA. P. G.	Switch pro- gram	Escutcheon plate
Multi speed switches P							
2 separate windings 1 rotary direction both speeds with star-delta-start 		45°	8	48 □ 20A 32A	M10H . x x x - - - . P122 M20 . x - x - - - . P122		
			64 □	32A 50A	N20 . x - x - x - . P122 N33F . x - x - - - . P122		
			88 □	63A 80A 115A	N40 . x - x - x - . P122 N60 . x - x - - - . P122 N80 . x - x - - - . P122		
			132 □	150A 250A	N100 . x - x - - - . P122 N200 . x - x - - - . P122		
			1 Dahlander winding A 1 normal winding B 3 speeds 1 rotary direction 0-A Δ-B Δ or Δ-A Δ		45°		6
64 □	32A 50A	N20 . x - x - x x . P93 N33F . x - x - x - . P93					
88 □	63A 80A 115A	N40 . x - x - x - . P93 N60 . x - x - x - . P93 N80 . x - x - - - . P93					
132 □	150A 250A	N100 . x - x - - - . P93 N200 . x - x - - - . P93					
1 Dahlander winding A 1 normal winding B 3 speeds 1 rotary direction 0-B Δ or Δ-A Δ		45°	6			48 □ 20A 32A	M10H . x x x - x ¹⁾ - . P94 M20 . x x x - - - . P94
64 □			32A 50A	N20 . x - x - x - . P94 N33F . x - x - x - . P94			
88 □			63A 80A 115A	N40 . x - x - x - . P94 N60 . x - x - x - . P94 N80 . x - x - - - . P94			
132 □			150A 250A	N100 . x - x - - - . P94 N200 . x - x - - - . P94			
1 Dahlander winding A 1 normal winding B 3 speeds 1 rotary direction 0-A Δ-A Δ-B Δ or Δ				45°	6	48 □ 20A 32A	M10H . x x x - x ¹⁾ - . P95 M20 . x x x - - - . P95
64 □	32A 50A	N20 . x - x - x x . P95 N33F . x - x - x - . P95					
88 □	63A 80A 115A	N40 . x - x - x - . P95 N60 . x - x - x - . P95 N80 . x - x - - - . P95					
132 □	150A 250A	N100 . x - x - - - . P95 N200 . x - x - - - . P95					
1 Dahlander winding A 1 normal winding B 3 speeds both rotary directions		45°			9	48 □ 20A 32A	M10H . x x x - - - . P93R M20 . x x x - - - . P93R
64 □			32A 50A	N20 . x - x - - - . P93R N33F . x - x - - - . P93R			
88 □			63A 80A 115A	N40 . x - x - - - . P93R N60 . x - x - - - . P93R N80 . x - x - - - . P93R			
132 □			150A 250A	N100 . x - x - - - . P93R N200 . x - x - - - . P93R			

Ordering example: AC21 250A panel mounting, multi speed switch, 1 Dahlander winding A,
1 normal winding B, 3 speeds, both rotary directions **N200 E P93R**

1) Plastic enclosed switches are delivered with switch type M10.

Switching programs

Description	Wiring diagram	Switching angle	Number of cells ↓ Size ↓ AC21	Type	Design see page 6-8 E. Z. V. SMA. P. G.	Switch pro- gram	Escutcheon plate
-------------	----------------	-----------------	--	------	--	------------------------	---------------------

Multi speed switches P

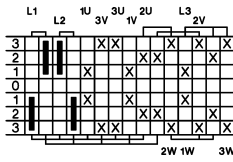
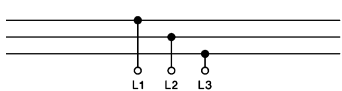
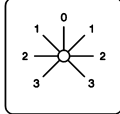
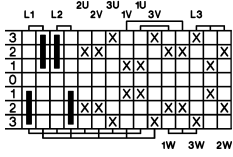
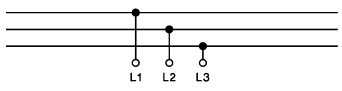
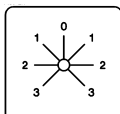
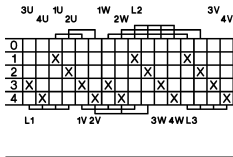
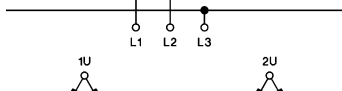
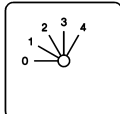
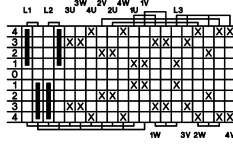
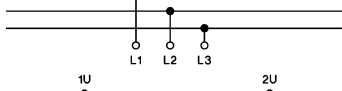
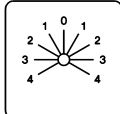
<p>1 Dahlander winding A 1 normal winding B 3 speeds both rotary directions</p> 		<p>45°</p>	<p>9 48 □ 20A 32A</p>	<p>M10H . x x x - - - . P94R M20 . x x x - - - . P94R</p>	
			<p>64 □ 32A 50A</p>	<p>N20 . x - x - - - . P94R N33F . x - x - - - . P94R</p>	
			<p>88 □ 63A 80A 115A</p>	<p>N40 . x - x - - - . P94R N60 . x - x - - - . P94R N80 . x - x - - - . P94R</p>	
			<p>132 □ 150A 250A</p>	<p>N100 . x - x - - - . P94R N200 . x - x - - - . P94R</p>	
<p>1 Dahlander winding A 1 normal winding B 3 speeds both rotary directions</p> 		<p>45°</p>	<p>8 48 □ 20A 32A</p>	<p>M10H . x x x - - - . P95R M20 . x x x - - - . P95R</p>	
			<p>64 □ 32A 50A</p>	<p>N20 . x - x - x - . P95R N33F . x - x - - - . P95R</p>	
			<p>88 □ 63A 80A 115A</p>	<p>N40 . x - x - x - . P95R N60 . x - x - - - . P95R N80 . x - x - - - . P95R</p>	
			<p>132 □ 150A 250A</p>	<p>N100 . x - x - - - . P95R N200 . x - x - - - . P95R</p>	
<p>2 Dahlander windings 4 speeds 1 rotary direction 0 - A Δ - B Δ - A Δ - B Δ</p> 		<p>30°</p>	<p>8 48 □ 20A 32A</p>	<p>M10H . x x x - - - . P124 M20 . x x x - - - . P124</p>	
			<p>64 □ 32A 50A</p>	<p>N20 . x - x - x - . P124 N33F . x - x - - - . P124</p>	
			<p>88 □ 63A 80A 115A</p>	<p>N40 . x - x - x - . P124 N60 . x - x - - - . P124 N80 . x - x - - - . P124</p>	
			<p>132 □ 150A 250A</p>	<p>N100 . x - x - - - . P124 N200 . x - x - - - . P124</p>	
<p>2 Dahlander windings 4 speeds both rotary directions</p> 		<p>30°</p>	<p>12 48 □ 20A 32A</p>	<p>M10H . x x x - - - . P124R M20 . x x x - - - . P124R</p>	
			<p>64 □ 32A 50A</p>	<p>N20 . x - x - - - . P124R N33F . x - x - - - . P124R</p>	
			<p>88 □ 63A 80A 115A</p>	<p>N40 . x - x - - - . P124R N60 . x - x - - - . P124R N80 . x - x - - - . P124R</p>	
			<p>132 □ 150A 250A</p>	<p>N100 . x - x - - - . P124R N200 . x - x - - - . P124R</p>	

Ordering example: AC21 250A Base mounting, multi speed switch, 2 Dahlander windings, 4 speeds, 1 rotary direction

N200 V P124

Switching programs

Description	Wiring diagram	Switching angle	Number of cells ↓ Size ↓ AC21	Type	Design see page 6-8 E. Z. V. SMA. P. G.	Switch pro- gram	Escutcheon plate
-------------	----------------	-----------------	---	------	---	------------------------	---------------------

Changeover switches with spring return to off UR

1-pole		30°	1 48 □ 20A	M10H . x x x x x ¹⁾ - . UR1 M20 . x x x x - - . UR1	
			64 □ 32A	N20 . x - x - x x . UR1 N33F . x - x - x - . UR1	
			88 □ 63A	N40 . x - x - x - . UR1	
+264					
2-pole		30°	2 48 □ 20A	M10H . x x x x x ¹⁾ - . UR2 M20 . x x x x - - . UR2	
			64 □ 32A	N20 . x - x - x x . UR2 N33F . x - x - x - . UR2	
			88 □ 63A	N40 . x - x - x - . UR2	
+264					
3-pole		30°	3 48 □ 20A	M10H . x x x x x ¹⁾ - . UR3 M20 . x x x x - - . UR3	
			64 □ 32A	N20 . x - x - x x . UR3 N33F . x - x - x - . UR3	
			88 □ 63A	N40 . x - x - x - . UR3	
+264					

Changeover switches with 1 latched and 1 momentary position UK

1-pole position 1 latched position 2 with spring return		60°+30°	1 48 □ 20A	M10H . x x x x x ¹⁾ - . UK1 M20 . x x x x - - . UK1	
			64 □ 32A	N20 . x - x - x x . UK1 N33F . x - x - x - . UK1	
			88 □ 63A	N40 . x - x - x - . UK1	
2-pole position 1 latched position 2 with spring return		60°+30°	2 48 □ 20A	M10H . x x x x x ¹⁾ - . UK2 M20 . x x x x - - . UK2	
			64 □ 32A	N20 . x - x - x x . UK2 N33F . x - x - x - . UK2	
			88 □ 63A	N40 . x - x - x - . UK2	
3-pole position 1 latched position 2 with spring return		60°+30°	3 48 □ 20A	M10H . x x x x x ¹⁾ - . UK3 M20 . x x x x - - . UK3	
			64 □ 32A	N20 . x - x - x x . UK3 N33F . x - x - x - . UK3	
			88 □ 63A	N40 . x - x - x - . UK3	

Ordering example: AC21 63A panel mounting, changeover switch, position 1 latched, position 2 with spring return, 3-pole: **N40 E UK3**

1) Plastic enclosed switches are delivered with switch type M10.

Switching programs

Description	Wiring diagram	Switching angle	Number of cells ↓ Size ↓ AC21	Type	Design see page 6-8 E. Z. V. SMA. P. G.	Switch pro- gram	Escutcheon plate
-------------	----------------	-----------------	---	------	---	------------------------	---------------------

Double throw switches with spring return to off WR

1-pole		30°	1 48 □ 20A	M10H . x x x x x ¹⁾ - . W1R	
			32A	M20 . x x x x - - . W1R	
			64 □ 32A	N20 . x - x - x x . W1R	
			50A	N33F . x - x - x - . W1R	
			88 □ 63A	N40 . x - x - x - . W1R	
2-pole		30°	2 48 □ 20A	M10H . x x x x x ¹⁾ - . W2R	
			32A	M20 . x x x x - - . W2R	
			64 □ 32A	N20 . x - x - x x . W2R	
			50A	N33F . x - x - x - . W2R	
			88 □ 63A	N40 . x - x - x - . W2R	
3-pole		30°	3 48 □ 20A	M10H . x x x x x ¹⁾ - . W3R	
			32A	M20 . x x x x - - . W3R	
			64 □ 32A	N20 . x - x - x x . W3R	
			50A	N33F . x - x - x - . W3R	
			88 □ 63A	N40 . x - x - x - . W3R	

Start-Stop switches S

Start-switch, 1-pole		30°	1 48 □ 20A	M10H . x x x x x ¹⁾ - . SE	
			32A	M20 . x x x x - - . SE	
			64 □ 32A	N20 . x - x - x x . SE	
			50A	N33F . x - x - x - . SE	
Start-switch, 2-pole		30°	1 48 □ 20A	M10H . x x x x x ¹⁾ - . S2E	
			32A	M20 . x x x x - - . S2E	
			64 □ 32A	N20 . x - x - x x . S2E	
			50A	N33F . x - x - x - . S2E	
Start-switch, 3-pole		30°	2 48 □ 20A	M10H . x x x x x ¹⁾ - . S3E	
			32A	M20 . x x x x - - . S3E	
			64 □ 32A	N20 . x - x - x x . S3E	
			50A	N33F . x - x - x - . S3E	

Bestellbeispiel: AC21 50A base mounting, Start-switch, 3-pole

N33F V S3E

1) Plastic enclosed switches are delivered with switch type M10.

Switching programs

Description	Wiring diagram	Switching angle	Number of cells ↓ Size ↓ AC21	Type	Design see page 6-8 E. Z. V. SMA. P. G.	Switch pro- gram	Escutcheon plate
Start-Stop switches S							
Stop-switch, 1-pole		30°	1 48 □ 20A 32A 64 □ 32A 50A 88 □ 63A	M10H . x x x x x ¹⁾ - M20 . x x x x - -	N20 . x - x - x x N33F . x - x - x -	. SA . SA . SA . SA	
Stop-switch, 2-pole		30°	1 48 □ 20A 32A 64 □ 32A 50A 88 □ 63A	M10H . x x x x x ¹⁾ - M20 . x x x x - -	N20 . x - x - x x N33F . x - x - x -	. S2A . S2A . S2A . S2A	
Stop-switch, 3-pole		30°	2 48 □ 20A 32A 64 □ 32A 50A 88 □ 63A	M10H . x x x x x ¹⁾ - M20 . x x x x - -	N20 . x - x - x x N33F . x - x - x -	. S3A . S3A . S3A . S3A	
Start-Stop-switch, 1-pole		30°	1 48 □ 20A 32A 64 □ 32A 50A	M10H . x x x x x ¹⁾ - M20 . x x x x - -	N20 . x - x - x x N33F . x - x - x -	. SEA . SEA . SEA . SEA	
Start-Stop-switch, 1-pole position START with spring return to 1		90°+30°	1 48 □ 20A 32A 64 □ 32A 50A	M10H . x x x x x ¹⁾ - M20 . x x x x - -	N20 . x - x - x x N33F . x - x - x -	. S392 . S392 . S392 . S392	
Start-Stop-switch, 1-pole for reversing contactors		60°+30°	2 48 □ 20A 32A 64 □ 32A 50A	M10H . x x x x x ¹⁾ - M20 . x x x x - -	N20 . x - x - x x N33F . x - x - x -	. S2EA . S2EA . S2EA . S2EA	
Start-Stop-switch, 1-pole for reversing contactors with limit switches		30°	2 48 □ 20A 32A 64 □ 32A 50A	M10H . x x x x x ¹⁾ - M20 . x x x x - -	N20 . x - x - x x N33F . x - x - x -	. S22 . S22 . S22 . S22	

Ordering example: AC21 50A panel mounting, Start-Stop-switch, 1-pole for reversing contactors

N33F E S2EA

1) Plastic enclosed switches are delivered with switch type M10.

Switching programs

Description	Wiring diagram	Switching angle	Number of cells ↓ Size ↓ AC21	Type	Design see page 6-8 E. Z. V. SMA. P. G.	Switch pro- gram	Escutcheon plate
-------------	----------------	-----------------	--	------	--	------------------------	---------------------

Voltmeter selector switches V

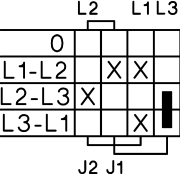
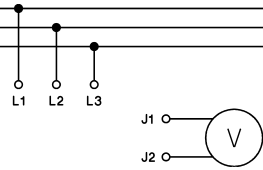
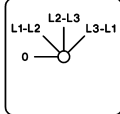
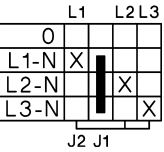
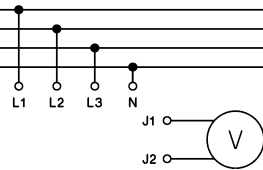
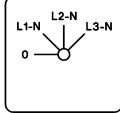
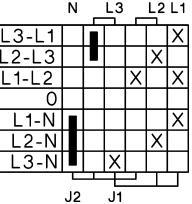
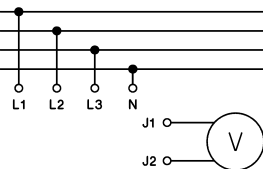
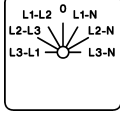
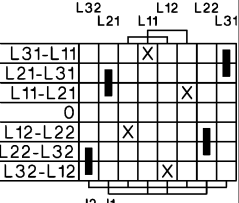
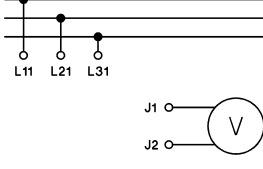
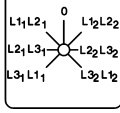
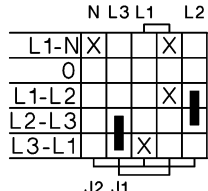
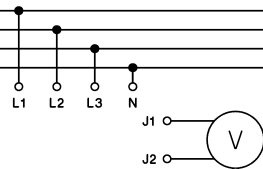
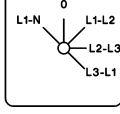
3 line voltages 		45°	2 48 □ 20A 32A 64 □ 32A 50A	M10H . x x x x x ¹⁾ - . V3 M20 . x x x x - - . V3 N20 . x - x - x x . V3 N33F . x x x - x - . V3	
3 phase voltages 		45°	2 48 □ 20A 32A 64 □ 32A 50A	M10H . x x x x x ¹⁾ - . V0 M20 . x x x x - - . V0 N20 . x - x - x x . V0 N33F . x x x - x - . V0	
3 line voltages and 3 phase voltages 		30°	3 48 □ 20A 32A 64 □ 32A 50A	M10H . x x x x x ¹⁾ - . V1 M20 . x x x x - - . V1 N20 . x - x - x x . V1 N33F . x x x - x - . V1	
2 3-phase systems 2 x 3 line voltages 		45°	4 48 □ 20A 32A 64 □ 32A 50A	M10H . x x x x x ¹⁾ - . V32 M20 . x x x x - - . V32 N20 . x - x - x x . V32 N33F . x - x - x - . V32	
3 line voltages and 1 phase voltage 		45°	3 48 □ 20A 32A 64 □ 32A 50A	M10H . x x x x x ¹⁾ - . V13 M20 . x x x x - - . V13 N20 . x - x - x x . V13 N33F . x x x - x - . V13	

Ordering example: AC21 50A panel mounting, Voltmeter selector switch, 3 line voltages and 1 phase voltage

N33F E V13

1) Plastic enclosed switches are delivered with switch type M10.

Switching programs

Description	Wiring diagram	Switching angle	Number of cells ↓ Size ↓ AC21	Type	Design see page 6-8 E. Z. V. SMA. P. G.	Switch pro- gram	Escutcheon plate
Ammeter selector switches M							
1-pole, for current transformer		90°	1	48 □ 20A 32A	M10H . x x x x x ¹⁾ - . M11 M20 . x x x x - - . M11		
				64 □ 32A 50A	N20 . x - x - x x . M11 N33F . x x x - x - . M11		
				88 □ 63A	N40 . x - x - x - . M11		
2-pole, for 1 current transformer or direct current measurement		90°	2	48 □ 20A 32A	M10H . x x x x x ¹⁾ - . M12 M20 . x x x x - - . M12		
				64 □ 32A 50A	N20 . x - x - x x . M12 N33F . x x x - x - . M12		
				88 □ 63A 80A 115A	N40 . x - x - x - . M12 N60 . x - x - x - . M12 N80 . x - x - - - . M12		
				132 □ 150A 250A	N100 . x - x - - - . M12 N200 . x - x - - - . M12		
1-pole, for 2 current transformers		90°	2	48 □ 20A 32A	M10H . x x x x x ¹⁾ - . M21 M20 . x x x x - - . M21		
				64 □ 32A 50A	N20 . x - x - x x . M21 N33F . x x x - x - . M21		
				88 □ 63A	N40 . x - x - x - . M21		
2-pole, for 2 current transformers or direct current measurement in 2 phases		90°	3	48 □ 20A 32A	M10H . x x x x x ¹⁾ - . M22 M20 . x x x x - - . M22		
				64 □ 32A 50A	N20 . x - x - x x . M22 N33F . x x x - x - . M22		
				88 □ 63A 80A 115A	N40 . x - x - x - . M22 N60 . x - x - x - . M22 N80 . x - x - - - . M22		
				132 □ 150A 250A	N100 . x - x - - - . M22 N200 . x - x - - - . M22		
1-pole, for 3 current transformers		90°	3	48 □ 20A 32A	M10H . x x x x x ¹⁾ - . M31 M20 . x x x x - - . M31		
				64 □ 32A 50A	N20 . x - x - x x . M31 N33F . x - x - x - . M31		
				88 □ 63A	N40 . x - x - x - . M31		

Ordering example: AC21 63A panel mounting, ammeter selector switch, for 3 current transformers 1-pole

N40 V M31

1) Plastic enclosed switches are delivered with switch type M10.

Switching programs

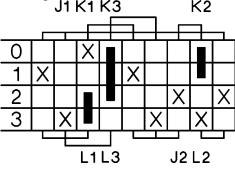
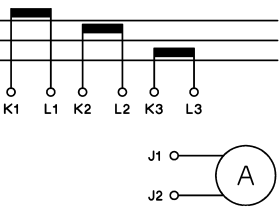
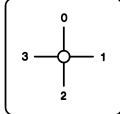
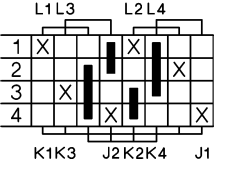
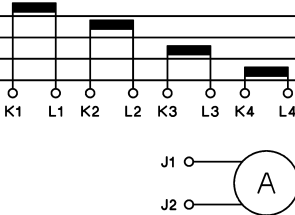
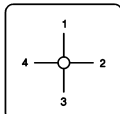
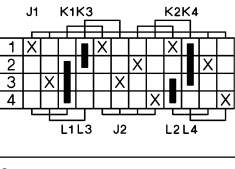
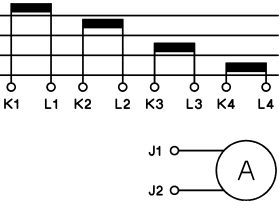
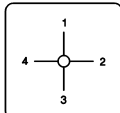
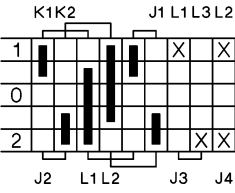
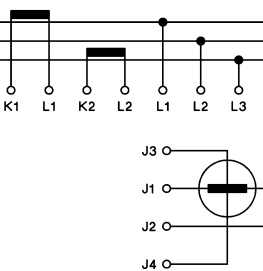
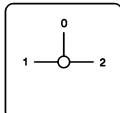
Description	Wiring diagram	Switching angle	Number of cells ↓ Size ↓ AC21	Type	Design see page 6-8 E. Z. V. SMA. P. G.	Switch pro- gram	Escutcheon plate
2-pole, for 3 current transformers or direct current measurement in 3 phases 		90°	6 48 □ 20A	M10H . x x x x x ¹⁾ - . M32 M20 . x x x - - - . M32			
			64 □ 32A	N20 . x - x - x x . M32 N33F . x - x - x - . M32			
			88 □ 63A	N40 . x - x - x - . M32 N60 . x - x - x - . M32 N80 . x - x - - - . M32			
			132 □ 150A	N100 . x - x - - - . M32 N200 . x - x - - - . M32			
			250A	N100 . x - x - - - . M32 N200 . x - x - - - . M32			
1-pole, for 4 current transformers 		90°	4 48 □ 20A	M10H . x x x x x ¹⁾ - . M41 M20 . x x x x - - . M41			
			64 □ 32A	N20 . x - x - x x . M41 N33F . x - x - x - . M41			
			88 □ 63A	N40 . x - x - x - . M41			
2-pole, for 4 current transformers or direct current measurement in 4 phases 		90°	6 48 □ 20A	M10H . x x x x x ¹⁾ - . M42 M20 . x x x x - - . M42			
			64 □ 32A	N20 . x - x - x x . M42 N33F . x - x - x - . M42			
			88 □ 63A	N40 . x - x - x - . M42 N60 . x - x - x - . M42 N80 . x - x - - - . M42			
			132 □ 150A	N100 . x - x - - - . M42 N200 . x - x - - - . M42			
			250A	N100 . x - x - - - . M42 N200 . x - x - - - . M42			
f. output measurement in 3-phase systems by 2-wattmeter method 		90°	5 48 □ 20A	M10H . x x x x x ¹⁾ - . M2W M20 . x x x x - - . M2W			
			64 □ 32A	N20 . x - x - x x . M2W N33F . x - x - x - . M2W			
			88 □ 63A	N40 . x - x - x - . M2W N60 . x - x - x - . M2W N80 . x - x - - - . M2W			
			132 □ 150A	N100 . x - x - - - . M2W N200 . x - x - - - . M2W			
			250A	N100 . x - x - - - . M2W N200 . x - x - - - . M2W			

Ordering example: AC21 63A panel mounting, ammeter selector switch, for 4 current transformers 1-pole

N40 V M41

1) Plastic enclosed switches are delivered with switch type M10.

Switching programs

Description	Wiring diagram	Switching angle	Number of cells ↓ Size ↓ AC21	Type	Design see page 6-8 E. Z. V. SMA. P. G.	Switch pro- gram	Escutcheon plate
2 circuits A and B 1-pole 0 - A - A+B		45°	1 48 □ 20A 32A 64 □ 32A 50A 88 □ 63A 80A 115A 132 □ 150A 250A	M10H . x x x x x ¹⁾ - . GR11 M20 . x x x x - - . GR11 N20 . x - x - x x . GR11 N33F . x x x - x - . GR11 N40 . x - x - x - . GR11 N60 . x - x - x - . GR11 N80 . x - x - - - . GR11 N100 . x - x - - - . GR11 N200 . x - x - - - . GR11			
2 circuits A and B 1-pole 0 - A - B - A+B		45°	1 48 □ 20A 32A 64 □ 32A 50A 88 □ 63A 80A 115A 132 □ 150A 250A	M10H . x x x x x ¹⁾ - . GR12 M20 . x x x x - - . GR12 N20 . x - x - x x . GR12 N33F . x x x - x - . GR12 N40 . x - x - x - . GR12 N60 . x - x - x - . GR12 N80 . x - x - - - . GR12 N100 . x - x - - - . GR12 N200 . x - x - - - . GR12			
2 circuits A and B 2-pole 0 - A - A+B		45°	2 48 □ 20A 32A 64 □ 32A 50A 88 □ 63A 80A 115A 132 □ 150A 250A	M10H . x x x x x ¹⁾ - . GR21 M20 . x x x x - - . GR21 N20 . x - x - x x . GR21 N33F . x x x - x - . GR21 N40 . x - x - x - . GR21 N60 . x - x - x - . GR21 N80 . x - x - - - . GR21 N100 . x - x - - - . GR21 N200 . x - x - - - . GR21			
2 circuits A and B 2-pole 0 - A - B - A+B		45°	2 48 □ 20A 32A 64 □ 32A 50A 88 □ 63A 80A 115A 132 □ 150A 250A	M10H . x x x x x ¹⁾ - . GR22 M20 . x x x x - - . GR22 N20 . x - x - x x . GR22 N33F . x x x - x - . GR22 N40 . x - x - x - . GR22 N60 . x - x - x - . GR22 N80 . x - x - - - . GR22 N100 . x - x - - - . GR22 N200 . x - x - - - . GR22			
2 circuits A and B 3-pole 0 - A - A+B		45°	3 48 □ 20A 32A 64 □ 32A 50A 88 □ 63A 80A 115A 132 □ 150A 250A	M10H . x x x x x ¹⁾ - . GR31 M20 . x x x x - - . GR31 N20 . x - x - x x . GR31 N33F . x - x - x - . GR31 N40 . x - x - x x . GR31 N60 . x - x - x - . GR31 N80 . x - x - - - . GR31 N100 . x - x - - - . GR31 N200 . x - x - - - . GR31			

Ordering example: AC21 250A panel mounting, gang switch, 2 circuits A and B, 3-pole

N200 E GR31

1) Plastic enclosed switches are delivered with switch type M10.

Switching programs

Description	Wiring diagram	Switching angle	Number of cells ↓ Size ↓ AC21	Type	Design see page 6-8 E. Z. V. SMA. P. G.	Switch pro- gram	Escutcheon plate
2 circuits A and B 3-pole 0 - A - B - A+B 		45°	3 48 □ 20A 32A 64 □ 32A 50A 88 □ 63A 80A 115A 132 □ 150A 250A	M10H . x x x x x ¹⁾ - . GR32 M20 . x x x x - - . GR32 N20 . x - x - x x . GR32 N33F . x - x - x - . GR32 N40 . x - x - x - . GR32 N60 . x - x - x - . GR32 N80 . x - x - - - . GR32 N100 . x - x - - - . GR32 N200 . x - x - - - . GR32			
3 circuits A, B and C 1-pole 0 - A - A+B - A+B+C 		45°	2 48 □ 20A 32A 64 □ 32A 50A 88 □ 63A 80A 115A 132 □ 150A 250A	M10H . x x x x x ¹⁾ - . GR14 M20 . x x x x - - . GR14 N20 . x - x - x x . GR14 N33F . x - x - x - . GR14 N40 . x - x - x - . GR14 N60 . x - x - x - . GR14 N80 . x - x - - - . GR14 N100 . x - x - - - . GR14 N200 . x - x - - - . GR14			
3 circuits A, B and C 2-pole 0 - A - A+B - A+B+C 		45°	3 48 □ 20A 32A 64 □ 32A 50A 88 □ 63A 80A 115A 132 □ 150A 250A	M10H . x x x x x ¹⁾ - . GR23 M20 . x x x x - - . GR23 N20 . x - x - x x . GR23 N33F . x - x - x - . GR23 N40 . x - x - x - . GR23 N60 . x - x - x - . GR23 N80 . x - x - - - . GR23 N100 . x - x - - - . GR23 N200 . x - x - - - . GR23			
3 circuits A, B and C 3-pole 0 - A - A+B - A+B+C 		45°	5 48 □ 20A 32A 64 □ 32A 50A 88 □ 63A 80A 115A 132 □ 150A 250A	M10H . x x x x x ¹⁾ - . GR33 M20 . x x x x - - . GR33 N20 . x - x - x x . GR33 N33F . x - x - x - . GR33 N40 . x - x - x - . GR33 N60 . x - x - x - . GR33 N80 . x - x - - - . GR33 N100 . x - x - - - . GR33 N200 . x - x - - - . GR33			

Ordering example: AC21 250A panel mounting, gang switch, 3 circuits A, B and C, 3-pole **N200 E GR33**

1) Plastic enclosed switches are delivered with switch type M10.

Switching programs

Description	Wiring diagram	Switching angle	Number of cells ↓ Size ↓ AC21	Type	Design see page 6-8 E. Z. V. SMA. P. G.	Switch pro- gram	Escutcheon plate	
Series-Parallel switches SP								
2 circuits A and B 2-pole 0 - A + B - A,B (parallel)		45°	2	48 □ 20A	M10H . x x x x x ¹⁾ - . SP1	. SP1		
				32A	M20 . x x x x - - . SP1			+126
				64 □ 32A	N20 . x - x - x x . SP1			
				50A	N33F . x x x - x - . SP1			
2 circuits A and B 2-pole 0 - A,B (parall.) - A - A+B		90°	3	48 □ 20A	M10H . x x x x x ¹⁾ - . SP4	. SP4		
				32A	M20 . x x x x - - . SP4			+270
				64 □ 32A	N20 . x - x - x x . SP4			
				50A	N33F . x x x - x - . SP4			
2 circuits A and B for 3-phase systems 0 - A+B - A - B - A,B		30°	2	48 □ 20A	M10H . x x x x x ¹⁾ - . SP3	. SP3		
				32A	M20 . x x x x - - . SP3			+112
				64 □ 32A	N20 . x - x - x x . SP3			
				50A	N33F . x x x - x - . SP3			
2 circuits A and B for 3-phase systems 0 - A+B - A - B - A,B		30°	2	88 □ 63A	N40 . x - x - x - . SP3	. SP3		
				80A	N60 . x - x - x - . SP3			
				115A	N80 . x - x - - - . SP3			
				132 □ 150A	N100 . x - x - - - . SP3			
250A	N200 . x - x - - - . SP3							

Ordering example: AC21 250A panel mounting, series-parallel switch, 2 circuits for 3-phase systems **N200 E SP3**

1) Plastic enclosed switches are delivered with switch type M10.

Switching programs

Description	Wiring diagram	Switching angle	Number of cells ↓ Size ↓ AC21	Type	Design see page 6-8 E. Z. V. SMA. P. G.	Switch pro- gram	Escutcheon plate
Multi step switches 1-pole without Off ST.1							
3 steps		60°	2	48 □ 20A	M10H . x x x x x ¹⁾ -	. ST31	
				32A	M20 . x x x x - -	. ST31	
				64 □ 32A	N20 . x - x - x x	. ST31	
				50A	N33F . x x x - x -	. ST31	
				88 □ 63A	N40 . x - x - x -	. ST31	
80A	N60 . x - x - x -	. ST31					
115A	N80 . x - x - - -	. ST31					
132 □ 150A	N100 . x - x - - -	. ST31					
250A	N200 . x - x - - -	. ST31					
4 steps		60°	2	48 □ 20A	M10H . x x x x x ¹⁾ -	. ST41	
				32A	M20 . x x x x - -	. ST41	
				64 □ 32A	N20 . x - x - x x	. ST41	
				50A	N33F . x x x - x -	. ST41	
				88 □ 63A	N40 . x - x - x -	. ST41	
80A	N60 . x - x - x -	. ST41					
115A	N80 . x - x - - -	. ST41					
132 □ 150A	N100 . x - x - - -	. ST41					
250A	N200 . x - x - - -	. ST41					
5 steps		60°	3	48 □ 20A	M10H . x x x x x ¹⁾ -	. ST51	
				32A	M20 . x x x x - -	. ST51	
				64 □ 32A	N20 . x - x - x x	. ST51	
				50A	N33F . x x x - x -	. ST51	
				88 □ 63A	N40 . x - x - x -	. ST51	
80A	N60 . x - x - x -	. ST51					
115A	N80 . x - x - - -	. ST51					
132 □ 150A	N100 . x - x - - -	. ST51					
250A	N200 . x - x - - -	. ST51					
6 steps		60°	3	48 □ 20A	M10H . x x x x x ¹⁾ -	. ST61	
				32A	M20 . x x x x - -	. ST61	
				64 □ 32A	N20 . x - x - x x	. ST61	
				50A	N33F . x x x - x -	. ST61	
				88 □ 63A	N40 . x - x - x -	. ST61	
80A	N60 . x - x - x -	. ST61					
115A	N80 . x - x - - -	. ST61					
132 □ 150A	N100 . x - x - - -	. ST61					
250A	N200 . x - x - - -	. ST61					
7 steps		45°	4	48 □ 20A	M10H . x x x x x ¹⁾ -	. ST71	
				32A	M20 . x x x x - -	. ST71	
				64 □ 32A	N20 . x - x - x x	. ST71	
				50A	N33F . x - x - x -	. ST71	
				88 □ 63A	N40 . x - x - x -	. ST71	
80A	N60 . x - x - x -	. ST71					
115A	N80 . x - x - - -	. ST71					
132 □ 150A	N100 . x - x - - -	. ST71					
250A	N200 . x - x - - -	. ST71					

Ordering example: AC21 250A panel mounting, multi step switch 1-pole without off, 7 steps **N200 E ST71**

1) Plastic enclosed switches are delivered with switch type M10.

Switching programs

Description	Wiring diagram	Switching angle	Number of cells ↓ Size ↓ AC21	Type	Design see page 6-8 E. Z. V. SMA. P. G.	Switch pro- gram	Escutcheon plate
Multi step switches 1-pole without Off ST.1							
8 steps		45°	4	48 □ 20A	M10H . x x x x x ¹⁾ - . ST81		
				32A	M20 . x x x x - - . ST81		
				64 □ 32A	N20 . x - x - x x . ST81		
				50A	N33F . x - x - x - . ST81		
				88 □ 63A	N40 . x - x - x - . ST81		
80A	N60 . x - x - x - . ST81						
115A	N80 . x - x - - - . ST81						
132 □ 150A	N100 . x - x - - - . ST81						
250A	N200 . x - x - - - . ST81						
9 steps		30°	5	48 □ 20A	M10H . x x x x x ¹⁾ - . ST91		
				32A	M20 . x x x x - - . ST91		
				64 □ 32A	N20 . x - x - x x . ST91		
				50A	N33F . x - x - x - . ST91		
				88 □ 63A	N40 . x - x - x - . ST91		
80A	N60 . x - x - x - . ST91						
115A	N80 . x - x - - - . ST91						
132 □ 150A	N100 . x - x - - - . ST91						
250A	N200 . x - x - - - . ST91						
10 steps		30°	5	48 □ 20A	M10H . x x x x x ¹⁾ - . ST101		
				32A	M20 . x x x x - - . ST101		
				64 □ 32A	N20 . x - x - x x . ST101		
				50A	N33F . x - x - x - . ST101		
				88 □ 63A	N40 . x - x - x - . ST101		
80A	N60 . x - x - x - . ST101						
115A	N80 . x - x - - - . ST101						
132 □ 150A	N100 . x - x - - - . ST101						
250A	N200 . x - x - - - . ST101						
11 steps		30°	6	48 □ 20A	M10H . x x x - x ¹⁾ - . ST111		
				32A	M20 . x x x - - - . ST111		
				64 □ 32A	N20 . x - x - x x . ST111		
				50A	N33F . x - x - x - . ST111		
				88 □ 63A	N40 . x - x - x - . ST111		
80A	N60 . x - x - x - . ST111						
115A	N80 . x - x - - - . ST111						
132 □ 150A	N100 . x - x - - - . ST111						
250A	N200 . x - x - - - . ST111						
12 steps		30°	6	48 □ 20A	M10H . x x x - x ¹⁾ - . ST121		
				32A	M20 . x x x - - - . ST121		
				64 □ 32A	N20 . x - x - x x . ST121		
				50A	N33F . x - x - x - . ST121		
				88 □ 63A	N40 . x - x - x - . ST121		
80A	N60 . x - x - x - . ST121						
115A	N80 . x - x - - - . ST121						
132 □ 150A	N100 . x - x - - - . ST121						
250A	N200 . x - x - - - . ST121						

Ordering example: AC21 250A panel mounting, multi step switch 1-pole without off, 12 steps **N200 E ST121**

1) Plastic enclosed switches are delivered with switch type M10.

Switching programs

Description	Wiring diagram	Switching angle	Number of cells ↓ Size ↓ AC21	Type	Design see page 6-8 E. Z. V. SMA. P. G.	Switch pro- gram	Escutcheon plate
Multi step switches 1-pole with Off ST0.1							
2 steps		60°	1 48 □ 20A	M10H . x x x x x ¹⁾ - . ST021			
			32A	M20 . x x x x - - . ST021			
			64 □ 32A	N20 . x - x - x x . ST021			
			50A	N33F . x x x - x - . ST021			
			88 □ 63A	N40 . x - x - x - . ST021			
80A	N60 . x - x - x - . ST021						
115A	N80 . x - x - - - . ST021						
132 □ 150A	N100 . x - x - - - . ST021						
250A	N200 . x - x - - - . ST021						
+422							
3 steps		45°	2 48 □ 20A	M10H . x x x x x ¹⁾ - . ST031			
			32A	M20 . x x x x - - . ST031			
			64 □ 32A	N20 . x - x - x x . ST031			
			50A	N33F . x x x - x - . ST031			
			88 □ 63A	N40 . x - x - x - . ST031			
80A	N60 . x - x - x - . ST031						
115A	N80 . x - x - - - . ST031						
132 □ 150A	N100 . x - x - - - . ST031						
250A	N200 . x - x - - - . ST031						
+127							
4 steps		30°	2 48 □ 20A	M10H . x x x x x ¹⁾ - . ST041			
			32A	M20 . x x x x - - . ST041			
			64 □ 32A	N20 . x - x - x x . ST041			
			50A	N33F . x x x - x - . ST041			
			88 □ 63A	N40 . x - x - x - . ST041			
80A	N60 . x - x - x - . ST041						
115A	N80 . x - x - - - . ST041						
132 □ 150A	N100 . x - x - - - . ST041						
250A	N200 . x - x - - - . ST041						
+112							
5 steps		45°	3 48 □ 20A	M10H . x x x x x ¹⁾ - . ST051			
			32A	M20 . x x x x - - . ST051			
			64 □ 32A	N20 . x - x - x x . ST051			
			50A	N33F . x x x - x - . ST051			
			88 □ 63A	N40 . x - x - x - . ST051			
80A	N60 . x - x - x - . ST051						
115A	N80 . x - x - - - . ST051						
132 □ 150A	N100 . x - x - - - . ST051						
250A	N200 . x - x - - - . ST051						
+423							
6 steps		45°	4 48 □ 20A	M10H . x x x x x ¹⁾ - . ST061			
			32A	M20 . x x x x - - . ST061			
			64 □ 32A	N20 . x - x - x x . ST061			
			50A	N33F . x - x - x - . ST061			
			88 □ 63A	N40 . x - x - x - . ST061			
80A	N60 . x - x - x - . ST061						
115A	N80 . x - x - - - . ST061						
132 □ 150A	N100 . x - x - - - . ST061						
250A	N200 . x - x - - - . ST061						
+128							

Ordering example: AC21 250A panel mounting, multi step switch 1-pole with off, 6 steps

N200 E ST061

1) Plastic enclosed switches are delivered with switch type M10.

Switching programs

Description	Wiring diagram	Switching angle	Number of cells ↓ Size ↓ AC21	Type	Design see page 6-8 E. Z. V. SMA. P. G.	Switch pro- gram	Escutcheon plate
Multi step switches 1-pole with Off ST0.1							
7 steps		45°	4	48 □ 20A	M10H . x x x x x ¹⁾ - . ST071		
				32A	M20 . x x x x - - . ST071		
				64 □ 32A	N20 . x - x - - x x . ST071		
				50A	N33F . x - x - - x - . ST071		
				88 □ 63A	N40 . x - x - - x - . ST071		
80A	N60 . x - x - - x - . ST071						
115A	N80 . x - x - - - - . ST071						
132 □ 150A	N100 . x - x - - - - . ST071						
250A	N200 . x - x - - - - . ST071						
8 steps		30°	5	48 □ 20A	M10H . x x x x x ¹⁾ - . ST081		
				32A	M20 . x x x x - - . ST081		
				64 □ 32A	N20 . x - x - - x x . ST081		
				50A	N33F . x - x - - x - . ST081		
				88 □ 63A	N40 . x - x - - x - . ST081		
80A	N60 . x - x - - x - . ST081						
115A	N80 . x - x - - - - . ST081						
132 □ 150A	N100 . x - x - - - - . ST081						
250A	N200 . x - x - - - - . ST081						
9 steps		30°	5	48 □ 20A	M10H . x x x x x ¹⁾ - . ST091		
				32A	M20 . x x x x - - . ST091		
				64 □ 32A	N20 . x - x - - x x . ST091		
				50A	N33F . x - x - - x - . ST091		
				88 □ 63A	N40 . x - x - - x - . ST091		
80A	N60 . x - x - - x - . ST091						
115A	N80 . x - x - - - - . ST091						
132 □ 150A	N100 . x - x - - - - . ST091						
250A	N200 . x - x - - - - . ST091						
10 steps		30°	6	48 □ 20A	M10H . x x x - - x ¹⁾ - . ST0101		
				32A	M20 . x x x - - - - . ST0101		
				64 □ 32A	N20 . x - x - - x x . ST0101		
				50A	N33F . x - x - - x - . ST0101		
				88 □ 63A	N40 . x - x - - x - . ST0101		
80A	N60 . x - x - - x - . ST0101						
115A	N80 . x - x - - - - . ST0101						
132 □ 150A	N100 . x - x - - - - . ST0101						
250A	N200 . x - x - - - - . ST0101						
11 steps		30°	6	48 □ 20A	M10H . x x x - - x ¹⁾ - . ST0111		
				32A	M20 . x x x - - - - . ST0111		
				64 □ 32A	N20 . x - x - - x x . ST0111		
				50A	N33F . x - x - - x - . ST0111		
				88 □ 63A	N40 . x - x - - x - . ST0111		
80A	N60 . x - x - - x - . ST0111						
115A	N80 . x - x - - - - . ST0111						
132 □ 150A	N100 . x - x - - - - . ST0111						
250A	N200 . x - x - - - - . ST0111						

Ordering example: AC21 250A panel mounting, multi step switch 1-pole with off, 11 steps **N200 E ST0111**

1) Plastic enclosed switches are delivered with switch type M10.

Switching programs

Description	Wiring diagram	Switching angle	Number of cells ↓ Size ↓ AC21	Type	Design see page 6-8 E. Z. V. SMA. P. G.	Switch pro- gram	Escutcheon plate
3 steps		60°	3	48 □ 20A 32A	M10H . x x x x x ¹⁾ - M20 . x x x x - -	. ST32 . ST32	
				64 □ 32A 50A	N20 . x - x - x x N33F . x x x - x -	. ST32 . ST32	
				88 □ 63A 80A 115A	N40 . x - x - x - N60 . x - x - x - N80 . x - x - - -	. ST32 . ST32 . ST32	
				132 □ 150A 250A	N100 . x - x - - - N200 . x - x - - -	. ST32 . ST32	
4 steps		60°	4	48 □ 20A 32A	M10H . x x x x x ¹⁾ - M20 . x x x x - -	. ST42 . ST42	
				64 □ 32A 50A	N20 . x - x - x x N33F . x - x - x -	. ST42 . ST42	
				88 □ 63A 80A 115A	N40 . x - x - x - N60 . x - x - x - N80 . x - x - - -	. ST42 . ST42 . ST42	
				132 □ 150A 250A	N100 . x - x - - - N200 . x - x - - -	. ST42 . ST42	
5 steps		60°	5	48 □ 20A 32A	M10H . x x x x x ¹⁾ - M20 . x x x x - -	. ST52 . ST52	
				64 □ 32A 50A	N20 . x - x - x x N33F . x - x - x -	. ST52 . ST52	
				88 □ 63A 80A 115A	N40 . x - x - x - N60 . x - x - x - N80 . x - x - - -	. ST52 . ST52 . ST52	
				132 □ 150A 250A	N100 . x - x - - - N200 . x - x - - -	. ST52 . ST52	
6 steps		60°	6	48 □ 20A 32A	M10H . x x x - x ¹⁾ - M20 . x x x - - -	. ST62 . ST62	
				64 □ 32A 50A	N20 . x - x - x x N33F . x - x - x -	. ST62 . ST62	
				88 □ 63A 80A 115A	N40 . x - x - x - N60 . x - x - x - N80 . x - x - - -	. ST62 . ST62 . ST62	
				132 □ 150A 250A	N100 . x - x - - - N200 . x - x - - -	. ST62 . ST62	
7 steps		45°	7	48 □ 20A 32A	M10H . x x x - - - M20 . x x x - - -	. ST72 . ST72	
				64 □ 32A 50A	N20 . x - x - x - N33F . x - x - - -	. ST72 . ST72	
				88 □ 63A 80A 115A	N40 . x - x - x - N60 . x - x - - - N80 . x - x - - -	. ST72 . ST72 . ST72	
				132 □ 150A 250A	N100 . x - x - - - N200 . x - x - - -	. ST72 . ST72	

Ordering example: AC21 250A panel mounting, multi step switch 2-pole without off, 7 steps **N200 E ST72**

1) Plastic enclosed switches are delivered with switch type M10.

Switching programs

Description	Wiring diagram	Switching angle	Number of cells ↓ Size ↓ AC21	Type	Design see page 6-8 E. Z. V. SMA. P. G.	Switch pro- gram	Escutcheon plate
Multi step switches 2-pole without Off ST.2							
8 steps		45°	8 48 □ 20A	M10H . x x x - - - . ST82 M20 . x x x - - - . ST82			
			64 □ 32A	N20 . x - x - - - . ST82 N33F . x - x - - - . ST82			
			88 □ 63A	N40 . x - x - - - . ST82 N60 . x - x - - - . ST82 N80 . x - x - - - . ST82			
			132 □ 150A	N100 . x - x - - - . ST82 N200 . x - x - - - . ST82			
			250A				
9 steps		30°	9 48 □ 20A	M10H . x x x - - - . ST92 M20 . x x x - - - . ST92			
			64 □ 32A	N20 . x - x - - - . ST92 N33F . x - x - - - . ST92			
			88 □ 63A	N40 . x - x - - - . ST92 N60 . x - x - - - . ST92 N80 . x - x - - - . ST92			
			132 □ 150A	N100 . x - x - - - . ST92 N200 . x - x - - - . ST92			
			250A				
10 steps		30°	10 48 □ 20A	M10H . x x x - - - . ST102 M20 . x x x - - - . ST102			
			64 □ 32A	N20 . x - x - - - . ST102 N33F . x - x - - - . ST102			
			88 □ 63A	N40 . x - x - - - . ST102 N60 . x - x - - - . ST102 N80 . x - x - - - . ST102			
			132 □ 150A	N100 . x - x - - - . ST102 N200 . x - x - - - . ST102			
			250A				
11 steps		30°	11 48 □ 20A	M10H . x x x - - - . ST112 M20 . x x x - - - . ST112			
			64 □ 32A	N20 . x - x - - - . ST112 N33F . x - x - - - . ST112			
			88 □ 63A	N40 . x - x - - - . ST112 N60 . x - x - - - . ST112 N80 . x - x - - - . ST112			
			132 □ 150A	N100 . x - x - - - . ST112 N200 . x - x - - - . ST112			
			250A				
12 steps		30°	12 48 □ 20A	M10H . x x x - - - . ST122 M20 . x x x - - - . ST122			
			64 □ 32A	N20 . x - x - - - . ST122 N33F . x - x - - - . ST122			
			88 □ 63A	N40 . x - x - - - . ST122 N60 . x - x - - - . ST122 N80 . x - x - - - . ST122			
			132 □ 150A	N100 . x - x - - - . ST122 N200 . x - x - - - . ST122			
			250A				

Ordering example: AC21 250A panel mounting, multi step switch 2-pole without off, 12 steps **N200 E ST122**

Switching programs

Description	Wiring diagram	Switching angle	Number of cells ↓ Size ↓ AC21	Type	Design see page 6-8 E. Z. V. SMA. P. G.	Switch pro- gram	Escutcheon plate
Multi step switches 2-pole with Off ST0.2							
2 steps		60°	48 □ 20A	M10H . x x x x x ¹⁾ - . ST022 M20 . x x x x - - . ST022			
			64 □ 32A	N20 . x - x - x x . ST022 N33F . x x x - x - . ST022			
			88 □ 63A	N40 . x - x - x - . ST022 N60 . x - x - x - . ST022 N80 . x - x - - - . ST022			
			132 □ 150A	N100 . x - x - - - . ST022 N200 . x - x - - - . ST022			
			250A				
3 steps		45°	48 □ 20A	M10H . x x x x x ¹⁾ - . ST032 M20 . x x x x - - . ST032			
			64 □ 32A	N20 . x - x - x x . ST032 N33F . x x x - x - . ST032			
			88 □ 63A	N40 . x - x - x - . ST032 N60 . x - x - x - . ST032 N80 . x - x - - - . ST032			
			132 □ 150A	N100 . x - x - - - . ST032 N200 . x - x - - - . ST032			
			250A				
4 steps		30°	48 □ 20A	M10H . x x x x x ¹⁾ - . ST042 M20 . x x x x - - . ST042			
			64 □ 32A	N20 . x - x - x x . ST042 N33F . x - x - x - . ST042			
			88 □ 63A	N40 . x - x - x - . ST042 N60 . x - x - x - . ST042 N80 . x - x - - - . ST042			
			132 □ 150A	N100 . x - x - - - . ST042 N200 . x - x - - - . ST042			
			250A				
5 steps		45°	48 □ 20A	M10H . x x x - x ¹⁾ - . ST052 M20 . x x x - - - . ST052			
			64 □ 32A	N20 . x - x - x x . ST052 N33F . x - x - x - . ST052			
			88 □ 63A	N40 . x - x - x - . ST052 N60 . x - x - x - . ST052 N80 . x - x - - - . ST052			
			132 □ 150A	N100 . x - x - - - . ST052 N200 . x - x - - - . ST052			
			250A				
6 steps		45°	48 □ 20A	M10H . x x x - x ¹⁾ - . ST062 M20 . x x x - - - . ST062			
			64 □ 32A	N20 . x - x - x - . ST062 N33F . x - x - - - . ST062			
			88 □ 63A	N40 . x - x - x - . ST062 N60 . x - x - - - . ST062 N80 . x - x - - - . ST062			
			132 □ 150A	N100 . x - x - - - . ST062 N200 . x - x - - - . ST062			
			250A				

Ordering example: AC21 250A panel mounting, multi step switch 2-pole with off, 6 steps

N200 E ST062

1) Plastic enclosed switches are delivered with switch type M10.

Switching programs

Description	Wiring diagram	Switching angle	Number of cells ↓ Size ↓ AC21	Type	Design see page 6-8 E. Z. V. SMA. P. G.	Switch pro- gram	Escutcheon plate
Multi step switches 2-pole with Off ST0.2							
7 steps		45°	8	48 □ 20A 32A	M10H . x x x - - - . M20 . x x x - - - .	ST072 ST072	
			64 □	32A 50A	N20 . x - x - - - . N33F . x - x - - - .	ST072 ST072	
			88 □	63A 80A 115A	N40 . x - x - - - . N60 . x - x - - - . N80 . x - x - - - .	ST072 ST072 ST072	
			132 □	150A 250A	N100 . x - x - - - . N200 . x - x - - - .	ST072 ST072	
8 steps		30°	9	48 □ 20A 32A	M10H . x x x - - - . M20 . x x x - - - .	ST082 ST082	
			64 □	32A 50A	N20 . x - x - - - . N33F . x - x - - - .	ST082 ST082	
			88 □	63A 80A 115A	N40 . x - x - - - . N60 . x - x - - - . N80 . x - x - - - .	ST082 ST082 ST082	
			132 □	150A 250A	N100 . x - x - - - . N200 . x - x - - - .	ST082 ST082	
9 steps		30°	10	48 □ 20A 32A	M10H . x x x - - - . M20 . x x x - - - .	ST092 ST092	
			64 □	32A 50A	N20 . x - x - - - . N33F . x - x - - - .	ST092 ST092	
			88 □	63A 80A 115A	N40 . x - x - - - . N60 . x - x - - - . N80 . x - x - - - .	ST092 ST092 ST092	
			132 □	150A 250A	N100 . x - x - - - . N200 . x - x - - - .	ST092 ST092	
10 steps		30°	11	48 □ 20A 32A	M10H . x x x - - - . M20 . x x x - - - .	ST0102 ST0102	
			64 □	32A 50A	N20 . x - x - - - . N33F . x - x - - - .	ST0102 ST0102	
			88 □	63A 80A 115A	N40 . x - x - - - . N60 . x - x - - - . N80 . x - x - - - .	ST0102 ST0102 ST0102	
			132 □	150A 250A	N100 . x - x - - - . N200 . x - x - - - .	ST0102 ST0102	
11 steps		30°	12	48 □ 20A 32A	M10H . x x x - - - . M20 . x x x - - - .	ST0112 ST0112	
			64 □	32A 50A	N20 . x - x - - - . N33F . x - x - - - .	ST0112 ST0112	
			88 □	63A 80A 115A	N40 . x - x - - - . N60 . x - x - - - . N80 . x - x - - - .	ST0112 ST0112 ST0112	
			132 □	150A 250A	N100 . x - x - - - . N200 . x - x - - - .	ST0112 ST0112	

Ordering example: AC21 250A panel mounting, multi step switch 2-pole with off, 11 steps **N200 E ST0112**

Switching programs

Description	Wiring diagram	Switching angle	Number of cells ↓ Size ↓ AC21	Type	Design see page 6-8 E. Z. V. SMA. P. G.	Switch pro- gram	Escutcheon plate
3 steps		60°	5	48 □ 20A 32A	M10H . x x x x x ¹⁾ - M20 . x x x x - -	. ST33 . ST33	
				64 □ 32A 50A	N20 . x - x - x x N33F . x - x - x -	. ST33 . ST33	
				88 □ 63A 80A 115A	N40 . x - x - x - N60 . x - x - x - N80 . x - x - - -	. ST33 . ST33 . ST33	
				132 □ 150A 250A	N100 . x - x - - - N200 . x - x - - -	. ST33 . ST33	
4 steps		60°	6	48 □ 20A 32A	M10H . x x x - x ¹⁾ - M20 . x x x - - -	. ST43 . ST43	
				64 □ 32A 50A	N20 . x - x - x x N33F . x - x - x -	. ST43 . ST43	
				88 □ 63A 80A 115A	N40 . x - x - x - N60 . x - x - x - N80 . x - x - - -	. ST43 . ST43 . ST43	
				132 □ 150A 250A	N100 . x - x - - - N200 . x - x - - -	. ST43 . ST43	
5 steps		60°	8	48 □ 20A 32A	M10H . x x x - - - M20 . x x x - - -	. ST53 . ST53	
				64 □ 32A 50A	N20 . x - x - x - N33F . x - x - - -	. ST53 . ST53	
				88 □ 63A 80A 115A	N40 . x - x - x - N60 . x - x - - - N80 . x - x - - -	. ST53 . ST53 . ST53	
				132 □ 150A 250A	N100 . x - x - - - N200 . x - x - - -	. ST53 . ST53	
6 steps		60°	9	48 □ 20A 32A	M10H . x x x - - - M20 . x x x - - -	. ST63 . ST63	
				64 □ 32A 50A	N20 . x - x - - - N33F . x - x - - -	. ST63 . ST63	
				88 □ 63A 80A 115A	N40 . x - x - - - N60 . x - x - - - N80 . x - x - - -	. ST63 . ST63 . ST63	
				132 □ 150A 250A	N100 . x - x - - - N200 . x - x - - -	. ST63 . ST63	
7 steps		45°	11	48 □ 20A 32A	M10H . x x x - - - M20 . x x x - - -	. ST73 . ST73	
				64 □ 32A 50A	N20 . x - x - - - N33F . x - x - - -	. ST73 . ST73	
				88 □ 63A 80A 115A	N40 . x - x - - - N60 . x - x - - - N80 . x - x - - -	. ST73 . ST73 . ST73	
				132 □ 150A 250A	N100 . x - x - - - N200 . x - x - - -	. ST73 . ST73	

Ordering example: AC21 250A panel mounting, multi step switch 3-pole without off, 7 steps **N200 E ST73**

1) Plastic enclosed switches are delivered with switch type M10.

Switching programs

Description	Wiring diagram	Switching angle	Number of cells ↓ Size ↓ AC21	Type	Design see page 6-8 E. Z. V. SMA. P. G.	Switch pro- gram	Escutcheon plate
Multi step switches 3-pole without Off ST.3							
8 steps		45°	12 48 □ 20A	M10H . x x x - - - . ST83 M20 . x x x - - - . ST83			
			64 □ 32A	N20 . x - x - - - . ST83 N33F . x - x - - - . ST83			
			88 □ 63A	N40 . x - x - - - . ST83 N60 . x - x - - - . ST83 N80 . x - x - - - . ST83			
			132 □ 150A	N100 . x - x - - - . ST83 N200 . x - x - - - . ST83			
			250A				
9 steps		30°	14 48 □ 20A	M10H . x - x - - - . ST93 M20 . x - x - - - . ST93			
			64 □ 32A	N20 . x - x - - - . ST93 N33F . x - x - - - . ST93			
			88 □ 63A	N40 . x - x - - - . ST93 N60 . x - x - - - . ST93 N80 . x - x - - - . ST93			
			132 □ 150A	N100 . x - x - - - . ST93 N200 . x - x - - - . ST93			
			250A				
10 steps		30°	15 48 □ 20A	M10H . x - x - - - . ST103 M20 . x - x - - - . ST103			
			64 □ 32A	N20 . x - x - - - . ST103 N33F . x - x - - - . ST103			
			88 □ 63A	N40 . x - x - - - . ST103 N60 . x - x - - - . ST103 N80 . x - x - - - . ST103			
			132 □ 150A	N100 . x - x - - - . ST103 N200 . x - x - - - . ST103			
			250A				
11 steps		30°	17 48 □ 20A	M10H . x - x - - - . ST113 M20 . x - x - - - . ST113			
			64 □ 32A	N20 . x - x - - - . ST113 N33F . x - x - - - . ST113			
			88 □ 63A	N40 . x - x - - - . ST113 N60 . x - x - - - . ST113 N80 . x - x - - - . ST113			
			132 □ 150A	N100 . x - x - - - . ST113 N200 . x - x - - - . ST113			
			250A				
12 steps		30°	18 48 □ 20A	M10H . x - x - - - . ST123 M20 . x - x - - - . ST123			
			64 □ 32A	N20 . x - x - - - . ST123 N33F . x - x - - - . ST123			
			88 □ 63A	N40 . x - x - - - . ST123 N60 . x - x - - - . ST123 N80 . x - x - - - . ST123			
			132 □ 150A	N100 . x - x - - - . ST123 N200 . x - x - - - . ST123			
			250A				

Ordering example: AC21 250A panel mounting, multi step switch 3-pole without off, 12 steps **N200 E ST123**

Switching programs

Description	Wiring diagram	Switching angle	Number of cells ↓ Size ↓ AC21	Type	Design see page 6-8 E. Z. V. SMA. P. G.	Switch pro- gram	Escutcheon plate	
Multi step switches 3-pole with Off ST0.3								
2 steps		60°	3	48 □ 20A	M10H . x x x x x ¹⁾ - . ST023	. ST023		
				32A	M20 . x x x x - - . ST023			
				64 □ 32A	N20 . x - x - x x . ST023			+422
				50A	N33F . x x x - x - . ST023			
				88 □ 63A	N40 . x - x - x - . ST023			
80A	N60 . x - x - x - . ST023							
115A	N80 . x - x - - - . ST023							
132 □ 150A	N100 . x - x - - - . ST023	. ST023						
250A	N200 . x - x - - - . ST023							
3 steps		45°	5	48 □ 20A	M10H . x x x x x ¹⁾ - . ST033	. ST033		
				32A	M20 . x x x x - - . ST033			
				64 □ 32A	N20 . x - x - x x . ST033			+127
				50A	N33F . x - x - x - . ST033			
				88 □ 63A	N40 . x - x - x - . ST033			
80A	N60 . x - x - x - . ST033							
115A	N80 . x - x - - - . ST033							
132 □ 150A	N100 . x - x - - - . ST033	. ST033						
250A	N200 . x - x - - - . ST033							
4 steps		30°	6	48 □ 20A	M10H . x x x - x ¹⁾ - . ST043	. ST043		
				32A	M20 . x x x - - - . ST043			
				64 □ 32A	N20 . x - x - x x . ST043			+112
				50A	N33F . x - x - x - . ST043			
				88 □ 63A	N40 . x - x - x - . ST043			
80A	N60 . x - x - x - . ST043							
115A	N80 . x - x - - - . ST043							
132 □ 150A	N100 . x - x - - - . ST043	. ST043						
250A	N200 . x - x - - - . ST043							
5 steps		45°	9	48 □ 20A	M10H . x x x - - - . ST053	. ST053		
				32A	M20 . x x x - - - . ST053			
				64 □ 32A	N20 . x - x - - - . ST053			+423
				50A	N33F . x - x - - - . ST053			
				88 □ 63A	N40 . x - x - - - . ST053			
80A	N60 . x - x - - - . ST053							
115A	N80 . x - x - - - . ST053							
132 □ 150A	N100 . x - x - - - . ST053	. ST053						
250A	N200 . x - x - - - . ST053							
6 steps		45°	11	48 □ 20A	M10H . x x x - - - . ST063	. ST063		
				32A	M20 . x x x - - - . ST063			
				64 □ 32A	N20 . x - x - - - . ST063			+128
				50A	N33F . x - x - - - . ST063			
				88 □ 63A	N40 . x - x - - - . ST063			
80A	N60 . x - x - - - . ST063							
115A	N80 . x - x - - - . ST063							
132 □ 150A	N100 . x - x - - - . ST063	. ST063						
250A	N200 . x - x - - - . ST063							

Ordering example: AC21 250A panel mounting, multi step switch 3-pole with off, 6 steps **N200 E ST063**

1) Plastic enclosed switches are delivered with switch type M10.

Switching programs

Description	Wiring diagram	Switching angle	Number of cells ↓ Size ↓ AC21	Type	Design see page 6-8 E. Z. V. SMA. P. G.	Switch pro- gram	Escutcheon plate
Multi step switches 3-pole with Off ST0.3							
7 steps		45°	12 48 □ 20A	M10H . x x x - - - . ST073 M20 . x x x - - - . ST073		. ST073 . ST073	+129
			64 □ 32A 50A	N20 . x - x - - - . ST073 N33F . x - x - - - . ST073			
			88 □ 63A 80A 115A	N40 . x - x - - - . ST073 N60 . x - x - - - . ST073 N80 . x - x - - - . ST073			
			132 □ 150A 250A	N100 . x - x - - - . ST073 N200 . x - x - - - . ST073			
8 steps		30°	14 48 □ 20A	M10H . x - x - - - . ST083 M20 . x - x - - - . ST083		. ST083 . ST083	+114
			64 □ 32A 50A	N20 . x - x - - - . ST083 N33F . x - x - - - . ST083			
			88 □ 63A 80A 115A	N40 . x - x - - - . ST083 N60 . x - x - - - . ST083 N80 . x - x - - - . ST083			
			132 □ 150A 250A	N100 . x - x - - - . ST083 N200 . x - x - - - . ST083			
9 steps		30°	15 48 □ 20A	M10H . x - x - - - . ST093 M20 . x - x - - - . ST093		. ST093 . ST093	+115
			64 □ 32A 50A	N20 . x - x - - - . ST093 N33F . x - x - - - . ST093			
			88 □ 63A 80A 115A	N40 . x - x - - - . ST093 N60 . x - x - - - . ST093 N80 . x - x - - - . ST093			
			132 □ 150A 250A	N100 . x - x - - - . ST093 N200 . x - x - - - . ST093			
10 steps		30°	17 48 □ 20A	M10H . x - x - - - . ST0103 M20 . x - x - - - . ST0103		. ST0103 . ST0103	+116
			64 □ 32A 50A	N20 . x - x - - - . ST0103 N33F . x - x - - - . ST0103			
			88 □ 63A 80A 115A	N40 . x - x - - - . ST0103 N60 . x - x - - - . ST0103 N80 . x - x - - - . ST0103			
			132 □ 150A 250A	N100 . x - x - - - . ST0103 N200 . x - x - - - . ST0103			
11 steps		30°	18 48 □ 20A	M10H . x - x - - - . ST0113 M20 . x - x - - - . ST0113		. ST0113 . ST0113	+117
			64 □ 32A 50A	N20 . x - x - - - . ST0113 N33F . x - x - - - . ST0113			
			88 □ 63A 80A 115A	N40 . x - x - - - . ST0113 N60 . x - x - - - . ST0113 N80 . x - x - - - . ST0113			
			132 □ 150A 250A	N100 . x - x - - - . ST0113 N200 . x - x - - - . ST0113			

Ordering example: AC21 250A panel mounting, multi step switch 3-pole with off, 11 steps **N200 E ST0113**

Mini-Cam Switches M4H

Panel mounting E, IP40



Central fixing Z

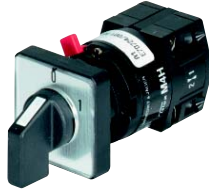

Central fixing without escutcheon plate ZO

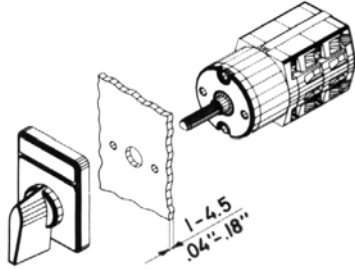

Mounting holes

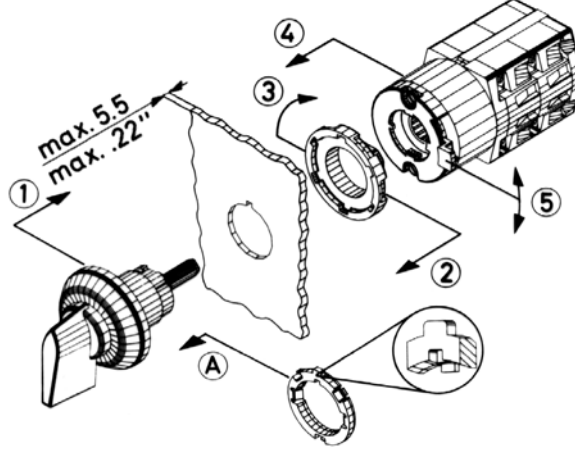
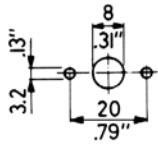

Central fixing 16mm

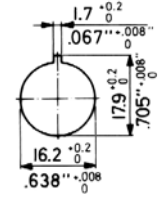

Central fixing 22mm

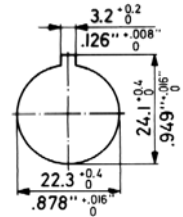

Single hole mountings are generally delivered for a 16mm (.64") mounting. Using the forwarded adapter ring, it is possible to alter the single hole mountings from 22mm (.88"). For that purpose the adapter ring has to be attached onto the threaded part of the body in such a manner, that
 1. the flat side of the adapter ring shows towards the front seal and
 2. the inner nose fits into the notch of the body.
 The adapter ring has to be pushed towards the front seal.

Optional extras	ordering code	for design	M4H Z ... +SRE	M4H Z ... +SA.	M4H ZO ... +SA.	M4H Z ... +SRE+SA.
Additional escutcheon plate	+SRE	E, Z, ZO				
Additional escutcheon plate	+SRE2	E, Z, ZO				
Key operated switch with lock KABA	+SA1	Z, ZO				
with lock Ronis	+SA2	Z, ZO				

Wrench J7400
for switches M4H with central fixing is necessary

Panel mounting E

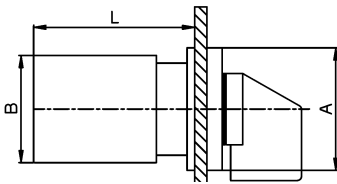

Central fixing Z, ZO

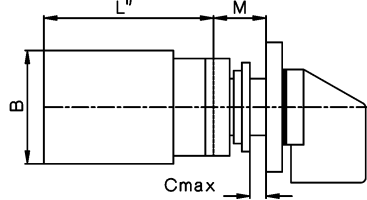

ZO

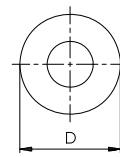

Z

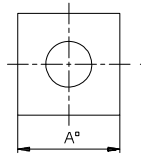

Type	A	B	D	M	Dimension L for ... cells								
					1	2	3	4	5	6	7	8	
M4H	mm	30	28	29,5	12,5	38,5	50,5	62,5	74,5	86,5	98,5	110,5	122,5

Technical data

Type	according to specifications	AC21A	AC15		Volt	Motor rating AC3							
			General use	110V 380V		240V 440V	3 phase 3-pole			1 phase 2-pole			
M4H	IEC, VDE, BS, SEV UL, CSA	10A/500V 10A/300V	2,5A	1,5A	A300	kW	0,65	1,5	2,2	0,3	0,55	-	0,75
						HP	0,75	1	-	0,33	0,75	0,75	-

Type	according to specifications	Volt	Motor rating AC23			2-pole		
			3-pole	110	220	380	110	220
M4H	IEC, VDE, BS, SEV UL, CSA	kW	0,75	1,8	3	0,37	0,75	1,1
		HP	-	-	-	-	-	-

additional data for wiring according to UL and CSA

Type	type of wire	temp. rating of wire	torque value for field wiring terminals
M4H	copper wire only	60/75°C	0,6Nm / 5lb - inch

Mini-Cam Switches M4H

Switch programs

Description	Wiring diagram	AC21 500V 10A AC15 230V 2,5A AC3 4x400V 2,2kW	escutch. 30 x 30	numb. of cells	Type	Design			Switch pro- gram
						.E. ↓	.Z. ↓	.ZO. ↓	
On-Off-switch A									
1-pole				1	M4H .	x	x	x	. A1
2-pole				1	M4H .	x	x	x	. A2
3-pole				2	M4H .	x	x	x	. A3
4-pole				2	M4H .	x	x	x	. A4
6-pole				3	M4H .	x	x	x	. A6
Changeover switch U									
1-pole				1	M4H .	x	x	x	. U1
2-pole				2	M4H .	x	x	x	. U2
3-pole				3	M4H .	x	x	x	. U3
4-pole				4	M4H .	x	x	x	. U4
Changeover switch without off W									
1-pole				1	M4H .	x	x	x	. W1
2-pole				2	M4H .	x	x	x	. W2
3-pole				3	M4H .	x	x	x	. W3
4-pole				4	M4H .	x	x	x	. W4
6-pole				6	M4H .	x	x	x	. W6
Reversing switch WU									
2-pole				2	M4H .	x	x	x	. WU2
3-pole				3	M4H .	x	x	x	. WU3
3-pole with spring return to 0				3	M4H .	x	x	x	. WU3R2
Star-delta switch SD									
1 rotary direction				4	M4H .	x	x	x	. SD
both rotary directions				5	M4H .	x	x	x	. SDR
Changeover with spring return UR									
1-pole				1	M4H .	x	x	x	. UR1
2-pole				2	M4H .	x	x	x	. UR2
3-pole				3	M4H .	x	x	x	. UR3
Start switch									
1-pole				1	M4H .	x	x	x	. SE
Stop switch									
1-pole				1	M4H .	x	x	x	. SA

Ordering example: Stop switch, 1-pole, Central fixing: **M4H Z SA**

Mini-Cam Switches M4H

Switch programs

Description	Wiring diagram	AC21 500V 10A AC15 230V 2,5A AC3 4x400V 2,2kW	escutch. 30 x 30	numb. of cells	Type	Design			Switch pro- gram
						.E. ↓	.Z. ↓	.ZO. ↓	
Start-Stop switch				1	M4H .	x	x	x	. SEA
Start-Stop switch position START with spring return to 1				1	M4H .	x	x	x	. S392
Start-Stop switch for reversing contactors				2	M4H .	x	x	x	. S2EA
Voltmeter selector switch V 3 line voltages				2	M4H .	x	x	x	. V3
3 phase voltages				2	M4H .	x	x	x	. V0
3 line voltages 3 phase voltages				3	M4H .	x	x	x	. V1
Ammeter selector switch A 1-pole, 3 current transformer				4	M4H .	x	x	x	. M31
Gang switch GR 2 circuits A and B 1-pole 0 - A - A+B				1	M4H .	x	x	x	. GR11
2 circuits A and B 1-pole 0 - A - B - A+B				1	M4H .	x	x	x	. GR12
3 circuits A, B and C 1-pole				2	M4H .	x	x	x	. GR14
Multi step switch without 0 ST 3 steps, 1-pole				2	M4H .	x	x	x	. ST31
3 steps, 2-pole				3	M4H .	x	x	x	. ST32
3 steps, 3-pole				5	M4H .	x	x	x	. ST33

Ordering example: Multi step switch without 0, 3 steps, 3-pole, panel mounting: **M4H E ST33**

Mini-Cam Switches M4H

Switch programs

Description	Wiring diagram	AC21 500V 10A AC15 230V 2,5A AC3 4x400V 2,2kW	escutch. 30 x 30	numb. of cells	Type	Design			Switch pro- gram
						.E. ↓	.Z. ↓	.ZO. ↓	
Multi step switch without 0 ST									
4 steps, 1-pole				2	M4H .	x	x	x	. ST41
4 steps, 2-pole				4	M4H .	x	x	x	. ST42
4 steps, 3-pole				6	M4H .	x	x	x	. ST43
5 steps, 1-pole				3	M4H .	x	x	x	. ST51
5 steps, 2-pole				5	M4H .	x	x	x	. ST52
6 steps, 1-pole				3	M4H .	x	x	x	. ST61
6 steps, 2-pole				6	M4H .	x	x	x	. ST62
Multi step switch with 0 ST0.									
2 steps, 1-pole				1	M4H .	x	x	x	. ST021
2 steps, 2-pole				2	M4H .	x	x	x	. ST022
2 steps, 3-pole				3	M4H .	x	x	x	. ST023
3 steps, 1-pole				2	M4H .	x	x	x	. ST031
3 steps, 2-pole				3	M4H .	x	x	x	. ST032
3 steps, 3-pole				5	M4H .	x	x	x	. ST033
4 steps, 1-pole				2	M4H .	x	x	x	. ST041
4 steps, 2-pole				4	M4H .	x	x	x	. ST042
4 steps, 3-pole				6	M4H .	x	x	x	. ST043
5 steps, 1-pole				3	M4H .	x	x	x	. ST051
5 steps, 2-pole				5	M4H .	x	x	x	. ST052
6 steps, 1-pole				4	M4H .	x	x	x	. ST061
7 steps, 1-pole				4	M4H .	x	x	x	. ST071
8 steps, 1-pole				5	M4H .	x	x	x	. ST081
9 steps, 1-pole				5	M4H .	x	x	x	. ST091
10 steps, 1-pole				6	M4H .	x	x	x	. ST0101

Ordering example: Multi step switch with 0, 10 steps, 1-pole, Central fixing without escutcheon plate: **M4H ZO ST0101**

Load Switches for resistive or slightly inductive loads or switching without load

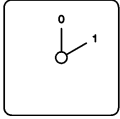
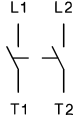
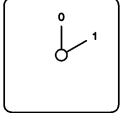
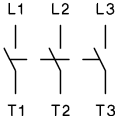
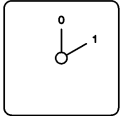
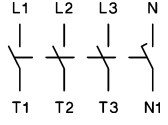
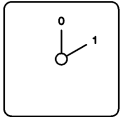
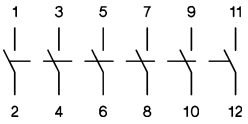
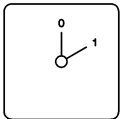
Description	Wiring diagram	Switching angle	Number of cells ↓ Size ↓ AC21	Type	Design		Switch program	Escutcheon plate				
					.E.	.V.						
On-Off-switches A												
1-pole		60°	2 88 □ 125A	L100	x	x	. A1					
			1 180A						L160	x	x	. A1
			1 132 □ 400A	L400	x	x	. A1					
			3 600A						L600	x	x	. A1
			2 800A									
3 1200A	L1200	x	x	. A1								
2-pole						60°	2 88 □ 125A	L100	x	x	. A2	
	2 180A	L160	x	x			. A2					
	2 132 □ 400A							L400	x	x	. A2	
	3 600A	L600	x	x			. A2					
	4 800A											
	6 1200A	L1200	x	x			. A2					
3-pole					60°	4 88 □ 125A		L100	x	x	. A3	
		3 180A	L160	x		x	. A3					
		3 132 □ 400A						L400	x	x	. A3	
		6 600A	L600	x		x	. A3					
		6 800A										
		9 1200A	L1200	x		x	. A3					
4-pole 4. pole early make		60°			4 88 □ 125A			L100	x	x	. A4	
			4 180A	L160	x	x	. A4					
			4 132 □ 400A					L400	x	x	. A4	
			6 600A	L600	x	x	. A4					
			8 800A									
			12 1200A	L1200	x	x	. A4					
6-pole		60°	6 88 □ 125A					L100	x	x	. A6	
			6 180A	L160	x	x	. A6					
			6 132 □ 400A					L400	x	x	. A6	
			9 600A	L600	x	x	. A6					
			12 800A									
			18 1200A	L1200	x	x	. A6					

For switches with the design V.. it is necessary to state the installation depth - that is, the distance between mounting level of the switch and the inside edge of the door (dimension T).

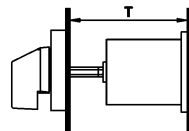

Further informations page
 Technical Data 255
 Dimensions 260

Load Switches for resistive or slightly inductive loads or switching without load

Description	Wiring diagram	Switching angle	Number of cells ↓ Size ↓ AC21	Type	Design		Switch program	Escutcheon plate
					.E.	.V.		
Changeover switches U								
1-pole		60°	2 88 □ 125A	L100 .	x	x	. U1	
			2 180A	L160 .	x	x	. U1	
			2 132 □ 400A	L400 .	x	x	. U1	
			3 600A	L600 .	x	x	. U1	
			4 800A	L800 .	x	x	. U1	
6 1200A	L1200 .	x	x	. U1				
2-pole		60°	4 88 □ 125A	L100 .	x	x	. U2	
			4 180A	L160 .	x	x	. U2	
			4 132 □ 400A	L400 .	x	x	. U2	
			6 600A	L600 .	x	x	. U2	
			8 800A	L800 .	x	x	. U2	
12 1200A	L1200 .	x	x	. U2				
3-pole		60°	6 88 □ 125A	L100 .	x	x	. U3	
			6 180A	L160 .	x	x	. U3	
			6 132 □ 400A	L400 .	x	x	. U3	
			9 600A	L600 .	x	x	. U3	
			12 800A	L800 .	x	x	. U3	
18 1200A	L1200 .	x	x	. U3				
4-pole 4. pole early make		60°	8 88 □ 125A	L100 .	x	x	. U4	
			8 180A	L160 .	x	x	. U4	
			8 132 □ 400A	L400 .	x	x	. U4	
			12 600A	L600 .	x	x	. U4	
			16 800A	L800 .	x	x	. U4	
24 1200A	L1200 .	x	x	. U4				
Changeover switches without off W								
1-pole		60°	2 88 □ 125A	L100 .	x	x	. W1	
			2 180A	L160 .	x	x	. W1	
			2 132 □ 400A	L400 .	x	x	. W1	
			3 600A	L600 .	x	x	. W1	
			4 800A	L800 .	x	x	. W1	
6 1200A	L1200 .	x	x	. W1				
2-pole		60°	4 88 □ 125A	L100 .	x	x	. W2	
			4 180A	L160 .	x	x	. W2	
			4 132 □ 400A	L400 .	x	x	. W2	
			6 600A	L600 .	x	x	. W2	
			8 800A	L800 .	x	x	. W2	
12 1200A	L1200 .	x	x	. W2				
3-pole		60°	6 88 □ 125A	L100 .	x	x	. W3	
			6 180A	L160 .	x	x	. W3	
			6 132 □ 400A	L400 .	x	x	. W3	
			9 600A	L600 .	x	x	. W3	
			12 800A	L800 .	x	x	. W3	
18 1200A	L1200 .	x	x	. W3				
4-pole 4. pole early make		60°	8 88 □ 125A	L100 .	x	x	. W4	
			8 180A	L160 .	x	x	. W4	
			8 132 □ 400A	L400 .	x	x	. W4	
			12 600A	L600 .	x	x	. W4	
			16 800A	L800 .	x	x	. W4	
24 1200A	L1200 .	x	x	. W4				

Ordering example: AC1 1200A panel mounting, changeover switch without off 4-pole L1200 E W4

Operating Knobs and Handles

Types of handles

In the standard version, the switches are supplied with a black twist knob or instrument knob (M10H - N33F), except for design SMA, which has a grey toggle knob. Switches of size L, which consist of 2 or 3 switch columns, come with a black hand wheel. If required, the switch can be supplied with other knobs, which can later easily be exchanged. All operating knobs have an insert, which sets the position of the knob in relation to the switch shaft. This insert can be mounted in 8 different positions (at intervals of 45°), causing the angle of each individual switch setting to be rotated by 45°.

In the standard version, the switch terminals are positioned left and right (except M10H). When the knob insert is turned by 90°, the lay-out of the terminals changes to top and bottom.

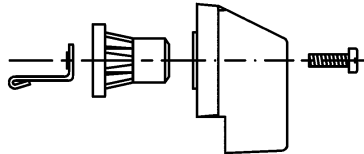

All operating knobs can be moved on the hexagonal shaft, to permit adaptation to different sheet thicknesses, etc.

Type	M10 M10H M20	N20 N33F	N40 N60 N80 L100 L160	N100 N200 L400 L600 L800 L1200
Knob movement mm	5	5	7	9
Hexagonal shaft dimension mm	5	7	9	12

Ordering example: Cam switch N60 V U3 with Instrument knob red
Order type: **N60 V U3 +G3**
Dimensions see page 261

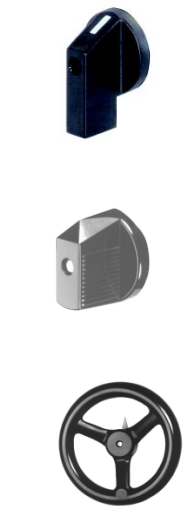

Knobs and handles Description	Colour	Ordering Code	M10 M10H M20	N20 N33F	N40 N60 N80 L100 L160	N100 N200 L400 L600 L800 L1200
Instrument knob Standard for M10 to N200	grey black red white	+G1 +G2 +G3 +G5	X X X X	X X X X	X	X
Toggle knob	grey black red white blue	+K1 +K2 +K3 +K5 +K6	X X X X X	X X X X		
Hand wheel	black	+HR				X

Escutcheon Plates

TELUX-Cam Switches in designs E, V, P, PF, SM, UP, Z and KE are supplied with a square escutcheon plate consisting of a black frame and plexi insert plate. The markings are printed in black on the back of the insert plate. To protect the markings so that they remain easy to read, the back of the insert plate is lined with silver foil. In addition, rectangular plates can be provided for all switch sizes, which can be fitted on all switches after mounting.

Square plate



Rectangular plate (with square plate)

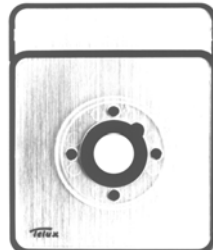

TELUX-Cam Switches in design SMA, for distribution boards with 45mm inside edge of installation cover, is supplied with a grey cover and black markings.



Special engraved markings on escutcheon plates are limited by the available space. In the case of relatively large production runs or frequent use of the text, we recommend ordering of a printing block. This will be invoiced at cost price, and the engraving will not be charged for. This investment generally pays with batches from 50 pieces upwards.

The "escutcheon plate" column of the selection and ordering tables for switch programs indicates the standard plate and, in some cases, an additional plate that is often used for the programs in question. If such a plate, listed in the selection table, is desired, the appropriate code number should be stated when ordering a switch and switch program.

Should only **plates** or **parts** of the latter be ordered, the order type is assembled as shown by the following example.

Code letter of switch sizes

M10, M10H, M20	A
N20, N33F	E
N40, N60, N80, L100, L160	H
N100, N200, L400, L600, L800, L1200	L

Ordering example: Escutcheon plate silver, complete, for cam switch M10, marked with MAN OFF AUTO, angle of rotation 60°

Order type:

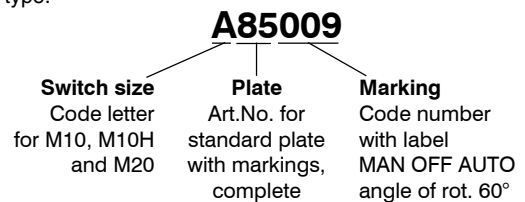

However, if a **switch** with non-standard lettering is required, only three-digit code number for the marking need be added to the order type (see next page).

Dimensions see page 261

Description	Order type Switch size Code letter	Plate Art.No.	Marking Code number
Escutcheon plate for designs E, V, P., Z, SM, KE and UP Escutcheon frame black, plexi insert plate silver, markings black			
Plexi insert plate silver	A E H L	.85...	... (see pp. 238-240)
Plexi insert plate yellow	A E H L	.80...	... (see pp. 238-240)
Escutcheon frame black	A E H L	.8203	-
Rectangular escutcheon plate for designs E, V, Z and SM Escutcheon frame black, plexi insert plate silver, markings black			
Plexi insert plate silver	A E H L	.885..	... (see pp. 238-240)
Plexi insert plate yellow	A E H L	.895..	... (see pp. 238-240)
Escutcheon frame black	A E H L	.8503	-
Installation cover for design SMA grey cover, markings black	A - - -	.68...	... (see page 240)

Escutcheon Plates

Selected standard markings

The markings that are most commonly required are shown below, together with code letters for the switch size and the code number.

Ordering example: Switch type M10H E A3 with escutcheon plate "OFF ON" and additional rectangular escutcheon plate "PUMP"
Order type: **M10H E A3 +003 +516**

Code letter of switch sizes

M10, M10H, M20
N20, N33F
N40, N60, N80, L100, L160
N100, N200, L400, L600, L800, L1200

A
E
H
L

Blank escutcheon plates

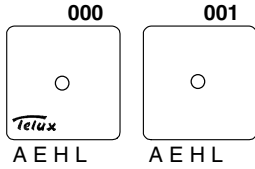

Switching angle 30°

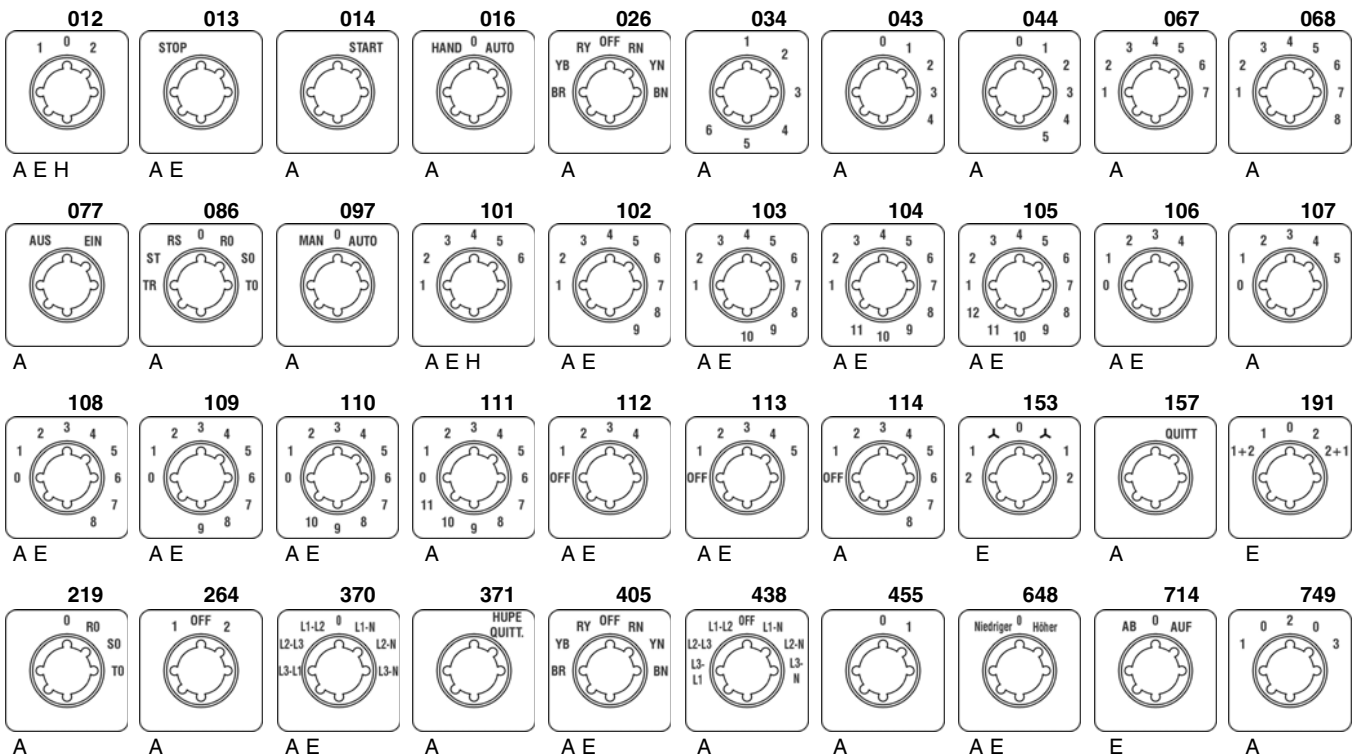

Switching angle 45°

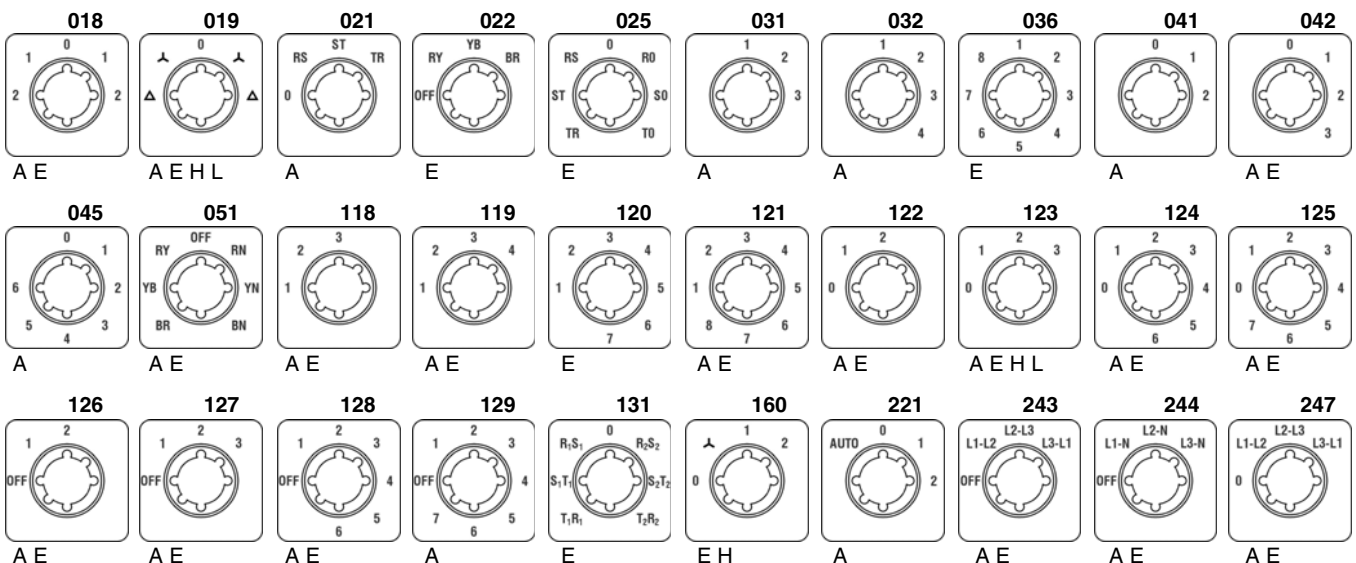

Escutcheon Plates

Switching angle 45°

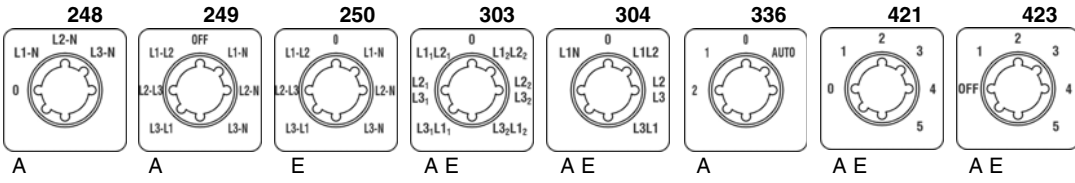

Switching angle 60°

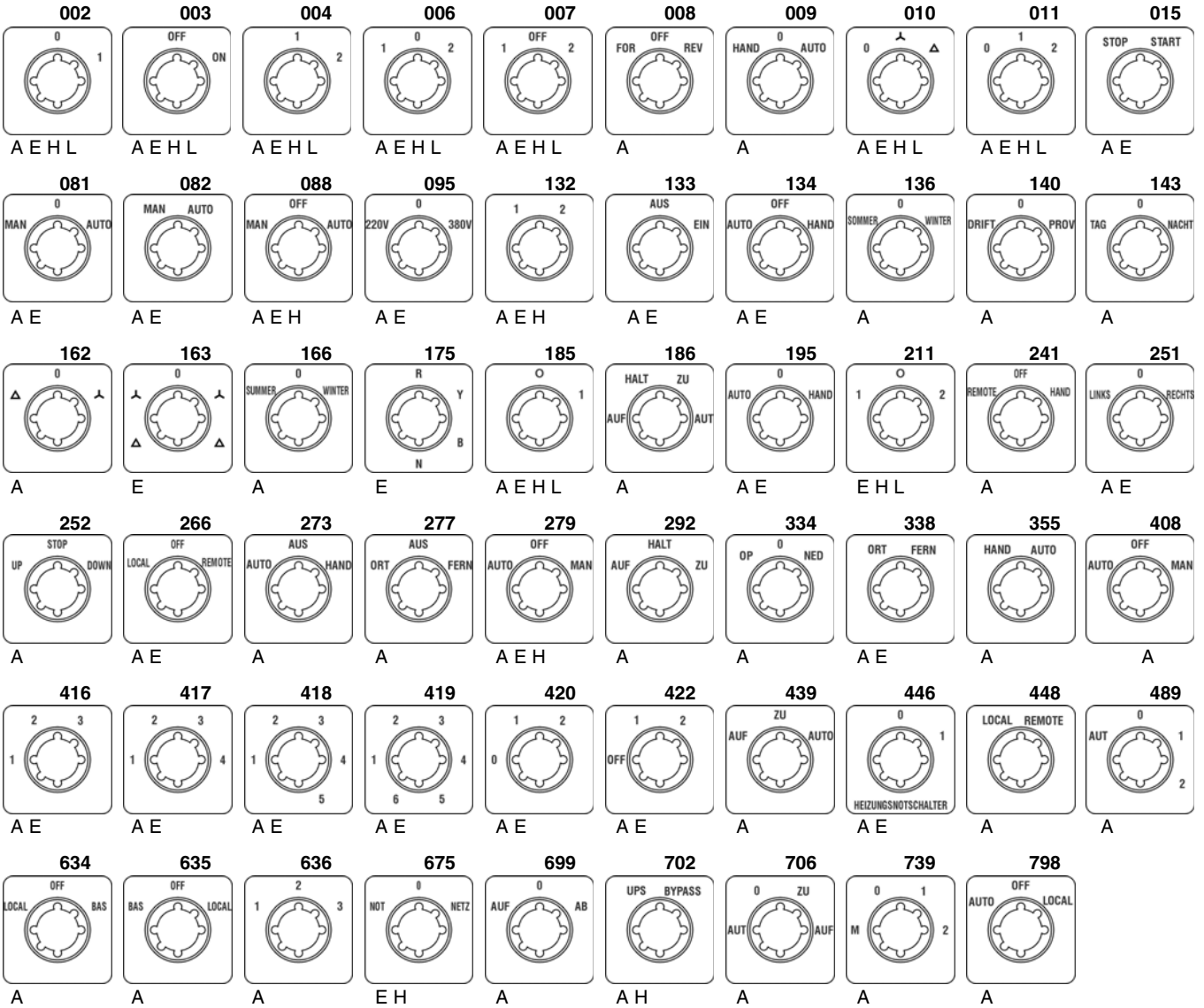

Escutcheon Plates

Switching angle 90°

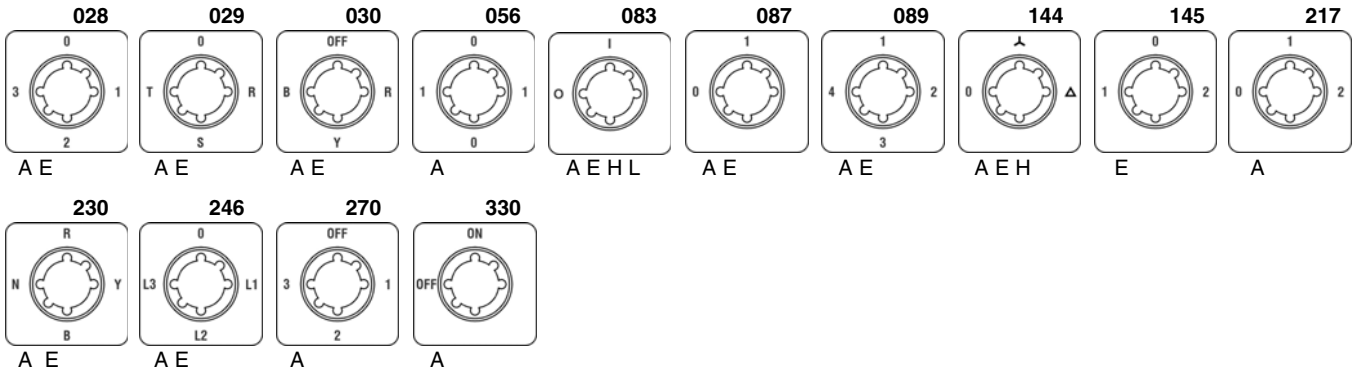

Miscellaneous

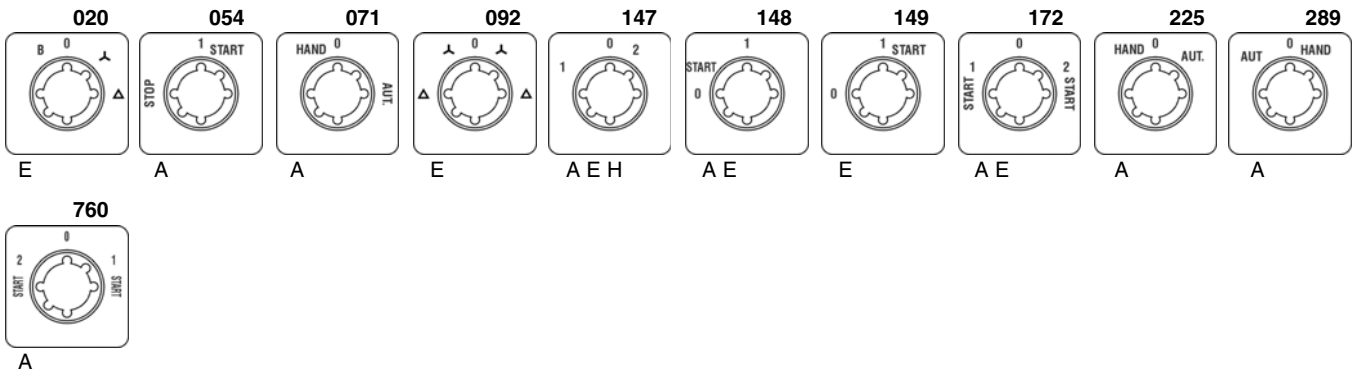

Rectangular additional escutcheon plates

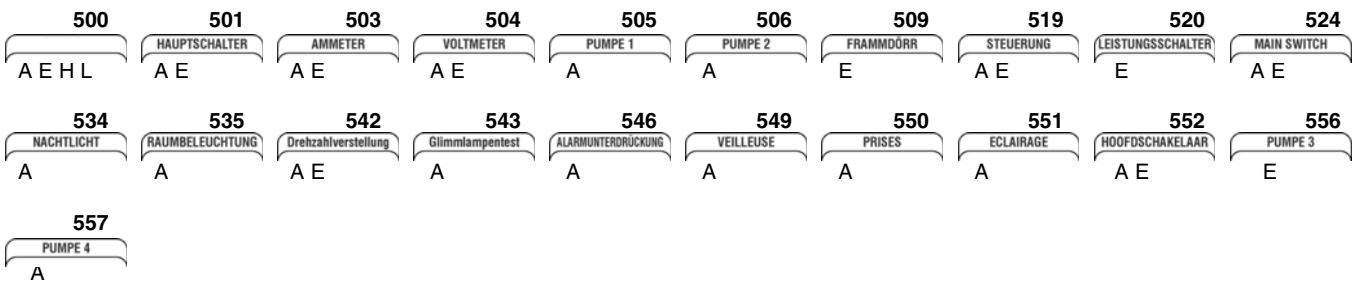

Covers for design SMA

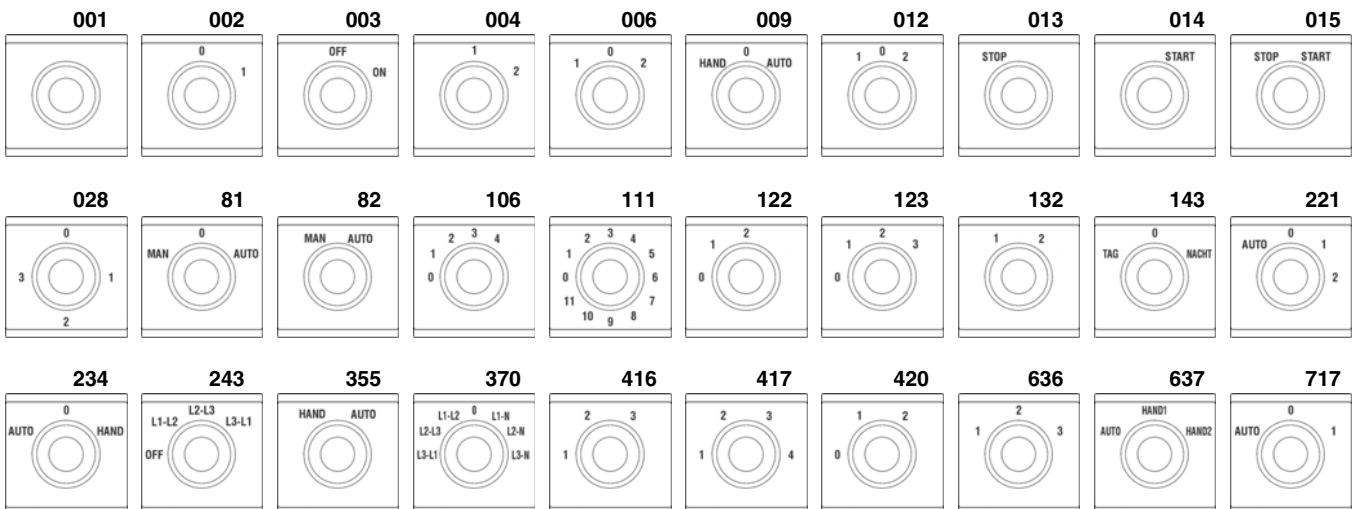

Switching angles

Arrangement of switch settings

All feasible arrangements of switch settings are shown, and defined by position numbers, in the following tables. Not only the switching angles, but also switches with latched or momentary settings, or combinations of the two, are distinguished from one another.

Knowledge of the following variations is particularly important when planning special switches. It is necessary to state the position number when ordering special switches, as the cheapest version will otherwise be selected.

All the switches types listed can be supplied with switching angles other than those indicated, provided that they are permitted by the switch program (additional charge).

Switching angle 30°

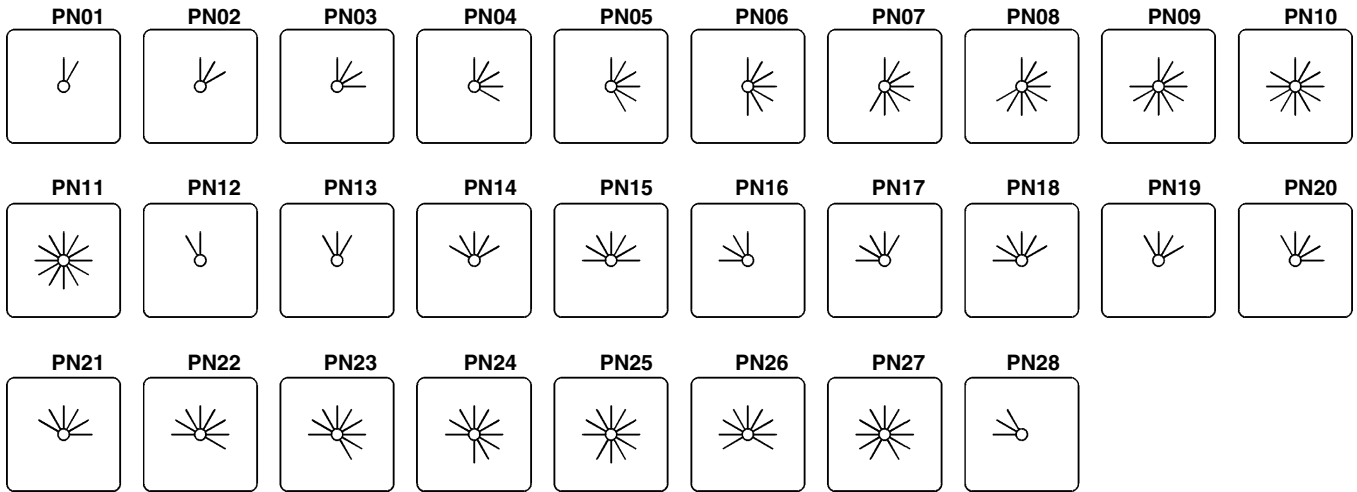

Switching angle 45°

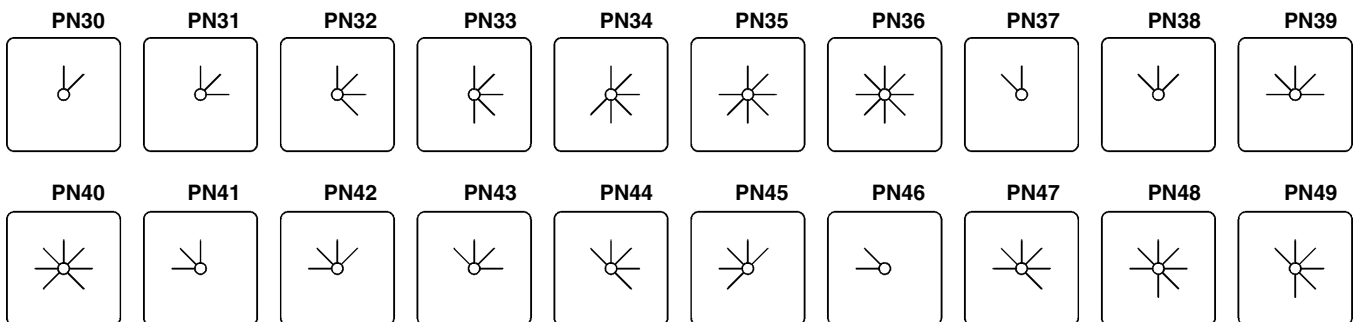

Switching angle 60°

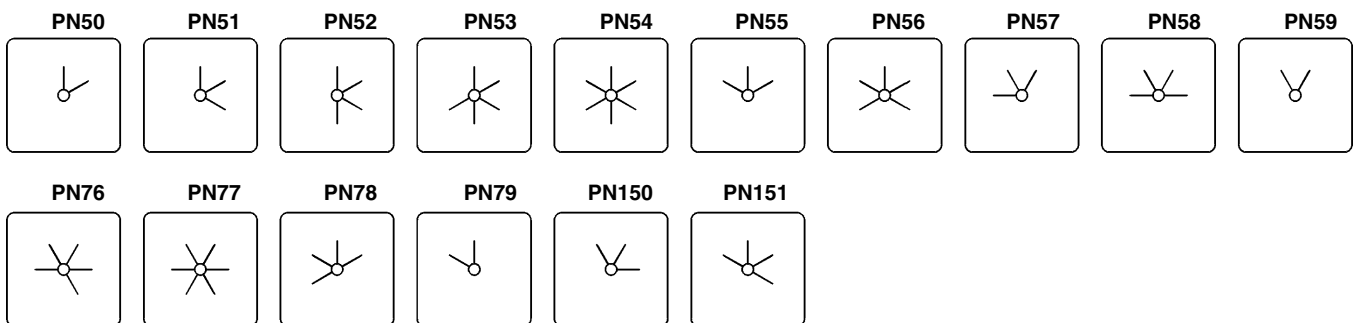

Switching angle 45/90°

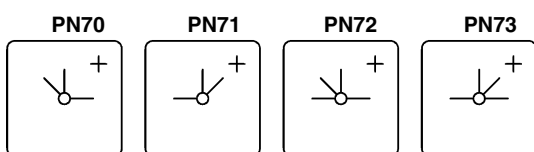

+) Not available for switch types M10, M10H and M20

Switching angles

Switching angle 90°

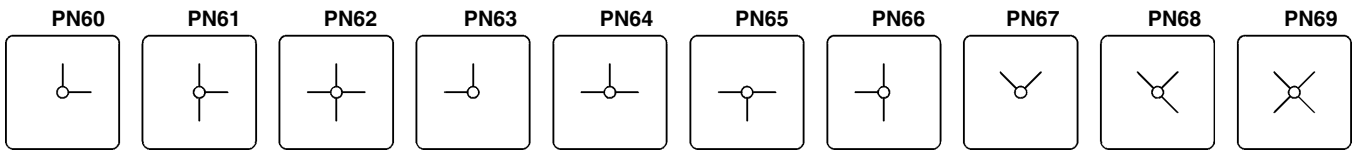

Momentary settings and special combinations

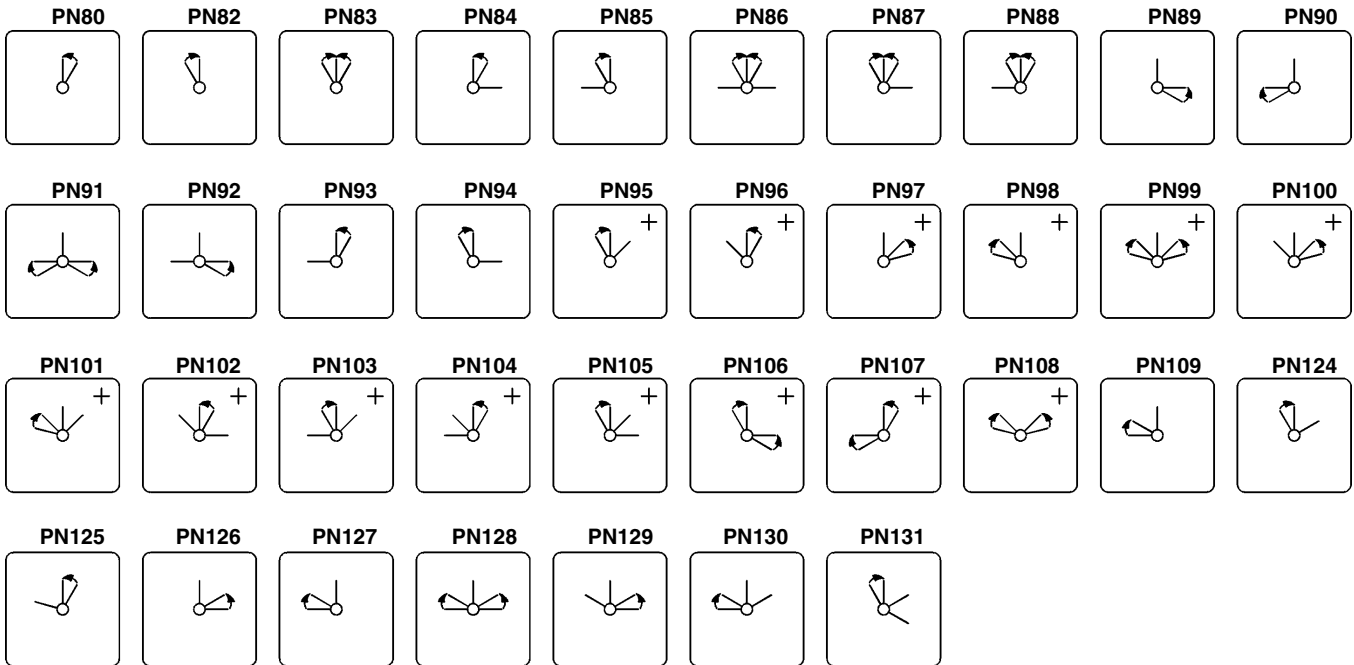

Spring return over several settings

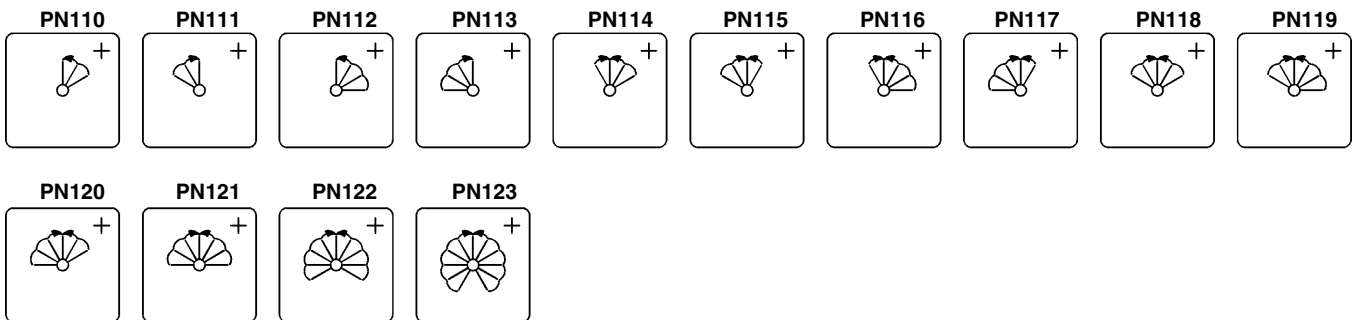

+) Not available for switch types M10, M10H and M20

Handles and drive units

Special actuating mechanisms and ancillary attachments can be provided for many switch sizes and designs. Here, the switch type is followed by order code for the ancillary attachment.

Ordering example: Cam switch N20 GF W3R with removable knob
Order type: **N20 E W3R +STGR**

Dimensions see page 262



	Ordering Code	Suitable for designs	Suitable for switch type
Removable knob drive The operating knob is designed to be removable, and can be withdrawn in any setting. The switch shaft is covered when the knob is withdrawn.	+STGR	E P	M10H, M20, N20, N33F M10, N20, N33F
Removable knob drive 2 The operating knob is designed to be removable. It can be withdrawn in one setting, to be stated when ordering.	+STGR2	E P	M10H, M20, N20, N33F M10, N20, N33F

Door couplings

For switches with door couplings it is necessary to state the installation depth - that is, the distance between mounting level of the switch and the inside edge of the door (dimension T).

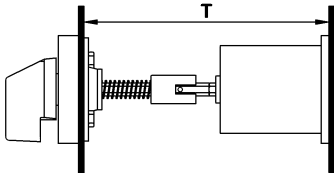

Door couplings are available for switches to be installed in switchgear cabinets or distribution boards with hinged doors. These permit the doors to be opened without removal of the operating knobs.

Ordering example: Cam switch N100 V A3 with lockable door coupling, moisture protected IP65, dimension T=580mm
Order type: **N100 V A3 +TK2FR/580**

Dimensions see page 263



	Ordering Code	Suitable for designs	Suitable for switch type
Door coupling Protection class from front: IP65 5-hole mounting	+TKE/...	V, SM	M10H, M20, N20, N33F
Door coupling locked Protection class from front: IP65 5-hole mounting Doors only open at a given switch setting: unless otherwise stated, the "OFF" setting.	+TK2E/...	V, SM	M10H, M20, N20, N33F
Door coupling locked Protection class from front: IP65 Central fixing Ø22mm Doors only open at a given switch setting: unless otherwise stated, the "OFF" setting.	+TK2Z/...	V, SM	M10H, M20, N20, N33F
Door coupling Protection class from front: IP40 5-hole mounting	+TK/...	V	N40, N60, N80, N100, N200 L100, L160, L400, L600 L800
Door coupling Protection class from front: IP54 5-hole mounting	+TKFR/...	V	N40, N60, N80, N100, N200 L100, L160, L400, L600 L800
Door coupling locked Protection class from front: IP40 5-hole mounting Doors only open at a given switch setting: unless otherwise stated, the "OFF" setting.	+TK2/...	V	N40, N60, N80, N100, N200 L100, L160, L400, L600 L800
Door coupling locked Protection class from front: IP54 5-hole mounting Doors only open at a given switch setting: unless otherwise stated, the "OFF" setting.	+TK2FR/...	V	N40, N60, N80, N100, N200 L100, L160, L400, L600 L800

Lockable switches

Key-operated and lockable switches are supplied with two keys. Additional keys or other types of lock on request.

Ordering example: Cam switch N20 E A3 key operated
Order type: **N20 E A3 +SA**

Dimensions see page 264 and 265



	Ordering Code	Suitable for designs	Suitable for switch type
<p>Key operated switch Lock Willenhal FT101, key removable in all lockable settings. Other types of lock on request. Maximum number of cells M10 - N33F: 6 N40, N60: 2</p> <p>Key operated switch, key removable only in some settings. Add letter of setting where key is removable to ordering code according to the scetch below.</p>	<p>+SA</p> <p>+SA/.</p>	<p>E, V, SM E, V P SMA UP</p>	<p>M10H, M20, N20, N33F N40, N60 M10, N20, N33F, N40, N60 M10H, M20 M10</p>
<p>Key operated switch IP65 Lock Ronis R455, key removable in all lockable settings. Key operated switch, key removable only in some settings. Add letter of setting where key is removable to ordering code according to the scetch above.</p>	<p>+SA</p> <p>+SA/.</p>	<p>Z, ZO</p>	<p>M10H, M20</p>
<p>Key operated switch Lock KABA8, key removable in all lockable settings. Key operated switch, key removable only in some settings. Add letter of setting where key is removable to ordering code according the scetch below.</p>	<p>+SAK</p> <p>+SAK/.</p>	<p>E</p>	<p>M10H, M20</p>
<p>Key operated switch with barrel for special security functions Lock EVVA EHZ50/5 Nickel matt Special version which prevents not only switching but also access to the cable ends and removal of the switch when locked. Maximum number of cells Design E, P: 4 Design UP : 3</p>	<p>+SASI</p>	<p>E P UP</p>	<p>M10H, M20 M10, M20 M10, M20</p>
<p>Key operated switch for special security functions without lock for use of lock EVVA EHZ50/5 or with same dimensions Maximum number of cells Design E, P: 4 Design UP : 3</p>	<p>+SASO</p>	<p>E P UP</p>	<p>M10H, M20 M10, M20 M10, M20</p>

Padlock devices

A range of padlock devices designed to prevent from being turned on by unauthorized personnel, or during maintenance and repair work, can be supplied.

Dimensions see page 266

Ordering example: Cam switch N33F E A3 with interlocking device SV3 suitable for 3 padlocks
Order type: **N33F E A3 +SV3**

Padlock device Description	Ordering Code	Suitable for designs	Suitable for switch type
 <p>Padlock device Standard version black, otherwise red, for 1 or 2 padlocks. Shackles up to Ø6mm Standard version black 64 x 64mm, otherwise red 64 x 64mm</p>	<p>+SV1 +SV1R</p> <p>+SV164 +SV164R</p>	<p>E, V, SM P, PF</p> <p>E, V P, PF</p>	<p>M10H, M20 M10</p> <p>M10H, N20, N33F N20, N33F</p>
 <p>Padlock device Standard version black, otherwise yellow insert plate and red twist knob for 1-3 padlocks. Shackles up to Ø8,5mm Prior to insertion of the first padlock, a red locking ledge must be depressed. This indicates that the switch is locked.</p>	<p>+SV3 +SV3R</p>	<p>E, V E, V E, V PF</p>	<p>N40, N60, N80, L100, L160 N100, N200, L400, L600, L800, L1200 N40, N60, N80, N100, N200</p>
 <p>Padlock device Standard base grey, locking ring black, or with yellow base and red locking ring. Locking ring for 1-3 padlocks. Shackles up to Ø6mm Standard base grey, locking ring black 88 x 88mm, or with yellow base and red locking ring 88 x 88mm</p>	<p>+SV4 +SV4R</p> <p>+SV488 +SV488R</p>	<p>E, V SM P, PF</p> <p>E, V E, V P, PF</p>	<p>M10H, N20, N33F M10H, N20, N33F N20, N33F</p> <p>N20, N33F N40, N60, N80 N40, N60, N80</p>
 <p>Key lock device With a cylinder lock in the lock attachment, one or more switch settings are lockable (state when ordering). The operating knob can only be turned when unlocked. The key can be withdrawn wheter locked or unlocked. Special versions, in which the key cannot be withdrawn when in some (unlockable) settings can be supplied.</p>	<p>+SZ</p>	<p>E, V SM</p>	<p>alle M10H, M20, N20, N33F</p>
<p>Key lock device Special version for on-off switches, in which it is possible to switch off without a key.</p>	<p>+SZ2</p>	<p>E, V SM</p>	<p>alle M10H, M20, N20, N33F</p>

Switch interlocks

A wide range of locks and interlocking devices, designed to prevent accidental or hazardous switching, can be supplied.

Ordering example: Cam switch N20 E A3 with push button switch lock
Order type: **N20 E A3 +DV**

Dimensions see page 267

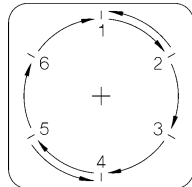
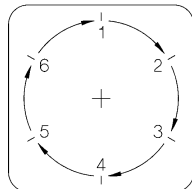
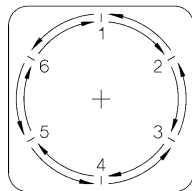

Description	Ordering Code	Suitable for designs	Suitable for switch type
Push button interlock The switch can only be actuated when the pushbutton is simultaneously depressed (two-handed operation).	+DV	E, V	all
Interlock with electrical contact The switch can only be actuated when the pushbutton, which also operates a make and break contact, is actuated (for external interlocking devices or safety measures).	+ET	E, V	all
Magnetic interlock The switch can only be actuated when an electromagnet is simultaneously excited. When ordering, voltage and percentage duty cycle of the magnet coil should be stated.	+MV	E	N20, N33F, N40, N60, N80, N100, N200
Circular switch Switches that have the maximum number of settings for a given switching angle can be made without a stop position, permitting direct switching from the last to the first setting.	+RU	all	all
Backswitch 1 Special version of the circular switch, in which the switch can only be turned in one direction.	+RS1	all	all
Backswitch 2 Special version of the circular switch, in which, in given positions, the switch can only be operated in one direction.	+RS2	all	all

Couplings and stop mechanism

A range of couplings and stop mechanisms for trouble-free operation of switches with a very large number of contacts can be supplied.

Dimension see page 268

Ordering example: Cam switch N200 V ST0113 spread over three columns interconnected by gears
Order type: **N200 V ST0113 +ZK3**

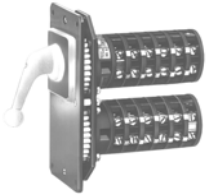

Description	Ordering Code	Suitable for designs	Suitable for switch type
<p>Coupling of two columns For simultaneous drive of two switch columns (with very large number of switch cells or limited installation depth).</p>	+ZK2	E, V	all
<p>Coupling of three columns For simultaneous drive of three switch columns.</p>	+ZK3	E, V	all
<p>Coupling of different switch sizes For attachment of control switches (auxiliary contacts) to larger switches. M10H, M20 in sizes E and H. N20 to N80 in size L.</p>	+ZWK	E	N40, N60, N80, L100, L160 N100, N200, L400, L600, L800, L1200
<p>Delayed action switch Using a delayed action coupling, two switch shafts - a main shaft and delayed shaft - can be coupled, such that the delayed shaft is rotated together with the main shaft once a given angle of rotation is reached (e.g. for off-load return of switches used with pole-changing motors).</p>	+SK	E, V G, GF	N20, N33F, N40, N60, N80 N20
<p>Second stop mechanism With switches in which a large number of contacts is simultaneously operated, use of a second stop mechanism is sometimes necessary, in order to ensure precise switching to the next setting.</p>	+RW2	all	all
<p>Metal stop mechanism for extreme mechanical stress on the stop mechanism, e.g. where many contacts are switched at the same time. Not for PN110 to PN123</p>	+MRW	E, V E, V E, V G, GF	N40, N60, N80, L100, L160 N100, N200, L400, L600, L800, L1200 N20

Special versions

A number of special versions can be supplied for adaptation of switches to various conditions of use.

Ordering example: Cam switch M10H E U3 with large front plate
Order type: **M10H E U3 +GFP**

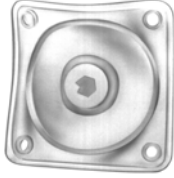

Description	Ordering Code	Suitable for designs	Suitable for switch type
Switch shaft sealing For increased front protection class on IP54.	+WD	E, V SM	N20 to L1200 N20, N33F
Front plate/switch shaft sealing For increased front protection class on IP65. In this version, a wider hole is required for the shaft. Dimensions see page 268	+FPWD	E, V, SM	N20, N33F
Extended switch shaft For adaptation of switch designs V and SM to the enclosure depth. State additional shaft length when ordering.	+VW/...	E, V SM	all M10H, M20, N20, N33F
Large front plate Switch with front plate and operating knob of the next size (for replacement of older, larger switches or aesthetic reasons).	+GFP	E, V, SM	M10H, N20, N33F
Switch with pilot lamp lamp red, 230V lamp red, 400V lamp green, 230V lamp green, 400V	+SLR/230 +SLR/400 +SLG/230 +SLG/400	E P UP	all M10, N20, N33F, N40, N60 M10, N20
Gold plated contacts For electronic circuits with low voltages and currents.	+GK	all	M10H, M20, N20, N33F
Tropical proof type	+TR	all	all
Neon safety switch For all-pole switching off of neon advertisement circuits by the Fire Brigade. Dimensions see page 268	+FEU	E	N20, N33F





Accessories

A number of special versions can be supplied for adaptation of switches to various conditions of use.

Dimensions see page 267

Ordering example: Cam switch N20 E A3 with terminal cover plate
Order type: **N20 E A3 +KLAD**

Description	Ordering Code	Suitable for designs	Suitable for switch type
Terminal cover plate Prevents accidental touching of live terminals (requirement for main switches according to VDE 0113) only for 2 cells for all cells	+KLAD	E, V	N20, N40, N60, N80 N100, N200
	+KLAD	E, V	N33F
Moisture proofing caps Protection class from rear: IP54. For protection of the switch from dust and moisture (e.g. when installed in machine pedestals). For switch mounting from the front and rear. Conical cable entry glands. Maximum number of cells: M10H 7 N20 5 N40 4 N60 2	+FR	E	M10H, N20, N40, N60
 Angled terminals For easy connection of inaccessible switches. Unless otherwise stated, all terminals specified with markings are equipped in this manner. A distinction is drawn between left and right angled terminals. Seen from the switch end, the left terminals are located above left and below right; conversely, right terminals are above right and below left.	+WK	E, V	M20, N20, N40, N60, N80, N100
 Fast-on connectors For 6,3 x 0,8mm plugs.	+AMPZ	E, V	M20, N20
Earth terminals 2 terminals, connected with one another, insulated from switch column: for earth conductors.	+PE	E, V, P, PF PF G, GF	all M10, N20, N33F, N40, N60 N80, N100, N200 N20
Additional rectangular escutcheon plate 1 line Dimensions see page 261	SRE	E, Z, V, SM	all
Big additional rectangular escutcheon plate for 2 lines Dimensions see page 261	SRE2	E, V	M10H, M20, N20, N33F
Spare key for key operated switches with Lock Willenhal FT101	J7101	E, V, P SMA	M10H, M20, N20, N33F, N40 M10H, M20
Spare key for key operated switches with Lock Ronis R455	B4-R455	Z, ZO	M10H, M20
Wrench for switches with central fixing	J7049	Z, ZO	M10H, M20

Switching Programs according to Customer Requirements

As a result of their modular construction, TELUX cam switches are particularly suitable for manufacturing of special variants. According to its function, each pair of contacts in the switch is adapted to the desired program by appropriate design of the cam plate. In the case of switches with an overall switching angle of more than 180°, provision must be made for a cam plate in each switching cell, controlling two opposite, independent contact pairs with matching programs (does not apply to M10, M10H, M20 and N20).

Depending on the desired contact program for the special switch, it may often be impossible to make full use of all switching cells, that is, to include the maximum possible number of contacts. In determining the number of cells or switch length, one-contact cells will sometimes be resorted to.

Switch sizes M10, M10H, M20 and N20 are exceptions to this rule. Here, two cam plates can be built into each cell, so that both contacts are independently controlled (full use of the cells with special programs).

In all special switches with overall switching angles of less than 180°, the number of cells required is calculated by having the total number of contacts in the switching program.

When planning for switches with special programs, choice of the optimum switching angle thus plays an important part. The listing of all the options for lay-out of switch settings, on pages 241 and 242, should be an aid to planning (position numbers PN).

If special markings are to be engraved on the escutcheon plates, it is vital to take account of the available space. It is advisable to use abbreviations.

We provide forms (see page 269) on request, free of charge, to give a clear overview when special programs are being defined. Switch size, design, type of operating knob and desired switching angle, as well as the function of the contacts, are entered on these forms. Provision has also been made in them for entry of details as to escutcheon plate engravings or other special requirements.

Ordering Example

Order sheet D399E		Cam switches with special switching program		Customer:	
Switch Type M4H M10 M10H <input checked="" type="checkbox"/> M20 N20 N33F L100 N40 L160 N60 L400 N80 L600 N100 L800 N200 L1200		Benedict GmbH A-1220 Vienna, Lieblgasse 7 Phone: 251 51-0 Fax: 251 51-88			
Design Panel mounting E Central fixing Z <input checked="" type="checkbox"/> ZO Base mounting V Snap-on mount SM SMA Plastic enclosure P IP65 PF Cast enclosure G IP65 GF		Explanations: Contact closed over several positions <input checked="" type="checkbox"/> Spring return from pos. <input checked="" type="checkbox"/>		Handles Twist knob R (standard) Instrument knob G (standard M4H) <input checked="" type="checkbox"/> Toggle knob K (standard SMA) Pointer knob Z Ball type handle B Lever handle H Hand wheel HR	
Optional extras Circular switch Key removeable <input checked="" type="checkbox"/>				Handle colour black (standard) <input checked="" type="checkbox"/> red grey (standard SMA) white cream-coloured yellow blue	
		Marking for switch position Degree OFF 270 1 0 45 2 90 START 120		Connect. Terminals 1 3 5 7 9 11 13 15 17 19 21 23 25 27 29 31 33 35 37 39 41 43 45 47 Terminals 2 4 6 8 10 12 14 16 18 20 22 24 26 28 30 32 34 36 38 40 42 44 46 48 Connect.	

Order sheet A4 see page 269

Utilization Categories

For easier choice of devices and in order to make the comparison of different products simpler are utilization categories for cam switches according to IEC 947-3, VDE 0660 Part 107 and auxiliary contacts

according to IEC 947-5-1 and VDE 0660 Part 200 determined. The Table below offers diverse utilization categories and assorted test conditions.

Kind of current	Category		Typical applications	Rated operational current	Test conditions for the number of on-load operating cycles (normal service)						Test conditions for making and breaking capacities (operation in fault case)						
	fre-quent oper-ation	infre-quent oper-ation			Make			Break			Make			Break			
					I/l _e	U/U _e	cosφ	I _c /I _e	U _r /U _e	cosφ	I/l _e	U/U _e	cosφ	I _c /I _e	U _r /U _e	cosφ	
Alternating Current	AC20A	AC20B	No-load conditions	all values	-	-	-	-	-	-	-	-	-	-	-	-	
	AC21A	AC21B	Switching of resistive loads including moderate overloads	all values	1	1	0,95	1	1	0,95	1,5	1,05	0,95	1,5	1,05	0,95	
	AC22A	AC22B	Switching of mixed resistive and inductive loads including moderate overloads	all values	1	1	0,8	1	1	0,8	3	1,05	0,65	3	1,05	0,65	
	AC23A	AC23B	Switching of motor loads or other highly inductive loads	0 < I _e ≤ 100A all values 100A < I _e	1	1	0,65	1	1	0,65	10	1,05	0,45	8	1,05	0,45	
	AC2		Slip-ring motors: Starting, plugging	all values	2,5	1	0,65	2,5	1	0,65	4	1,05	0,65	4	1,05	0,65	
	AC3		Squirrel-cage motors: Starting, switching off motors during running	0 < I _e ≤ 100A all values 100A < I _e	I _e ≤ 17A 6 1 I _e > 17A	0,65	I _e ≤ 17A 1 0,17 I _e > 17A	0,65	10	1,05	0,45	8	1,05	0,35	8	1,05	0,35
	AC4		Squirrel-cage motors: Starting, plugging, inching	0 < I _e ≤ 100A all values 100A < I _e	I _e ≤ 17A 6 1 I _e > 17A	0,65	I _e ≤ 17A 6 1 I _e > 17A	0,65	12	1,05	0,45	10	1,05	0,35	10	1,05	0,35
	AC15		Control of electromagnetic loads (> 72VA)	-	10	1	0,7	1	1	0,4	10	1,1	0,3	10	1,1	0,3	
					I/l _e	U/U _e	L/R ¹⁾	I _c /I _e	U _r /U _e	L/R ¹⁾	I/l _e	U/U _e	L/R ¹⁾	I _c /I _e	U _r /U _e	L/R ¹⁾	
Direct current	DC20A	DC20B	No-load conditions	all values	-	-	-	-	-	-	-	-	-	-	-	-	
	DC21A	DC21B	Switching of resistive loads including moderate overloads	all values	1	1	1	1	1	1	1,5	1,05	1	1,5	1,05	1	
	DC22A	DC22B	Switching of mixed resistive a. induct. loads incl. moderate overloads (shunt motors)	all values	1	1	2	1	1	2	4	1,05	2,5	4	1,05	2,5	
	DC23A	DC23B	Switching of highly inductive loads (e.g. series motors)	all values	1	1	7,5	1	1	7,5	4	1,05	15	4	1,05	15	
	DC3		Shunt-motors: Starting, plugging, inching	all values	2,5	1	2	2,5	1	2	4	1,05	2,5	4	1,05	2,5	
	DC5		Series-motors: Starting, plugging, inching	all values	2,5	1	7,5	2,5	1	7,5	4	1,05	15	4	1,05	15	

U_e Rated operational voltage, U Voltage before make, U_r Recovery voltage, I_e Rated operational current, I Current made, I_c Current broken
1) Time in milliseconds (ms)

Note:
By plugging, is understood stopping or reversing the motor rapidly by reversing motor primary connections while the motor is running.
By inching (jogging), is understood energizing a motor once or repeatedly for short periods to obtain small movements of the driven mechanism.

Technical Data

Data according to IEC 947-3, IEC 947-5-1, VDE 0660, EN 60947-3, EN 60947-5-1

Type	M10 P	M10H	M20	N20	N33F	N40	N60	N80	N100	N200
Rated therm. current I_{th} open A	20	20	32	32	50	63	85	115	150	250
Rated therm. current I_{the} encl. A	20	20	32	32	50	63	85	115	150	250
Rated operational voltage U_e V	440	690 ¹⁾	690 ¹⁾	690 ¹⁾	690 ¹⁾	690 ¹⁾	690 ¹⁾	690 ¹⁾	690 ¹⁾	690 ¹⁾
Disconnection property ²⁾ acc. to VDE, IEC up to V	440	440	440	440	440	690	440	440	690	690
Breaking capacity I_{eff}										
3 x 220-440V A	160	160	220	220	260	380	520	740	900	1100
3 x 500V A	-	100	160	160	200	290	380	560	680	850
3 x 660-690V A	-	80	120	120	150	200	290	520	450	-
Utilization categ. AC21A, AC21B Switching of resistive loads including moderate overloads Rated operational current I_e A	20	20	32	32	50	63	85	115	150	250
Utilization categ. AC23A, AC23B Switching of motor loads or other highly inductive loads Rated current I_e 400V A	16	16	30	30	45	45	60	85	105	135
Power rating 220-240V kW	4	4	7,5	7,5	11	15	22	30	40	40
3-phase 3-pole 380-440V kW	7,5	7,5	15	15	22	22	30	45	55	70
500V kW	-	7,5	15	15	22	22	30	45	55	70
660-690V kW	-	7,5	15	15	22	18,5	30	45	45	-
Star-Delta-Switches for squirrel cage motors Power rating 3-phase 3-pole 220-240V kW	3,7	3,7	7,5	7,5	8	11	15	18,5	37	40
380-415V kW	7,5	7,5	15	15	18,5	18,5	25	30	40	70
Utilization category AC3 Switching of three-phase motors Rated current I_e 400V A	12	12	22	22	30	30	50	60	80	135
Power rating 220-240V kW	3	3	5,5	5,5	7,5	7,5	15	18,5	37	40
3-phase 3-pole 380-440V kW	5,5	5,5	11	11	15	15	25	30	40	70
500V kW	-	5,5	11	11	15	15	25	30	40	70
660-690V kW	-	5,5	11	11	15	15	25	30	40	-
Utilization category AC4 squirrel cage motors, inching Power rating 220-240V kW	0,55	0,55	2,2	2,2	3,7	4	5,5	6	11	18,5
3-phase 3-pole 380-440V kW	1,5	1,5	4	4	5,5	7,5	11	15	18,5	35
500V kW	-	1,5	4	4	5,5	7,5	11	15	22	35
660-690V kW	-	1,5	4	4	5,5	7,5	11	15	22	-
Utilization category AC15 Control of electromagnetic loads, contactors, Rated current I_e up to 240V A	6	6	12	12	16	-	-	-	-	-
380-440V A	4	4	6	6	7	-	-	-	-	-
2-pole in series 500V A	-	5	8	8	10	-	-	-	-	-
Utilization categ. DC21A, DC21B Switching of resistive loads Time constant $L/R \leq 1ms$ Rated current I_e 1-pole 30V A	20	20	32	32	40	63	80	100	150	250
60V A	4	4	6	6	20	30	30	30	-	-
110V A	0,6	0,6	3	3	4	6	6	6	-	-
220V A	0,5	0,5	0,8	0,8	0,8	1,3	1,3	1,3	2,5	2,5
440V A	-	-	0,4	0,4	0,4	0,6	0,6	0,6	0,7	0,7
Utilization category DC3 - DC5 Switching of shunt motors and series motors Time constant $L/R \leq 15ms$ Rated current I_e 1-pole 30V A	8	8	13	13	16	25	32	40	60	100
60V A	1	1	2,4	2,4	4	12	12	12	-	-
110V A	0,3	0,3	0,5	0,5	1,6	2,4	2,4	2,4	-	-
Protection class of terminals ¹⁾	IP00	IP20	IP00	IP00	IP20	IP00	IP00	IP00	IP00	IP00

1) suitable for: earthed-neutral systems, overvoltage category I to III, pollution degree 3 (standard-industry): $U_{imp} = 6kV$. Data for other conditions on request

2) valid for lines with grounded common neutral termination, overvoltage category III, pollution degree 3.

3) Protection degree of the terminals with connected insulated conductor. Additional protection with terminal cover (KLAD).

Technical Data

Data according to IEC 947-3, IEC 947-5-1, VDE 0660, EN 60947-3, EN 60947-5-1

Type		M10 P	M10H	M20	N20	N33F	N40	N60	N80	N100	N200
Cable cross-sections											
solid	mm ²	1-2,5	1-2,5 ¹⁾	1,5-6	1,5-6	2,5-10	2,5-16 ¹⁾	6-25 ¹⁾	6-35	10-50 ¹⁾	50-150
flexible	mm ²	0,75-2,5	0,75-2,5 ¹⁾	1-4	1-4	1,5- 6	2,5-10 ¹⁾	6-25 ¹⁾	6-35	10-35 ¹⁾	35-120
flexible w. multicore cable end	mm ²	0,75-2,5	0,75-1,5	1-4	1-4	1,5- 6	2,5-6	6-16	6-35	10-25	-
Conductors to clamp per pole		2	2	2	2	2	2	1	1	1	1
Size of terminal screw		M3	M3,5	M4	M4	M4	M5	2xM5	2xM5	2xM6	M10
Tightening torque	Nm lb.inch	0,6-1,2 5-11	0,8-1,4 7-12	1,2-1,8 11-16	1,2-1,8 11-16	1,2-1,8 11-16	2,5-3 22-26	2,5-3 22-26	2,5-3 22-26	3,5-4,5 31-40	10 88
Short circuit protection											
Max. fuse size	gL (gG) A	20	20	35	35	50	63	100	125	160	250
Rated short-time withstand current (1sec. current)	A	250	250	400	400	500	800	1000	1400	1800	3000
Rated conditional short-circuit current	kA _{eff}	10	10	10	10	10	10	10	10	10	10
Short-time capacity											
Load duration	3s A	100	100	200	200	350	400	600	720	1000	2000
	10s A	60	60	130	130	230	250	400	480	600	1200
Note: Ratings applies to contacts already closed	30s A	35	35	85	85	110	160	250	300	500	600
	60s A	25	25	65	65	80	110	200	250	370	480
Power loss at AC21A											
per pole	A W	20 0,6	20 0,5	32 0,9	32 1,1	50 1,9	63 2	85 2,8	115 4,4	150 5,7	250 21
Switching of capacitive loads											
maximum making capacity up to 500V	A	140	140	300	300	350	400	600	700	900	1800

Data according to UL and cUL

Type		M10 P	M10H	M20	N20	N33F	N80	N100	N200	L400	
Rated voltage	V~	300	600	600	600	600	600	600	600	600	
Rated operational current	"General Use" A with jumper A	20 15	20 -	35 25	35 25	60 40	115 80	130 -	250 -	350 -	
DOL-Rating 3-phase	110-120V hp 200-208V hp 220-240V hp	1½ 2 3	1½ 2 3	5 5 5	5 5 5	7½ 10 15	10 15 20	15 25 30	15 25 30	15 25 30	
	440-480V hp 550-600V hp	- -	5 7½	10 15	10 15	25 30	40 50	40 50	60 75	60 75	
DOL-Rating 1-phase	110-120V hp 200-208V hp 220-240V hp	½ 1 1½	½ 1 1½	1½ 3 5	1½ 3 5	3 5 7½	5 7½ 10	7½ 15 15	7½ 15 20	7½ 15 20	
Fuse size (RK5) 5kA / 600V	Manual Motor Controller and Motor Disconnect	A	40 ²⁾	40	80	80	150	200	300	350	350
Heavy pilot duty	AC	A300	A600	A600	A600	A600	-	-	-	-	
Cable cross sections											
solid	AWG	12 - 20	12 - 20	10 - 18	10 - 18	10 - 12	10 - 12	10 - 14	-	-	
flexible	AWG	14 - 20	14 - 20	8 - 18	8 - 18	6 - 12	2 - 12	1 - 14	250kcmil	500kcmil	
Tightening torque	Nm lb.inch	1.7 15	1-1.7 9-15	1.7-2.8 15-25	1.7-2.8 15-25	2.3-2.8 20-25	2.8 25	4.5 40	- -	- -	

1) Maximum cable cross-section with prepared conductor

2) 5kA / 300V

Technical Data

Data according to IEC 947-3, IEC 947-5-1, VDE 0660, EN 60947-3, EN 60947-5-1

Type		L100	L160	L400	L600	L800	L1200
Rated insulation voltage U_i	V	690 ²⁾	690 ²⁾	690 ²⁾	690 ²⁾	690 ²⁾	690 ²⁾
Rated thermal current I_{th} open	A	125	180	400	600	800	1200
Rated thermal current I_{the} encl.A	125	180	400	600	800	1200	
with conductor	mm ²	50	70	40x5	40x10	busbar 2x40x10	busbar 2x50x10
Utilization category AC21A, AC21B							
Switching of resistive loads, including moderate overloads							
Rated operational current I_e	A	125	180	400	400	400	400
Shot-time current-carrying capacity							
Load duration	1s	-	-	4800	6500	8500	10000
	3s	800	1200	3600	5000	6500	8000
	10s	500	800	2000	3200	4000	5800
Note: Ratings applies to contacts already closed	30s	320	480	1200	1700	2200	3200
	60s	180	380	960	1300	1700	2300
Cable cross-sections							
solid or stranded	mm ²	25-50 ¹⁾	cable lug	busbar	busbar	busbar	busbar
flexible	mm ²	25-50 ¹⁾	70	40x5	40x10	2x40x10	2x50x10
flexible with multicore cable end	mm ²	25-35	-	-	-	-	-
Size of terminal screw		2xM5	M8	M12	M16	M16	M16
Number of conductors to clamp per pole		1	1	1	2	1	1
Short circuit protection							
Max. fuse size	slow, gL (gG) A	125	200	400	630	800	1250

1) Maximum cable cross-section with prepared conductor

2) suitable for: earthed-neutral systems, overvoltage category I to III, pollution degree 3 (standard-industry); $U_{imp} = 6kV$. Data for other conditions on request

Dimensions (mm)

Panel mounting E M10 - N100

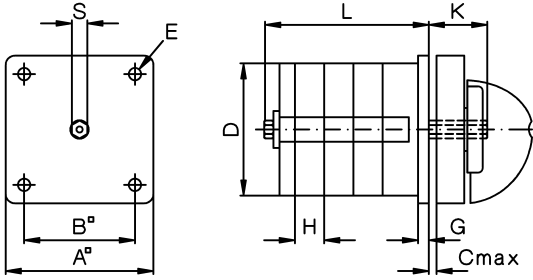

N200

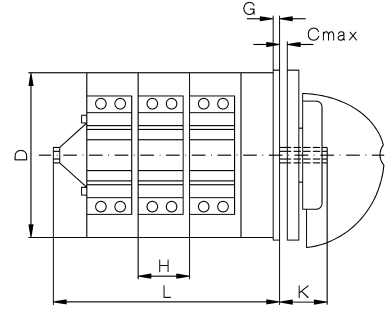
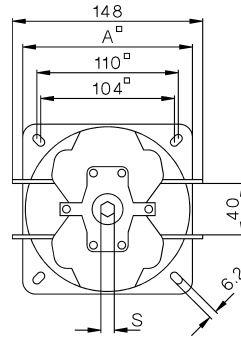

Type	A	B	C	D	D1	D2	D3	E	G	H	K	S
M10H	48	36	5	44 ¹⁾	5	8	-	4	3,5	9,5	19	SW5
M20	48	36	5	56	5	8	57	4	3,5	12,5	19	SW5
N20	64	48	5	56	5	12	57	4,2	3	12,5	20	SW7
N33F	64	48	5	58 ²⁾	5	12	-	4,2	3	15,5	20	SW7
N40	86	68	7	80	6	12	82	5,2	3,5	18	24,5	SW9
N60	86	68	7	80	6	12	82	5,2	3,5	29,5	24,5	SW9
N80	86	68	7	80	6	12	82	5,2	3,5	29,5	24,5	SW9
N100	132	110	9	128	7	16	129	6,2	5	30	37	SW12
N200	132	110	9	128	7	16	-	6,2	5	40	37	SW12

1) 44,5 x 42

2) 58 x 58

Mounting holes: built in from ear

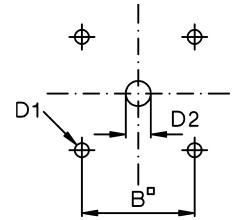

Type	Dimension L with .. cells														
	1	2	3	4	5	6	7	8	9	10	11	12	13	14	15
M10H	36,5	46	55,5	65	74,5	84	93,5	103	112,5	122	131,5	141	-	-	-
M20	38,5	51	63,5	76	88,5	101	113,5	126	138,5	151	163,5	176	-	-	-
N20	40,5	53	65,5	78	90,5	103	115,5	128	140,5	153	165,5	178	190,5	203	215,5
N33F	44	59,5	75	90,5	106	121,5	137	152,5	168	183,5	199	214,5	230	245,5	261
N40	52,5	70,5	88,5	106,5	124,5	142,5	160,5	178,5	196,5	214,5	232,5	250,5	268,5	286,5	304,5
N60	64	93,5	123	152,5	182	211,5	241	270,5	300	329,5	359	388,5	-	-	-
N80	64	93,5	123	152,5	182	211,5	241	270,5	300	329,5	359	388,5	-	-	-
N100	88	118	148	178	208	238	268	298	328	358	388	418	-	-	-
N200	96	136	176	216	256	296	336	376	416	456	496	536	-	-	-

Mounting holes: built in from front

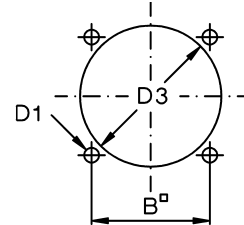

Central fixing Z M10H, M20, N33F

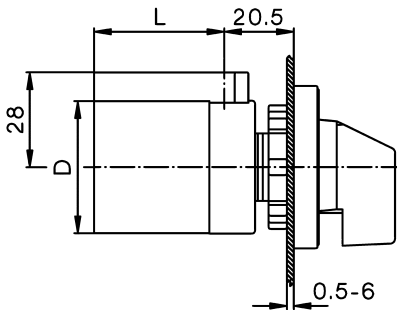

Central fixing without escutcheon plate ZO M10H, M20

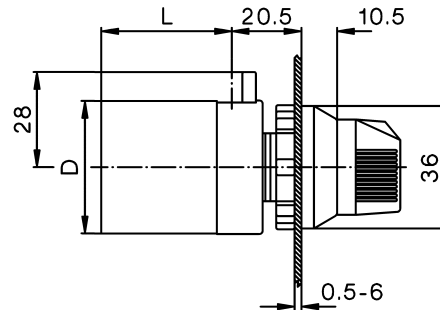

Mounting hole:

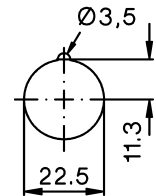

Further dimensions see tables above

Mini-Cam Switches M4H

Panel mounting E

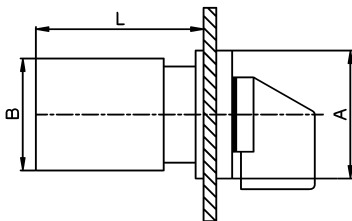

Central fixing Z, ZO

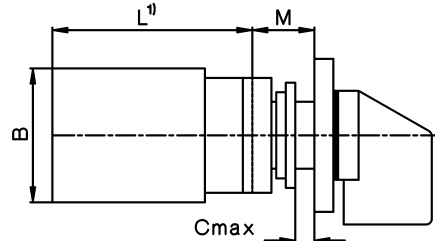

ZO

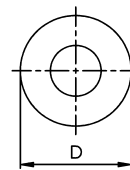

Z

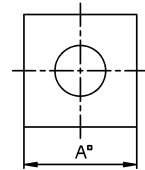

Type	A	B	D	M	Dimension L with .. cells								
					1	2	3	4	5	6	7	8	
M4H	mm	30	28	29,5	12,5	38,5	50,5	62,5	74,5	86,5	98,5	110,5	122,5

Mounting holes see page 230

Flush mounting UP M10

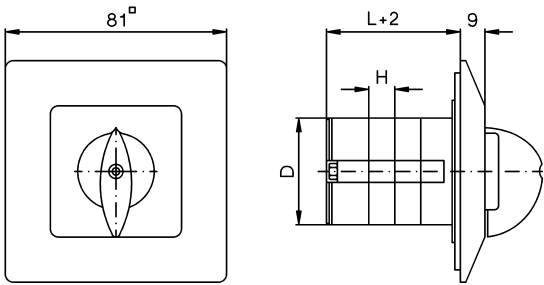

Base mounting V M10H - N100

N200

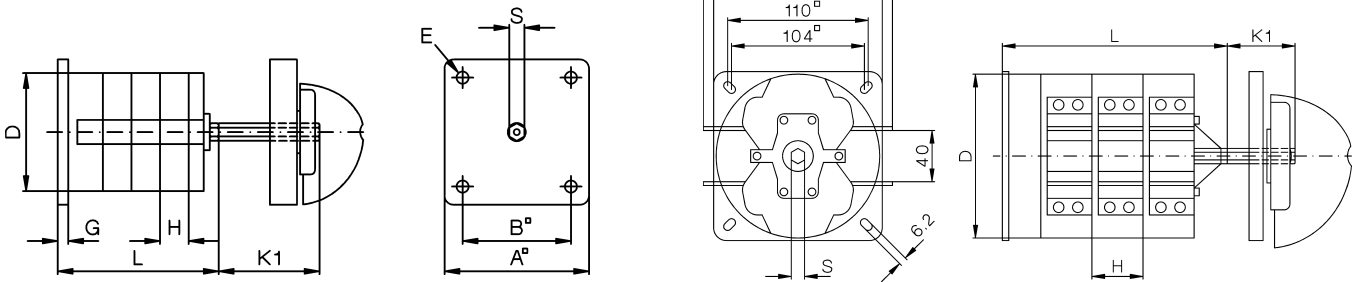

Type	A	B	D	D1	D2	E	G	H	I	K	K1	S
M10	48	36	39	5	8	4	3,5	9,5	6	19	41	SW5
M10H	48	36	44 ¹⁾	5	8	4,2	3	9,5	6	19	41	SW5
M20	48	36	56	5	8	4,2	3	12,5	6	19	47	SW5
N20	64	48	56	5	12	4,2	3	12,5	0	20	29	SW7
N33F	64	48	58 ²⁾	5	12	4,2	3	15,5	0	20	31,5	SW7
N40	86	68	80	6	12	5,2	3,5	18	-	-	38,5	SW9
N60	86	68	80	6	12	5,2	3,5	29,5	-	-	49,5	SW9
N80	86	68	80	6	12	5,2	3,5	29,5	-	-	49,5	SW9
N100	132	110	128	7	16	6,2	5	30	-	-	79,5	SW12
N200	132	110	128	7	16	6,2	5	40	-	-	104	SW12

Mounting holes: for escutcheon plate

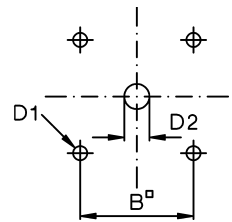

- 1) 42 x 44,5
- 2) 58 x 58

Type	Dimensions L with .. cells														
	1	2	3	4	5	6	7	8	9	10	11	12	13	14	15
M10	34,5	44	53,5	63	72,5	82	91,5	101	110,5	120	129,5	139	-	-	-
M10H	36,5	46	55,5	65	74,5	84	93,5	103	112,5	122	131,5	141	-	-	-
M20	38,5	51	63,5	76	88,5	101	113,5	126	138,5	151	163,5	176	-	-	-
N20	40,5	53	65,5	78	90,5	103	115,5	128	140,5	153	165,5	178	190,5	203	215,5
N33F	44	59,5	75	90,5	106	121,5	137	152,5	168	183,5	199	214,5	230	245,5	261
N40	52,5	70,5	88,5	106,5	124,5	142,5	160,5	178,5	196,5	214,5	232,5	250,5	268,5	286,5	304,5
N60	64	93,5	123	152,5	182	211,5	241	270,5	300	329,5	359	388,5	-	-	-
N80	64	93,5	123	152,5	182	211,5	241	270,5	300	329,5	359	388,5	-	-	-
N100	88	118	148	178	208	238	268	298	328	358	388	418	-	-	-
N200	96	136	176	216	256	296	336	376	416	456	496	536	-	-	-

Snap-on mounting SM M10H - N33F for 35mm DIN-rail mounting according to DIN EN 50022

Dimensions see tables above

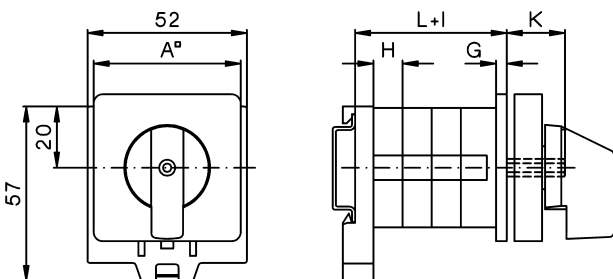

Switch with installation cover SMA M10H, M20 for 35mm DIN-rail mounting according to DIN EN 50022

Type	Dimension X with .. cells					Dimension Y with .. cells				
	1, 2	3	4	5	6	1, 2	3	4	5	
M10H	44	44	61	76	60	60	75	90	90	
M20	44	61	76	76	60	75	90	90	90	

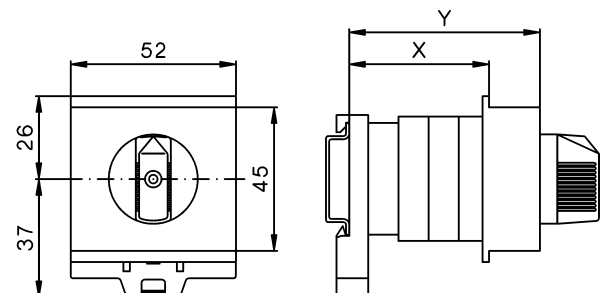

Plastic enclosed switches P, PF M10 - N60

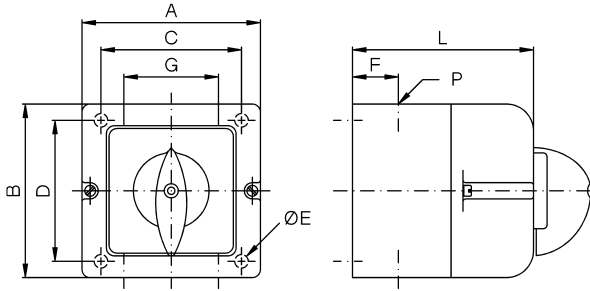

N60, N80

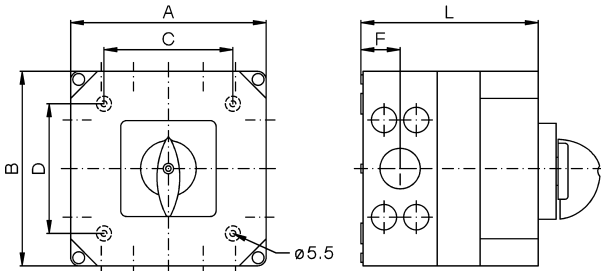

N100, N200

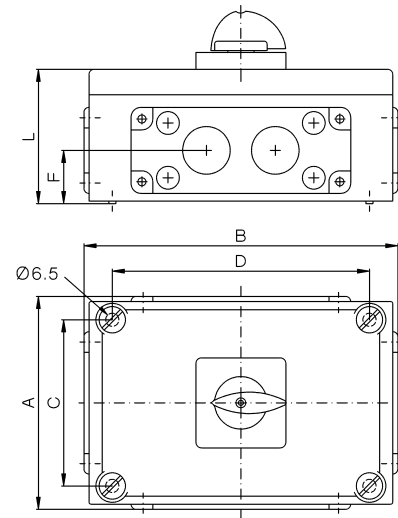

1) knock outs for M40/M32 + 4x M20 at top and bottom
M32/M25 + 4x M20 at the right and left hand side,

2) 2 flange plates with hole 50,5 at top and bottom

3) 2 flange plates with hole 50,5 at top and bottom, can also be mounted at the right and left hand side

Type	A	B	C	D	E	F	G	P	Dimension L with .. cells					
									1	2	3	4	5	6
M10	66	64	50	36	5	15,5	26	M20	43	52	62	71	81	90
N20	82	78	57	53	4,5	17	29	M20	66	66	80	94	108	122
N33F	112	108	85	50	5	20	50	M25	92	92	92	110	128	146
N40	112	108	85	50	5	20	50	M25	92	92	110	128	146	164
N60	112	108	85	50	5	20	50	M25	92	110	-	-	-	-
N60	182	180	120	120	5,5	36,5	-	1)	-	-	165	215	215	-
N80	182	180	120	120	5,5	36,5	-	1)	110	110	165	215	215	-
N100	210	310	165	255	6,5	52,5	-	2)	130	130	180	-	-	-
N200	310	310	255	255	6,5	52,5	-	3)	130	180	230	-	-	-

Motor terminal box mounting KE M10 - N33F

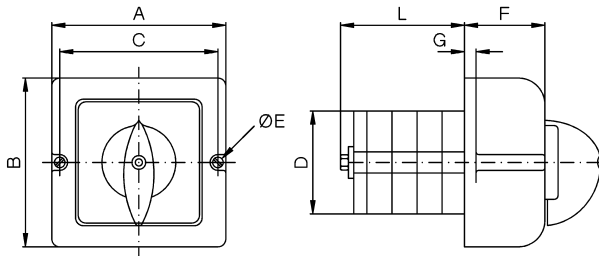

Mounting holes

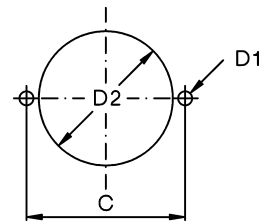

Type	A	B	C	D	D1	D2	E	F	G	Dimension L with .. cells					
										2	3	4	5	6	
M10	66	64	58	39	4	48	3,2	24	6	22	31,5	41	50,5	60	
N20	82	78	71	48	5	57	4,2	34	5	24,5	37	49,5	62	74,5	
N33F	112	108	100	56	5	70	4,2	49	11	32,5	48	63,5	79	94,5	

Plastic enclosed motor starter PM N20

Typ	P	Dimension L with .. cells					
		1	2	3	4	5	6
N20	M25	80	80	80	92,5	105	117,5

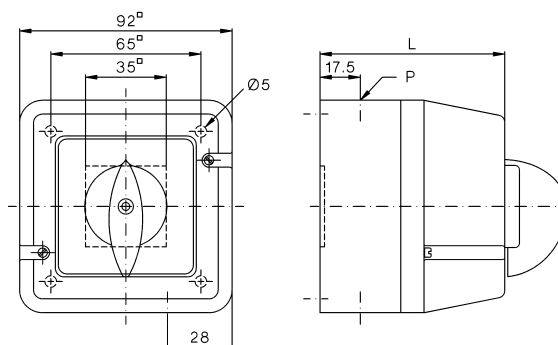

Cast aluminium enclosed switches G, GF N20

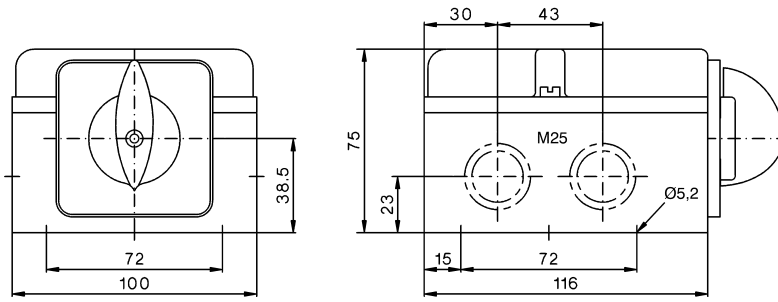

Plastic enclosure horizontal PLF (Replacement for cast aluminium enclosure G, GF) N40, N60, N80

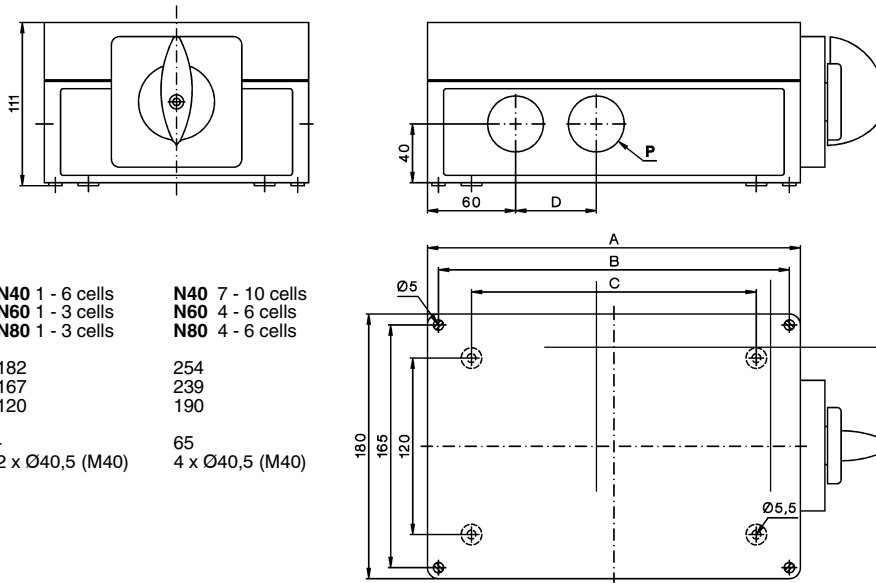

Type	N40 1 - 6 cells	N40 7 - 10 cells
A	182	254
B	167	239
C	120	190
D	-	65
P	2 x Ø40,5 (M40)	4 x Ø40,5 (M40)

Load Switches

Panel mounting E
L100 - 400, L800, L1200

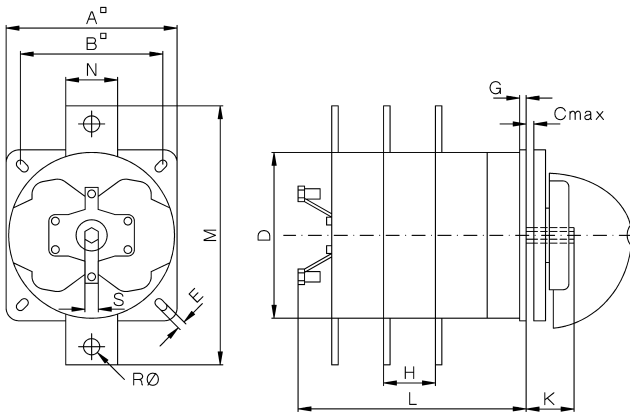

L600

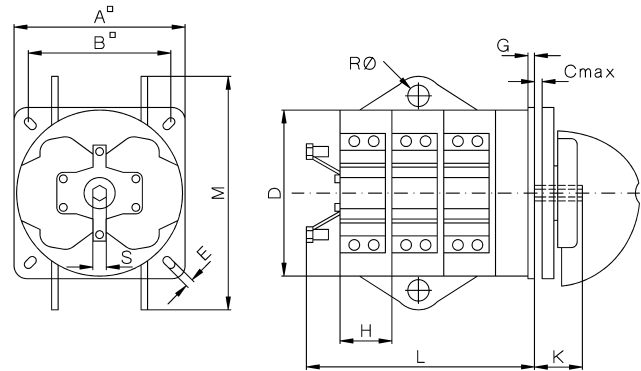

Base mounting V
L100 - 400, L800, L1200

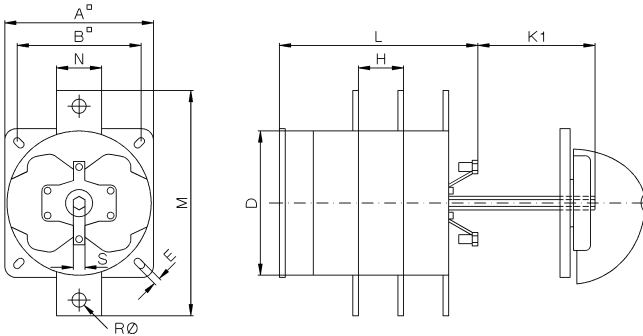

L600

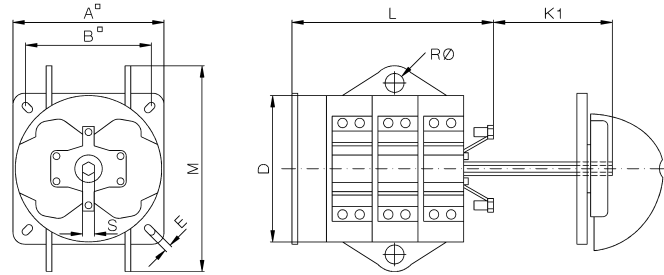

Type	A	B	C	D	D1	D2	E	G	H	K	K1	M	N	R	S
L100	86	68	7	80	6	12	5,2	3,5	18	24,5	38,5	103	27	-	SW9
L160	86	68	7	80	6	12	5,2	3,5	29,5	24,5	38,5	115	-	8,5	SW9
L400	132	110	9	128	7	16	6,2	5	40	37	104	200	40	12,5	SW12
L600	132	110	9	128	7	16	6,2	5	40	37	104	180	-	16,5	SW12
L800	132	110	9	128	7	16	6,2	5	40	37	104	240	40	16,5	SW12
L1200	132	110	9	128	7	16	6,2	5	40	37	104	240	40	16,5	SW12

Mounting holes :

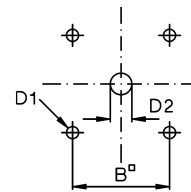

Type	Dimension L with .. cells											
	1	2	3	4	5	6	7	8	9	10	11	12
L100	52,5	70,5	88,5	106,5	124,5	142,5	160,5	178,5	196,5	214,5	232,5	250,5
L160	64	93,5	123	152,5	182	211,5	241	270,5	300	329,5	359	388,5
L400	96	136	176	216	256	296	336	376	416	456	496	536
L600	96	136	176	216	256	296	336	376	416	456	496	536
L800	96	136	176	216	256	296	336	376	416	456	496	536
L1200	96	136	176	216	256	296	336	376	416	456	496	536

Operating Knobs and Handles

Instrument knob G.

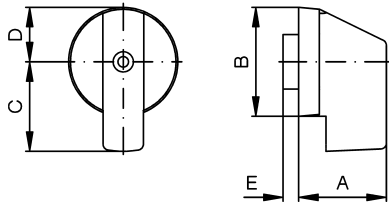

Type	A	B	C	D	E
M10, M10H, M20	23	28	24	14	4
N20, N33F	27	36	32	18	3
N40, N60, N80, L100, L160	36	47	42	24	3,5
N100, N200	48,10	75	63	37,5	-

Twist knob R.

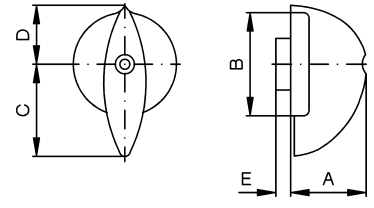

Type	A	B	C	D	E
M10, M10H, M20	20,5	28	25	15	4
N20, N33F	24	36	29,5	19	3
N40, N60, N80, L100, L160	31	49	41	28	3,5
N100, N200, L400, L600, L800, L1200	50	75	62	41	2,5

Toggle knob K.

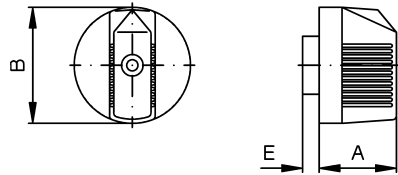

Type	A	B	E
M10, M10H, M20	18,5	28	4
N20, N33F	24	36	3

Hand wheel HR

N100, N200,
L400, L600, L800, L1200

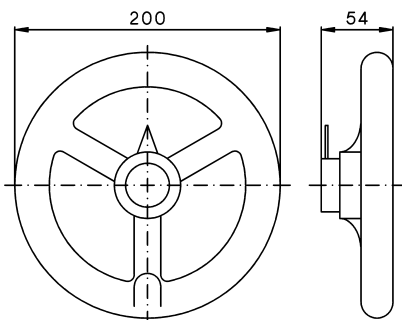

Ball type handle B.

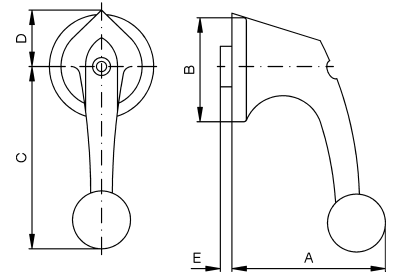

Type	A	B	C	D	E
N20, N33F	53	36,5	64	21	3
N40, N60, N80, L100, L160	62	49	82	31	3,5
N100, N200, L400, L600, L800, L1200	63	75	110	45	2,5

Code number for colour

grey	.1	white	.5
black	.2	blue	.6
red	.3	yellow	.7
cream-coloured	.4	euro-white	.8

Escutcheon plates

Escutcheon plate

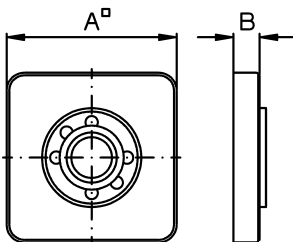

Type	A	B
M10, M10H, M20	48	7,5
N20, N33F	64	7,5
N40, N60, N80, L100, L160	88	8
N100, N200, L400, L600, L800, L1200	132	9

Rectangular additional plate SRE

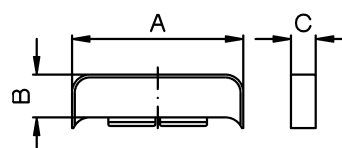

Type	A	B	C
M10, M10H, M20	48	12	7,5
N20, N33F	64	14	7,5
N40, N60, N80, L100, L160	88	22	8
N100, N200, L400, L600, L800, L1200	132	31	9

Special drives

**Removable knob drive STGR, STGR2
M10H - N33F**

Type	B	C	D1	D2	D3
M10H, M20	36	5	5	12	18
N20, N33F	48	5	5	12	18

Replace dimension D2 with dimension D3 for STGR2
Dimension L see page 256

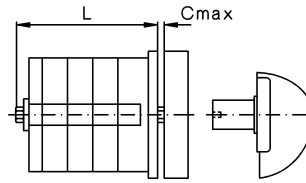
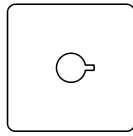

Mounting holes

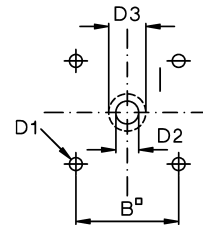

Door couplings

Dimension T is a minimum value. In case of order the dimension T is necessary.

Door coupling TK, TKFR N40 - L1200

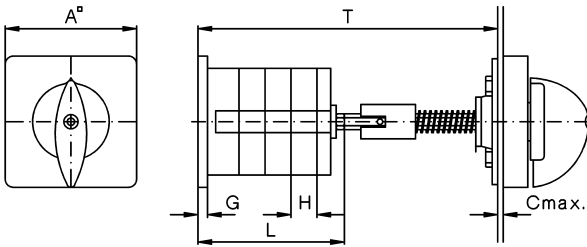

Door coupling, lockable TK2, TK2FR N40 - L1200

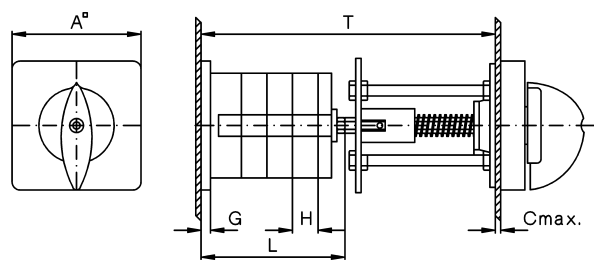

Door coupling TKE, TK2E M10H, M20, N20, N33F

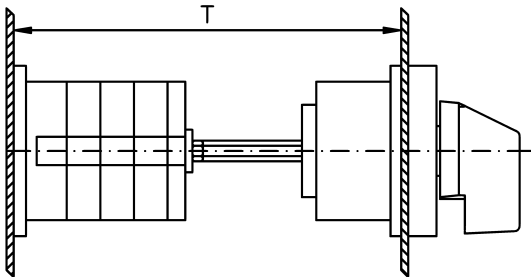

Mounting holes: TK, TKFR, TK2, TK2FR TKE, TK2E

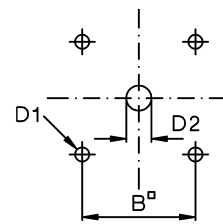

Door coupling, lockable TK2Z M10H, M20, N20, N33F

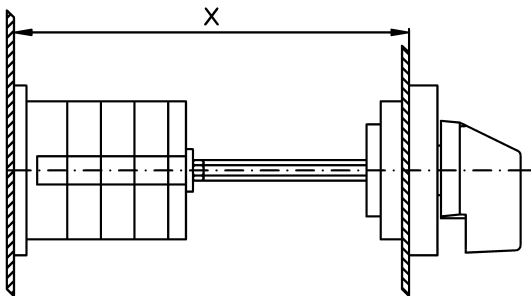

Mounting holes: TKZ

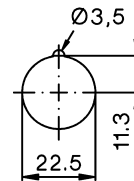

Further dimensions see pages 256 and 257.

Dimension T is a minimum value dependent on switch Type and number of cells. For ordering dimension T is necessary

Type	A	B	C	D1	D2	Minimum dimension T with .. cells							
						1	2	3	4	5	6	7	8
M10H	48	36	5	5	8	108	117,5	127	136,5	146	155,5	165	174,5
M20	48	36	5	5	8	100	112,5	125	137,5	150	162,5	175	187,5
N20	64	48	5	5	10	100	112,5	125	137,5	150	162,5	175	187,5
N33F	64	48	5	5	10	103	118,5	134	149,5	165	180,5	196	211,5
N40	88	48	7	6	12	134	152	170	188	206	224	242	260
N60	88	48	7	6	12	145,5	175	245,5	234	263,5	293	322,5	352
N80	88	48	7	6	12	145,5	175	245,5	234	263,5	293	322,5	352
N100	132	110	9	7	15	202	232	262	292	322	352	382	412
N200	132	110	9	7	15	212	252	292	332	372	412	452	492
L100	88	48	7	6	12	-	152	-	188	-	224	-	260
L160	88	48	7	6	12	145,5	175	245,5	234	263,5	293	322,5	352
L400	132	110	9	7	15	212	252	292	332	372	412	452	492
L600	132	110	9	7	15	-	-	292	-	-	412	-	-
L800	132	110	9	7	15	-	252	-	332	-	412	452	492
L1200	132	110	9	7	15	-	-	292	-	-	412	-	-

Key operated switches SA

Panel mounting E
M10 - N60

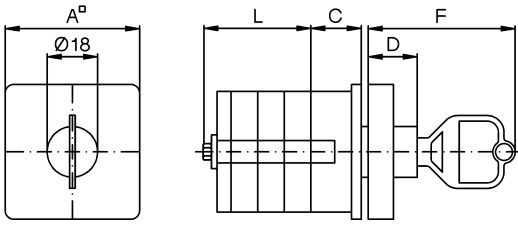

Type	A	B	C	D	D1	D2	F
M10H, M20	48	36	18	17,5	5	18,5	52,5
N20, N33F	64	48	10	17,5	5	18,5	52,5
N40, N60	88	68	23,5	15	6	18,5	50

Mounting holes

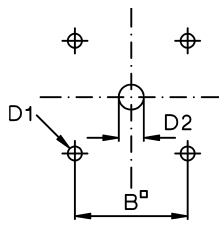

Dimension L see page 256

Base mounting V
M10 - N60

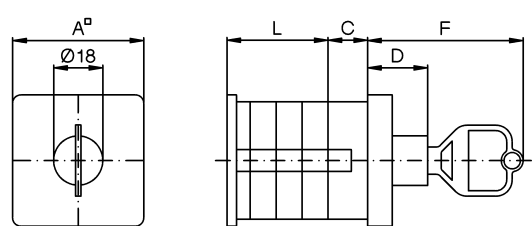

Type	A	C	D	F
M10H, M20	48	18	22	57
N20, N33F	64	8	22	57
N40, N60	88	15	15	50

Dimension L see page 257

Central fixing Z
M10H Z ... + SA
M20 Z ... + SA

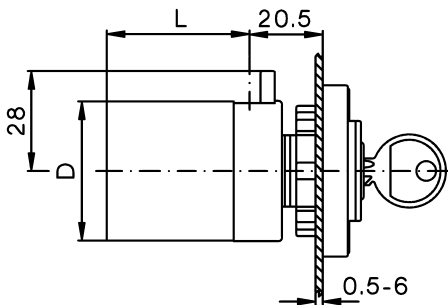

Central fixing without escutcheon plate ZO
M10H ZO ... + SA
M20 ZO ... + SA

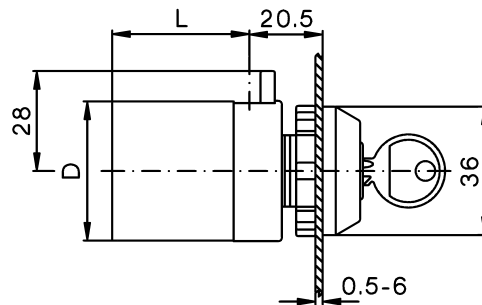

Mounting holes:

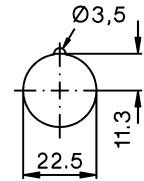

Further dimensions see page 256

DIN rail mounting SMA
M10H, M20

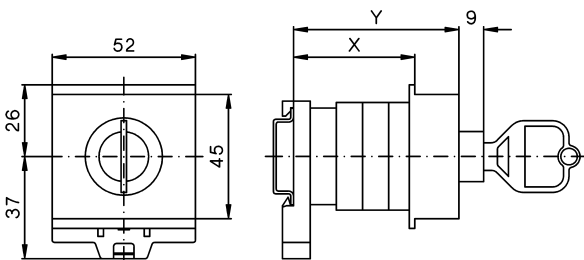

Type	Dimension X with .. cells				Dimension Y with .. cells			
	1	2	3	4	1	2	3	4
M10H	44	75	75	91	60	90	90	107
M20	59	75	75	91	75	90	90	107

Flush mounting UP
M10

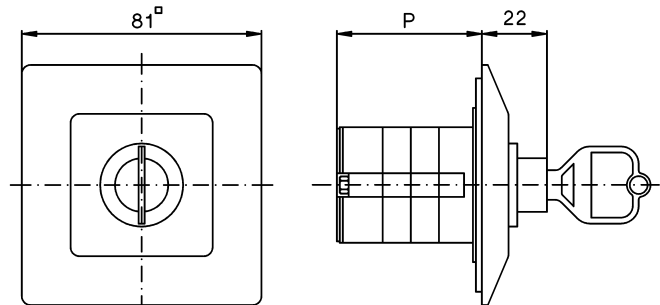

Type	Dimension P with .. cells	
	1	2
M10	47,5	57

Plastic enclosed switches P, PF
M10, N20, N33F, N40, N60

Type	Dimension P with .. cells			
	1	2	3	4
M10	62	71	81	90
N20	66	80	94	108
N33F	92	110	110	128
N40	92	110	-	-
N60	110	-	-	-

Further dimensions see page 258

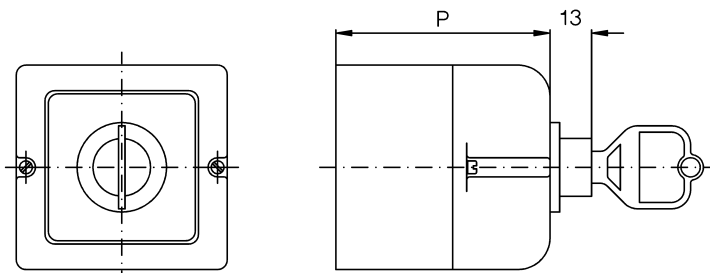

Key operated switches

Key operated switch SAK
Panel mounting E M10H, M20

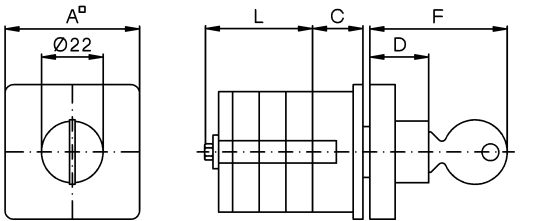

Type	A	B	C	D	D1	D2	F
M10H, M20	48	36	25	21	5	22,5	49

Mounting holes

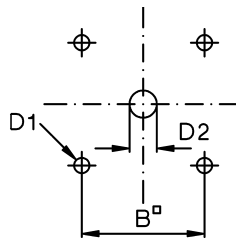

Key operated switch SAK
Base mounting V M10H, M20

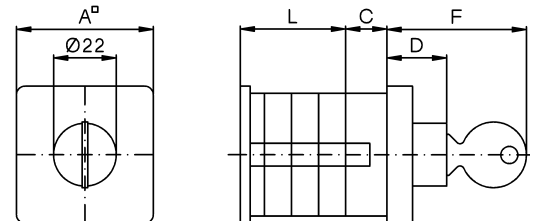

Type	A	C	D	F
M10H, M20	48	25	21	49

Key operated switch SASI
Panel mounting E M10, M20

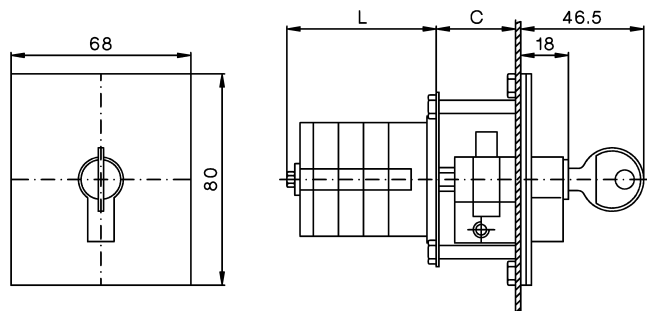

Mounting holes M10, M20

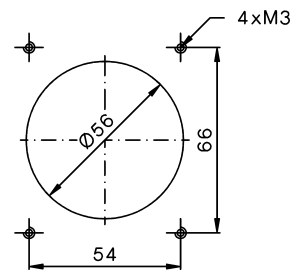

Type	M10	M20
C	20	20

Dimension L see page 256

Key operated switch SASI
Plastic enclosed P M10, M20

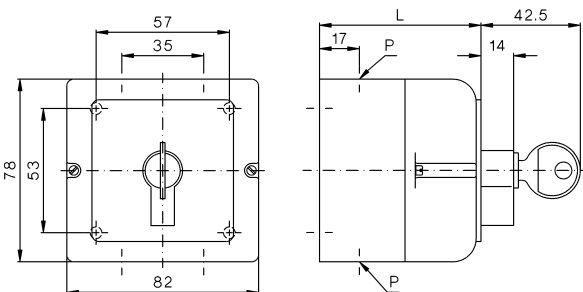

Typ	Dimension P with .. cells				P
	1	2	3	4	
M10	67	79,5	92	104,5	2xM20
M20	79,5	92	104,5	117	2xM20

Key operated switch SASI
Flush mounting UP M10, M20

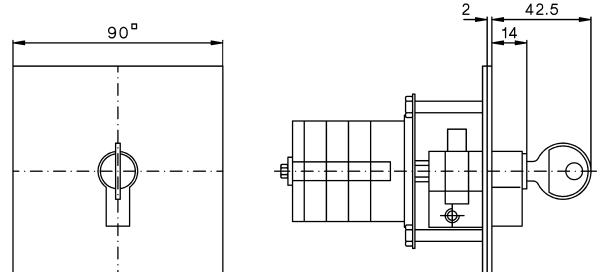

Padlock devices

Padlock device SV1 (max. 2 padlocks with stirrup $\varnothing 6\text{mm}$)
M10H, M20
Mounting holes design E, V

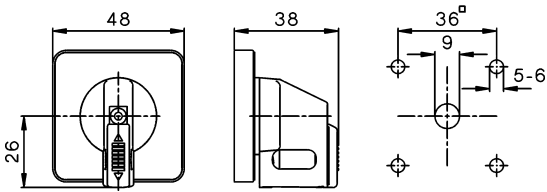

Padlock device SV164
M10H - N33F
Mounting holes design E, V

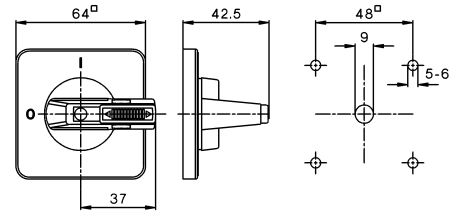

Padlock device SV3 (max. 3 padlocks with stirrup $\varnothing 8,5\text{mm}$)
Panel mounting E
N20 - N200, L100 - L1200

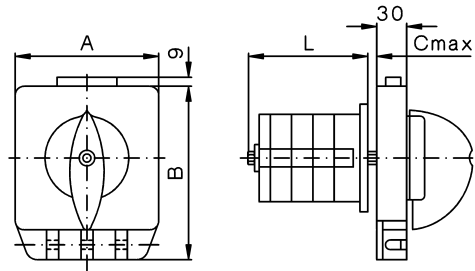

Base mounting V
N20 - N200, L100 - L1200

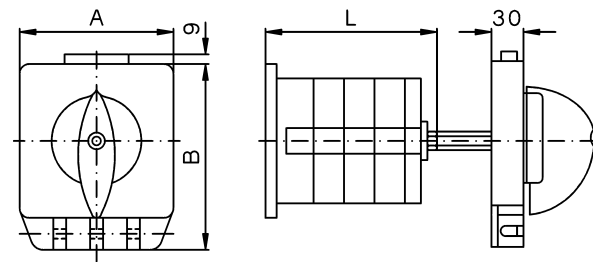

Further dimensions see page 77

Further dimensions see page 257

Type	A	B	C
N20, N33F	102	128	5
N40, N60, N80, L100, L160	102	128	7
N100, N200, L400, L600, L800, L1200	132	159	9

Padlock device SV4 (max. 3 padlocks with stirrup $\varnothing 6\text{mm}$)
M10H - N33F

Mounting holes design E, V

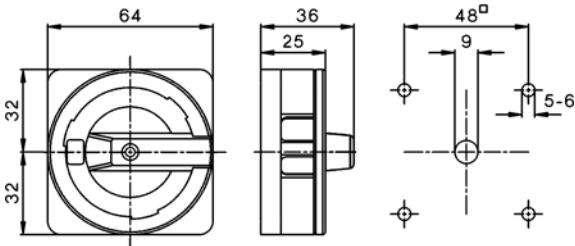

Padlock device SV4 (max. 3 padlocks with stirrup $\varnothing 6\text{mm}$)
N40 - N80, L100 - L160
Padlock device SV488
N20, N33F

Mounting holes design E, V

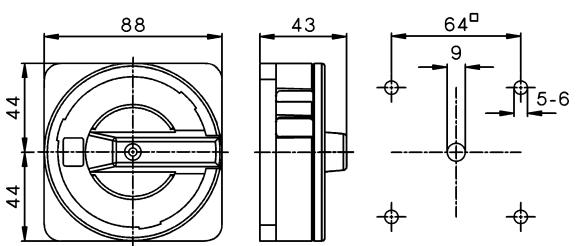

Front plate/switch shaft sealing FPWD
N20, N33F

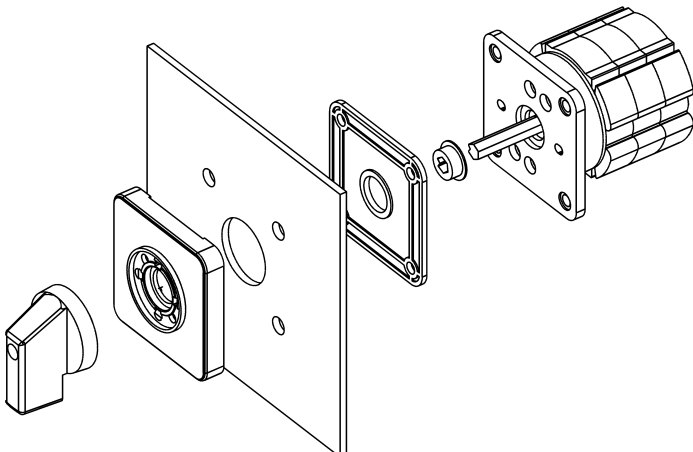

Mounting holes

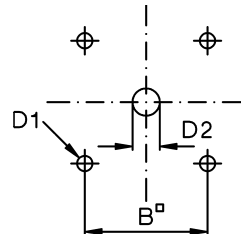

Typ	B	D1	D2
N20, N33F	48	5	17

Interlocks

Lock switch SZ, SZ2 Panel mounting E

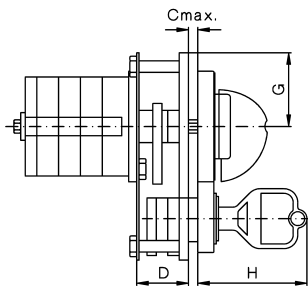
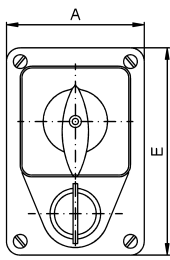

Base mounting V

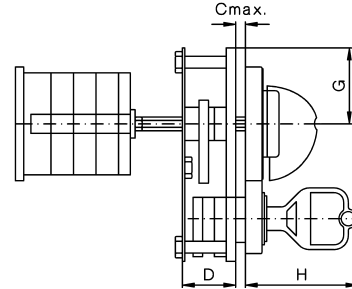
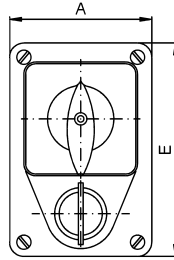

Mounting holes

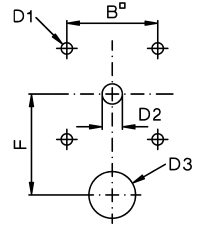

Type	A	B	C	D	D1	D2	D3	E	F	G	H
M10H, M20	60	36	3	22,5	5	8	18,5	90	40	32	47,5
N20, N33F	60	36	3	22,5	5	12	18,5	90	45	32	47,5
N40, N60, N80, L100, L160	90	68	4	24	6	12	18,5	142	61	61,5	48
N100, N200, L400, L600, L800, L1200	140	110	4	27	7	15	18,5	180	83	90,5	49

Push-button switch lock DV

Switch interlock with electrical contact ET Panel mounting E

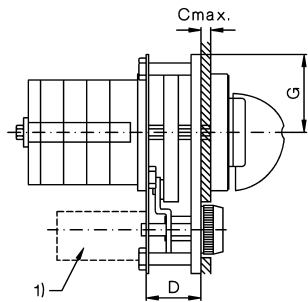
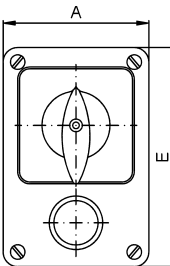

Base mounting V

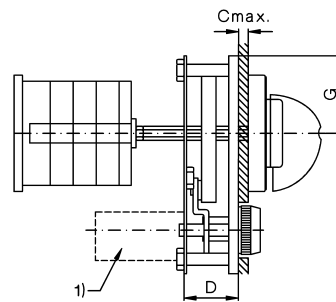
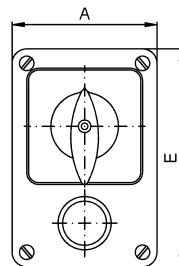

Mounting holes

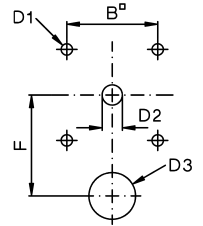

Type	A	B	C	D	D1	D2	D3	E	F	G
M10H, M20	60	36	3	22,5	5	8	26	90	40	32
N20, N33F	60	36	3	22,5	5	10	26	90	45	32
N40, N60, N80, L100, L160	90	68	4	25	6	12	29	142	61	61,5
N100, N200, L400, L600, L800, L1200	140	110	4	41	7	15	29	180	83	90,5

1) only at +ET

Moisture proofing caps for panel switches FR M10H

Type	Dimension L with .. cells						
	1	2	3	4	5	6	7
M10H	55	55	75	75	88	106	106

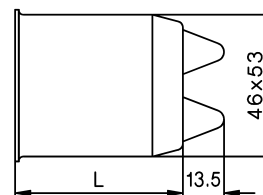
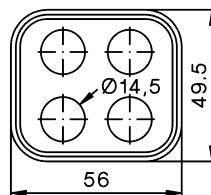

Moisture proofing caps for panel switches FR N20, N40, N60

Type	A	B	D	E	Dimension L with .. cells				
					1	2	3	4	5
N20	60	48	59	5,5	68	68	68	91	91
N40	87	68	83	5,5	82	82	117	117	-

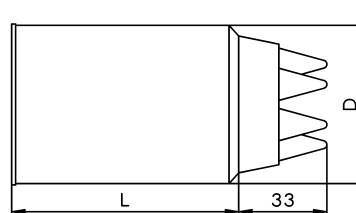
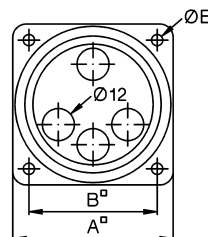

Interlocks

**Geared switch with two columns ZK2
Panel mounting E**

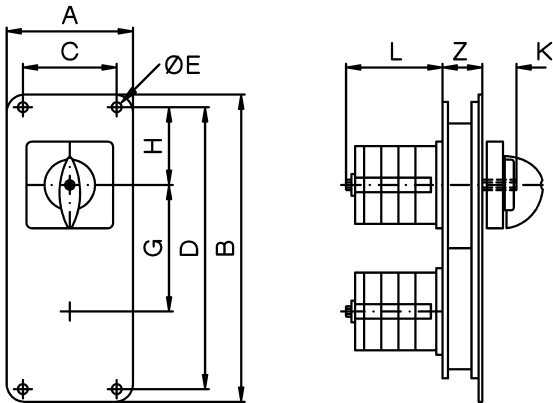

Base mounting V

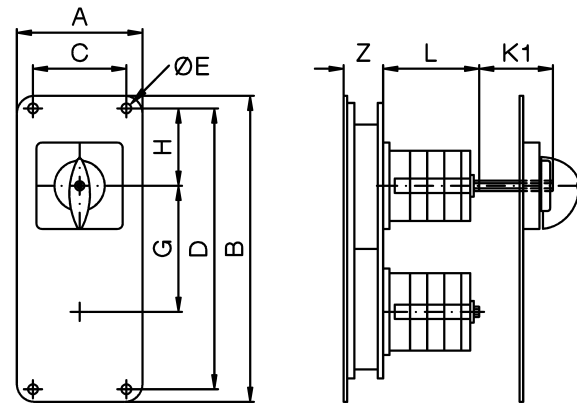

Type	A	B	C	D	E	G	H	Z
M10H, M20	70	170	52	156	5,5	70	43	22
N20, N33F	70	170	52	156	5,5	70	43	22
N40, N60, N80, L100, L160	170	190	150	168	6,5	100	43	23
N100, N200, L400, L600, L800, L1200	180	340	150	310	6,5	140	80	25

Further dimensions see pages 256 and 257

**Geared switch with tree columns ZK3
Panel mounting E**

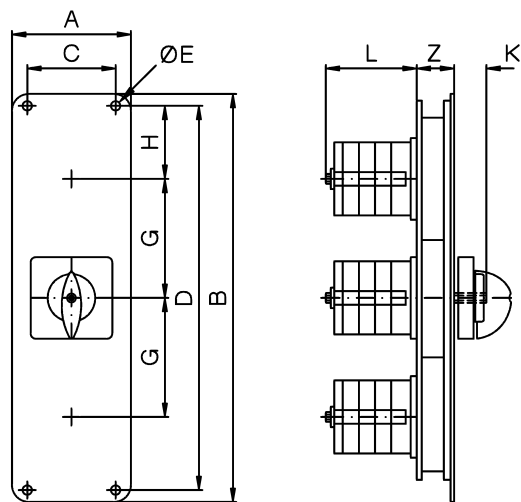

Base mounting V

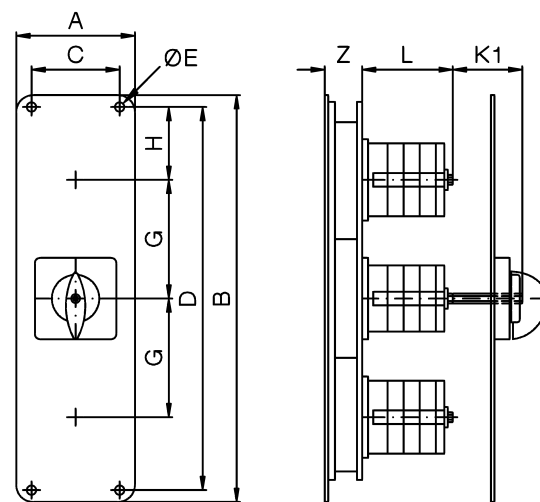

Type	A	B	C	D	E	G	H	Z
M10H, M20	70	240	52	226	5,5	70	43	22
N20, N33F	70	240	52	226	5,5	70	43	22
N40, N60, N80, L100, L160	170	290	150	269	6,5	100	43	23
N100, N200, L400, L600, L800, L1200	180	490	150	460	6,5	140	80	25

Further dimensions see pages 256 and 257

Neon safety switch N20 E .. +FEU, N33F E .. +FEU

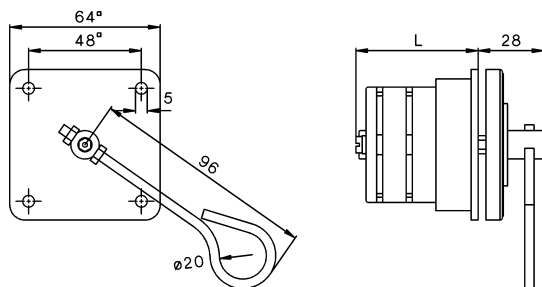

Further dimensions see pages 256

