

CLZ-FP-HD

Tubular capacitor



Description

CLZ-HD (Heavy duty) capacitor range is composed of capacitors with a tubular casing, of the dry-type, covering a wide range of power and voltage ratings, at 50 and 60 Hz. The CLZ-HD capacitors are designed to be installed in installations with extreme working conditions. The design, manufacturing and testing processes guarantee the production of top quality and long lasting capacitors. Those CLZ-HD capacitors offer a new refrigeration technology by means of nitrogen gas*, being a refrigerating system of high benefits, inert and non flammable.

Application

Its application is based on compensation in installations with static or variable loads (capacitor banks). Especially designed to be installed in roughly environments with the most extreme conditions due to its longer life and high temperature resistance.

Technical features

Electrical features	Overcurrent	1,8 times the rated current (permanently)
	Inrush current	400 x rated current
	Overvoltage	10 %, 8 over 24 hours 15 %, up to 30 minutes over 24 hours 20 %, up to 5 minutes over 24 hours 30 %, up to 1 minute over 24 hours
	Insulation level	3 / - kV
	Frequency	50 or 60 Hz
	Tolerance	-5...+10 %
	Discharge resistance	50 V / 1 minute (0,5 - 30 kvar) 75 V / 3 minutes (33 - 50 kvar)
	Losses	Dielectric: < 0,2 W / kvar Total: < 0,4 W / kvar
	Protections	Dielectric regeneration Expansion system
Mechanical features	Enclosure	Aluminium
	Power terminals	M10
	Fixing screws	M12
	Life time	≥ 150.000 hours
	Protection degree	IP 20 for CLZ-FP without terminal IP 54 for CLZ-FP with terminal (optional) (for diameters of 85,100 and 116 mm)
Environmental features	Temperature (Class D)	Daily: +45 °C Annual: +35 °C Maximum: +65 °C Minimum: -50 °C
	Humidity	95% without condensation
	Altitude	4000 m
Construction features	Type of assembly	Vertical / Horizontal
	Ventilation	Natural or forced, depending on the cabinet design
	Distance between capacitors	Minimum 2 cm
Standard	IEC 60831:2014	

* From 7.5 kvar.

Dimensions

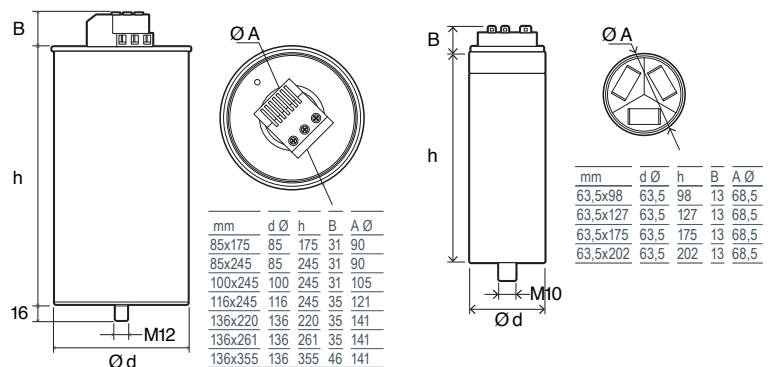

CLZ-FP-HD

Tubular capacitor

References

 $U_n = 3 \times 230 \text{ V} / 50 \text{ Hz}$

Type	Code	kvar 220 V	kvar 230 V	Hz	Dimensions (mm) (d x h)	Weight (kg)	Cover	Terminal
CLZ-FPT-23/1,25-HD	R2H511	1,15	1,25	50	63,5 x 127	0,44	-	F
CLZ-FPT-23/2,5-HD	R2H812	2,3	2,5	50	63,5 x 175	0,9	-	F
CLZ-FP-23/5-HD	R2H516	4,6	5	50	85 x 175	1,1	1	A
CLZ-FP-23/6,25-HD	R2H517	5,7	6,25	50	85 x 245	1,2	1	A
CLZ-FP-23/7,5-HD	R2H518	6,8	7,5	50	85 x 245	1,3	1	A
CLZ-FP-23/10-HD	R2H51B	9,15	10	50	100 x 245	2,0	7	A
CLZ-FP-23/12,5-HD	R2H51D	11,4	12,5	50	100 x 245	2,3	7	A
CLZ-FP-23/15-HD	R2H51E	13,75	15	50	116 x 245	2,4	2	B

 $U_n = 3 \times 440 \text{ V} / 50 \text{ Hz}$

Type	Code	kvar 400 V	kvar 440 V	Hz	Dimensions (mm) (d x h)	Weight (kg)	Cover	Terminal
CLZ-FPT-44/1,25-HD	R2H541	1	1,25	50	63,5 x 98	0,34	-	F
CLZ-FPT-44/2,5-HD	R2H542	2	2,5	50	63,5 x 127	0,44	-	F
CLZ-FPT-44/3-HD	R2H543	2,5	3	50	63,5 x 127	0,44	-	F
CLZ-FPT-44/3,75-HD	R2H544	3	3,75	50	63,5 x 127	0,44	-	F
CLZ-FPT-44/5-HD	R2H546	4	5	50	63,5 x 175	0,5	-	F
CLZ-FPT-44/6,25-HD	R2H547	5	6,25	50	63,5 x 175	0,7	-	F
CLZ-FPT-44/7,5-HD	R2H848	6,25	7,5	50	63,5 x 202	0,9	-	F
CLZ-FP-44/10-HD	R2H54B	8	10	50	85 x 245	1,1	1	A
CLZ-FP-44/12,5-HD	R2H54D	10	12,5	50	85 x 245	1,2	1	A
CLZ-FP-44/15-HD	R2H54E	12,5	15	50	85 x 245	1,4	1	A
CLZ-FP-44/18,2-HD	R2H54G	15	18,2	50	100 x 245	1,9	7	A
CLZ-FP-44/20-HD	R2H54J	16	20	50	100 x 245	2,0	7	A
CLZ-FP-44/25-HD	R2H54L	20	25	50	116 x 245	2,3	2	B
CLZ-FP-44/28-HD	R2H54M	23	28	50	116 x 245	2,4	2	B
CLZ-FP-44/30-HD	R2H54N	25	30	50	116 x 245	2,5	2	B
CLZ-FP-44/40-HD	R2H54R	32	40	50	136 x 261	3,8	-	B
CLZ-FP-44/50-HD	R2H54S	40	50	50	136 x 355	5,9	-	C

 $U_n = 3 \times 460 \text{ V} / 50 \text{ Hz}$

Type	Code	kvar 440 V	kvar 460 V	Hz	Dimensions (mm) (d x h)	Weight (kg)	Cover	Terminal
CLZ-FPT-46/6,25-HD	R2H857	5,7	6,25	50	63,5 x 127	0,7	-	F
CLZ-FP-46/12,5-HD	R2H55D	11,4	12,5	50	85 x 245	1,4	1	A
CLZ-FP-46/15-HD	R2H55E	13,7	15	50	85 x 245	1,6	1	A
CLZ-FP-46/19-HD	R2H55H	17,4	19	50	100 x 245	2,2	7	A
CLZ-FP-46/25-HD	R2H55L	22,9	25	50	116 x 245	2,5	2	B
CLZ-FP-46/30-HD	R2H55N	27,4	30	50	136 x 220	3,8	-	B

All models are inert gas filled, except for 63,5 mm diameter and 136x355 mm size

Dimensions dxh is only the tube, for total size see picture dimensions

Terminal Block: maximum cross-section type A: 16 mm², type B: 25 mm², type

C: 35 mm², F:Faston 6,3x0,8 mm and maximum current 12 A

IP 54 cover for CLZ

Cover N.	Type	Code
1	TCLZ-FP85	R29911
2	TCLZ-FP116	R29917
7	TCLZ-FP100	R29918

CLZ-FP-HD

Tubular capacitor

References

 $U_n = 3 \times 480 \text{ V} / 50 \text{ Hz}$

Type	Code	kvar 460 V	kvar 480 V	Hz	Dimensions (mm) (d x h)	Weight (kg)	Cover	Terminal
CLZ-FPT-48/2,5-HD	R2H862	2,3	2,5	50	63,5 x 127	0,9	-	F
CLZ-FPT-48/5-HD	R2H866	4,6	5	50	63,5 x 175	1,1	-	F
CLZ-FPT-48/7,5-HD	R2H868	6,9	7,5	50	63,5 x 202	1,3	-	F
CLZ-FP-48/10-HD	R2H56B	9,2	10	50	85 x 245	1,1	1	A
CLZ-FP-48/12,5-HD	R2H56D	11,5	12,5	50	85 x 245	1,3	1	A
CLZ-FP-48/15-HD	R2H56E	13,8	15	50	85 x 245	1,5	1	A
CLZ-FP-48/20-HD	R2H56J	18,4	20	50	100 x 245	2,2	7	A
CLZ-FP-48/25-HD	R2H56L	23	25	50	116 x 245	2,4	2	B
CLZ-FP-48/30-HD	R2H56N	27,6	30	50	116 x 245	2,6	2	B
CLZ-FP-48/40-HD	R2H56R	36,75	40	50	136 x 261	4,5	-	B

 $U_n = 3 \times 525 \text{ V} / 50 \text{ Hz}$

Type	Code	kvar 500 V	kvar 525 V	Hz	Dimensions (mm) (d x h)	Weight (kg)	Cover	Terminal
CLZ-FPT-52/2,5-HD	R2H872	2,3	2,5	50	63,5 x 127	0,7	-	F
CLZ-FPT-52/3-HD	R2H873	2,7	3	50	63,5 x 127	0,7	-	F
CLZ-FPT-52/4-HD	R2H875	3,6	4	50	63,5 x 175	0,7	-	F
CLZ-FPT-52/5-HD	R2H876	4,5	5	50	63,5 x 175	0,8	-	F
CLZ-FPT-52/6,25-HD	R2H877	5,7	6,25	50	63,5 x 202	0,8	-	F
CLZ-FPT-52/7,5-HD	R2H878	6,8	7,5	50	63,5 x 202	0,9	-	F
CLZ-FP-52/8-HD	R2H579	7,25	8	50	85 x 175	1,1	1	A
CLZ-FP-52/10-HD	R2H57B	9,1	10	50	85 x 245	1,2	1	A
CLZ-FP-52/12,5-HD	R2H57D	11,3	12,5	50	85 x 245	1,4	1	A
CLZ-FP-52/15-HD	R2H57E	13,6	15	50	85 x 245	1,5	1	A
CLZ-FP-52/20-HD	R2H57J	18,15	20	50	100 x 245	2,3	7	A
CLZ-FP-52/25-HD	R2H57L	22,7	25	50	116 x 245	2,5	2	B
CLZ-FP-52/30-HD	R2H57N	27,2	30	50	116 x 245	3,1	2	B
CLZ-FP-52/40-HD	R2H57R	36,3	40	50	136 x 261	3,2	-	B
CLZ-FP-52/50-HD	R2H57S	45,4	50	50	136 x 355	5,9	-	C

 $U_n = 3 \times 690 \text{ V} / 50 \text{ Hz}$

Type	Code	kvar 660 V	kvar 690 V	Hz	Dimensions (mm) (d x h)	Weight (kg)	Cover	Terminal
CLZ-FPT-69/2,5-HD	R2H892	2,3	2,5	50	63,5 x 127	0,7	-	F
CLZ-FPT-69/5-HD	R2H896	4,6	5	50	63,5 x 175	0,8	-	F
CLZ-FP-69/7,5-HD	R2H598	6,9	7,5	50	85 x 175	1,1	1	A
CLZ-FP-69/10-HD	R2H59B	9,15	10	50	85 x 245	1,2	1	A
CLZ-FP-69/12,5-HD	R2H59D	11,4	12,5	50	85 x 245	1,4	1	A
CLZ-FP-69/15-HD	R2H59E	13,7	15	50	85 x 245	1,6	1	A
CLZ-FP-69/20-HD	R2H59J	18,3	20	50	100 x 245	2,4	7	A
CLZ-FP-69/25-HD	R2H59L	22,9	25	50	116 x 245	2,5	2	B
CLZ-FP-69/30-HD	R2H59N	27,5	30	50	136 x 220	3,8	-	B
CLZ-FP-69/40-HD	R2H59R	36,6	40	50	136 x 355	5,9	-	C
CLZ-FP-69/50-HD	R2H59S	45,75	50	50	136 x 355	5,9	-	C

All models are inert gas filled, except for 63,5 mm diameter and 136x355 mm size

Dimensions dxh is only the tube, for total size see picture dimensions

Terminal Block: maximum cross-section type A: 16 mm², type B: 25 mm², type C: 35 mm², F:Faston 6,3x0,8 mm and maximum current 12 A

IP 54 cover for CLZ

Cover N.	Type	Code
1	TCLZ-FP85	R29911
2	TCLZ-FP116	R29917
7	TCLZ-FP100	R29918

CLZ-FP-HD

Tubular capacitor

References

 $U_n = 3 \times 240 \text{ V} / 60 \text{ Hz}$

Type	Code	kvar 230 V	kvar 240 V	Hz	Dimensions (mm) (d x h)	Weight (kg)	Cover	Terminal
CLZ-FPT-24/2,5-60Hz-HD	R2H622	2,3	2,5	60	63,5 x 127	0,44	-	F
CLZ-FP-24/5-60Hz-HD	R2H626	4,6	5	60	85 x 175	1,0	1	A
CLZ-FP-24/6,25-60Hz-HD	R2H627	5,75	6,25	60	85 x 175	1,1	1	A
CLZ-FP-24/7,5-60Hz-HD	R2H628	6,9	7,5	60	85 x 245	1,1	1	A
CLZ-FP-24/10-60Hz-HD	R2H62B	9,2	10	60	85 x 245	1,1	1	A
CLZ-FP-24/12,5-60Hz-HD	R2H62D	11,5	12,5	60	85 x 245	1,6	1	A
CLZ-FP-24/15-60Hz-HD	R2H62E	13,8	15	60	100 x 245	2,1	7	A

 $U_n = 3 \times 440 \text{ V} / 60 \text{ Hz}$

Type	Code	kvar 400 V	kvar 440 V	Hz	Dimensions (mm) (d x h)	Weight (kg)	Cover	Terminal
CLZ-FPT-44/1,25-60Hz-HD	R2H641	1	1,25	60	63,5 x 98	0,34	-	F
CLZ-FPT-44/2,5-60Hz-HD	R2H642	2,1	2,5	60	63,5 x 127	0,44	-	F
CLZ-FPT-44/3-60Hz-HD	R2H643	2,5	3	60	63,5 x 127	0,44	-	F
CLZ-FPT-44/3,75-60Hz-HD	R2H644	3,1	3,75	60	63,5 x 127	0,44	-	F
CLZ-FPT-44/5-60Hz-HD	R2H646	4,15	5	60	63,5 x 127	0,44	-	F
CLZ-FP-44/6,25-60Hz-HD	R2H647	5,2	6,25	60	85 x 175	0,8	1	A
CLZ-FP-44/7,5-60Hz-HD	R2H648	6,2	7,5	60	85 x 175	0,9	1	A
CLZ-FP-44/10-60Hz-HD	R2H64B	8,3	10	60	85 x 175	1,0	1	A
CLZ-FP-44/12,5-60Hz-HD	R2H64D	10,3	12,5	60	85 x 245	1,1	1	A
CLZ-FP-44/15-60Hz-HD	R2H64E	12,4	15	60	85 x 245	1,2	1	A
CLZ-FP-44/20-60Hz-HD	R2H64J	16,5	20	60	85 x 245	1,5	1	A
CLZ-FP-44/25-60Hz-HD	R2H64L	20,7	25	60	100 x 245	2,0	7	A
CLZ-FP-44/30-60Hz-HD	R2H64N	24,8	30	60	116 x 245	2,3	2	B
CLZ-FP-44/40-60Hz-HD	R2H64R	33,1	40	60	136 x 220	2,8	2	B
CLZ-FP-44/50-60Hz-HD	R2H64S	41,3	50	60	136 x 355	5,6	-	C

 $U_n = 3 \times 480 \text{ V} / 60 \text{ Hz}$

Type	Code	kvar 460 V	kvar 480 V	Hz	Dimensions (mm) (d x h)	Weight (kg)	Cover	Terminal
CLZ-FPT-48/2,5-60Hz-HD	R2H762	2,3	2,5	60	63,5 x 127	0,8	-	F
CLZ-FPT-48/5-60Hz-HD	R2H766	4,6	5	60	63,5 x 175	0,8	-	F
CLZ-FPT-48/6,25-60Hz-HD	R2H767	5,75	6,25	60	63,5 x 175	0,9	-	F
CLZ-FPT-48/7,5-60Hz-HD	R2H768	6,9	7,5	60	63,5 x 175	0,9	-	F
CLZ-FP-48/10-60Hz-HD	R2H66B	9,2	10	60	85 x 175	1,1	1	A
CLZ-FP-48/12,5-60Hz-HD	R2H66D	11,5	12,5	60	85 x 245	1,2	1	A
CLZ-FP-48/15-60Hz-HD	R2H66E	13,8	15	60	85 x 245	1,3	1	A
CLZ-FP-48/20-60Hz-HD	R2H66J	18,4	20	60	100 x 245	1,9	7	A
CLZ-FP-48/25-60Hz-HD	R2H66L	23	25	60	100 x 245	2,2	2	B
CLZ-FP-48/30-60Hz-HD	R2H66N	27,6	30	60	116 x 245	2,4	2	B
CLZ-FP-48/40-60Hz-HD	R2H66R	36,75	40	60	136 x 220	3,8	-	B
CLZ-FP-48/50-60Hz-HD	R2H66S	46	50	60	136 x 355	5,9	-	C

All models are inert gas filled, except for 63,5 mm diameter and 136x355 mm size

Dimensions dxh is only the tube, for total size see picture dimensions

Terminal Block: maximum cross-section type A: 16 mm², type B: 25 mm²,

type C: 35 mm², F:Faston 6,3x0,8 mm and maximum current 12 A

IP 54 cover for CLZ

Cover N.	Type	Code
1	TCLZ-FP85	R29911
2	TCLZ-FP116	R29917
7	TCLZ-FP100	R29918

CLZ-FP-HD

Tubular capacitor

References

 $U_N = 3 \times 525 \text{ V} / 60 \text{ Hz}$

Type	Code	kvar 480 V	kvar 525 V	Hz	Dimensions (mm) (d x h)	Weight (kg)	Cover	Terminal
CLZ-FPT-52/2,5-60Hz-HD	R2H772	2,1	2,5	60	63,5 x 127	0,8	-	F
CLZ-FPT-52/5-60Hz-HD	R2H776	4,2	5	60	63,5 x 175	0,9	-	F
CLZ-FPT-52/6,25-60Hz-HD	R2H777	5,2	6,25	60	63,5 x 175	1,1	-	F
CLZ-FPT-52/7,5-60Hz-HD	R2H778	6,25	7,5	60	63,5 x 202	1,3	-	F
CLZ-FP-52/8,5-60Hz-HD	R2H67A	7,1	8,5	60	85 x 175	1,0	1	A
CLZ-FP-52/10-60Hz-HD	R2H67B	8,4	10	60	85 x 175	1,1	1	A
CLZ-FP-52/11,5-60Hz-HD	R2H67C	9,6	11,5	60	85 x 245	1,2	1	A
CLZ-FP-52/12,5-60Hz-HD	R2H67D	10,5	12,5	60	85 x 245	1,2	1	A
CLZ-FP-52/15-60Hz-HD	R2H67E	12,5	15	60	85 x 245	1,4	1	A
CLZ-FP-52/17-60Hz-HD	R2H67I	14,2	17	60	85 x 245	1,5	1	A
CLZ-FP-52/20-60Hz-HD	R2H67J	16,7	20	60	100 x 245	2,0	7	A
CLZ-FP-52/22,5-60Hz-HD	R2H67K	18,8	22,5	60	100 x 245	2,2	7	A
CLZ-FP-52/25-60Hz-HD	R2H67L	20,9	25	60	100 x 245	2,4	7	A
CLZ-FP-52/30-60Hz-HD	R2H67N	25	30	60	116 x 245	2,5	2	B
CLZ-FP-52/34-60Hz-HD	R2H67P	28,4	34	60	116 x 245	2,6	2	B
CLZ-FP-52/40-60Hz-HD	R2H67R	33,4	40	60	136 x 261	3,8	-	B

 $U_n = 3 \times 600 \text{ V} / 60 \text{ Hz}$

Type	Code	kvar 600 V	Hz	Dimensions (mm) (d x h)	Weight (kg)	Cover	Terminal
CLZ-FPT-60/2,5-60Hz-HD	R2H782	2,5	60	63,5 x 127	0,7	-	F
CLZ-FPT-60/5-60Hz-HD	R2H786	5	60	63,5 x 175	0,8	-	F
CLZ-FPT-60/6,25-60Hz-HD	R2H787	6,25	60	63,5 x 175	0,9	-	F
CLZ-FPT-60/7,5-60Hz-HD	R2H788	7,5	60	63,5 x 175	1,0	-	F
CLZ-FP-60/10-60Hz-HD	R2H68A	10	60	85 x 175	1,1	1	A
CLZ-FP-60/12,5-60Hz-HD	R2H68B	12,5	60	85 x 245	1,2	1	A
CLZ-FP-60/15-60Hz-HD	R2H68E	15	60	85 x 245	1,3	1	A
CLZ-FP-60/17,5-60Hz-HD	R2H68I	17,5	60	85 x 245	1,4	1	A
CLZ-FP-60/20-60Hz-HD	R2H68J	20	60	100 x 245	1,9	7	A
CLZ-FP-60/21-60Hz-HD	R2H68K	21	60	100 x 245	2,0	7	A
CLZ-FP-60/25-60Hz-HD	R2H68L	25	60	100 x 245	2,2	7	A
CLZ-FP-60/30-60Hz-HD	R2H68N	30	60	116 x 245	2,4	2	B
CLZ-FP-60/34,5-60Hz-HD	R2H68P	34,5	60	116 x 245	2,6	2	B

 $U_n = 3 \times 690 \text{ V} / 60 \text{ Hz}$

Type	Code	kvar 660 V	kvar 690 V	Hz	Dimensions (mm) (d x h)	Weight (kg)	Cover	Terminal
CLZ-FPT-69/2,5-60Hz-HD	R2H792	2,3	2,5	60	63,5 x 127	0,9	-	F
CLZ-FPT-69/5-60Hz-HD	R2H796	4,6	5	60	63,5 x 175	1,0	-	F
CLZ-FPT-69/7,5-60Hz-HD	R2H798	6,9	7,5	60	63,5 x 202	1,1	-	F
CLZ-FP-69/10-60Hz-HD	R2H69B	9,15	10	60	85 x 245	1,1	1	A
CLZ-FP-69/12,5-60Hz-HD	R2H69D	11,4	12,5	60	85 x 245	1,2	1	A
CLZ-FP-69/15-60Hz-HD	R2H69E	13,7	15	60	85 x 245	1,4	1	A
CLZ-FP-69/20-60Hz-HD	R2H69J	18,3	20	60	100 x 245	2,0	7	A
CLZ-FP-69/25-60Hz-HD	R2H69L	22,9	25	60	116 x 245	2,3	2	B
CLZ-FP-69/30-60Hz-HD	R2H69N	27,5	30	60	116 x 245	2,5	2	B
CLZ-FP-69/40-60Hz-HD	R2H69R	36,6	40	60	136 x 220	3,8	-	B
CLZ-FP-69/50-60Hz-HD	R2H69S	45,75	50	60	136 x 355	5,9	-	C

All models are inert gas filled, except for 63,5 mm diameter and 136x355 mm size

Dimensions dxh is only the tube, for total size see picture dimensions

Terminal Block: maximum cross-section type A: 16 mm², type B: 25 mm²,type C: 35 mm², F:Faston 6,3x0,8 mm and maximum current 12 A

IP 54 cover for CLZ

Cover N.	Type	Code
1	TCLZ-FP85	R29911
2	TCLZ-FP116	R29917
7	TCLZ-FP100	R29918