





SIMPLEX VALVE TYPE MINI TRI-CLAMP/H EPDM



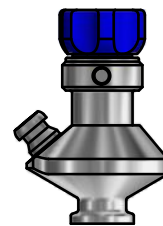

ART. NO. 832141EPDM

GENERAL

-  The KEOFITT SIMPLEX Sampling Valve is our CIP-able sampling valve for less demanding applications. Replaces non-hygienic sampling cocks. More than 20 different configurations available. Unique serial no. for each valve*.
-  The sampling valve can be used for any process sampling for chemical and/or physical analysis.
-  Cleaning: Valve in open position: Cleanable by means of CIP using the detergent solution suitable for the actual process media. For further advice, please contact Keofitt. Not recommended for autoclave due to plastic parts.
-  Designed for sampling of liquids with a viscosity of up to approx. 1.000 cP containing no particles larger than Ø3 mm. Sampling of more viscous liquids is possible, only will it take longer (depending on process pressure).



FEATURES

-  Installation: Mini Tri-Clamp
DIN 32676:2009-05 Table 4 Row C
-  Operation: Turn knob - spring loaded (opens counterclockwise)
-  Head assembly: Hand tight using a tommy bar or maximum 15 Nm. Tommy bar included (#900118).
-  Outlet: Hose piece
-  Membrane: EPDM (#600052)

CERTIFICATION*

- EU EC 1935/2004 · EU EC 2023/2006 · DK No.822 06/2013 · 3-A Certificate · 3.1 Material Certificate · Ra Certificate
- ATEX 94/9/EC & 2014/34/EU · PED 2014/68/EU · FDA CFR 21 §177.2600 · USP Class VI · EHEDG (2008) · Keofitt DoC

TECHNICAL DATA

Material (product contact)

- Steel parts AISI 316L (1.4404)
- Membrane EPDM, BLACK (#600052)

Material (without product contact)

- Steel parts AISI 303 (1.4305) / AISI 316L (1.4404)
- Knob PA6 (Blue)

Membrane

- Article EPDM, BLACK (#600052)
- Certification* · EU EC 1935/2004 · EU EC 2023/2006
- DK No.822 06/2013 · FDA CFR 21 §177.2600 · USP Class VI
- REACH · RoHS · ADI Free · Keofitt DoC

Surface Treatment

- Outside Electropolished Ra ≤ 1.2 µm
- Inside (wetted surface) Electropolished Ra ≤ 0.5 µm
- Process connection Electropolished Ra ≤ 0.5 µm

Pressure & Temperature

- Pressure 0 - 10 bar / 0 - 145 psi
- Temperature 1 - 130°C / 34 - 266°F
- Air supply -

Net Weight

- kg/lbs 0.487 kg/1.072 lbs

Spareparts

- 778301EPDM PARTS FOR SIMPLEX 01E/05E/11E/21E/22E

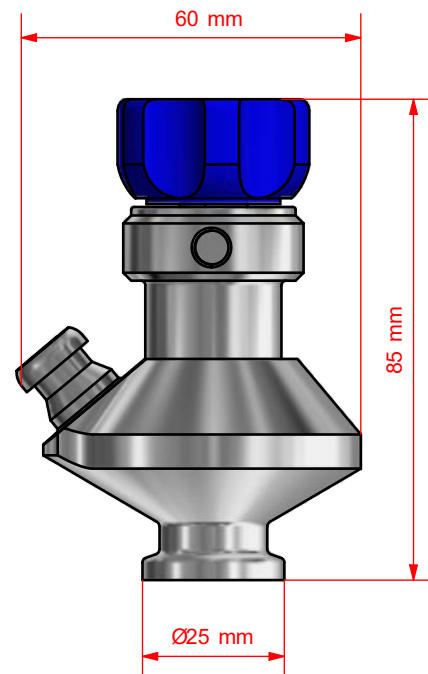
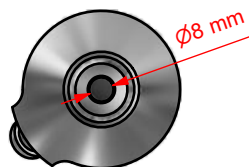
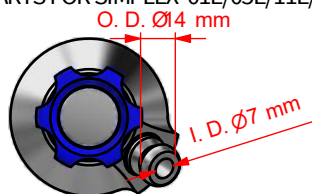

*For further information and download please visit www.keofitt.dk

KEOFITT SIMPLEX™ SAMPLING VALVES

		MANUAL VALVE					Ø68 VARIVENT			
		TANK WELDING	PIPE WELDING	MINI CLAMP	1" & 1½" CLAMP	2" CLAMP				
HOSE PIECE	SILICONE	830141	831141	832141	832241	830541	830941			
	EPDM	830141.2EPDM	831141.2EPDM	832141.2EPDM	832241.2EPDM	830541.2EPDM	830941.2EPDM			
	PTFE	830141.2PTFE	831141.2PTFE	832141.2PTFE	832241.2PTFE	830541.2PTFE	830941.2PTFE			
WELDING LINER	SILICONE	830141.2	831141.2							
	EPDM	830141.2EPDM	831141.2EPDM							
	PTFE	830141.2PTFE	831141.2PTFE							

		PNEUMATIC VALVE						Ø68 VARIVENT		
		TANK WELDING	PIPE WELDING	MINI CLAMP	1" & 1½" CLAMP	2" CLAMP				
HOSE PIECE	SILICONE	830144	831144	832144	832244	830544	830944			
	EPDM	830144.2EPDM	831144.2EPDM	832144.2EPDM	832244.2EPDM	830544.2EPDM	830944.2EPDM			
	PTFE	830144.2PTFE	831144.2PTFE	832144.2PTFE	832244.2PTFE	830544.2PTFE	830944.2PTFE			
WELDING LINER	SILICONE	830144.2	831144.2							
	EPDM	830144.2EPDM	831144.2EPDM							
	PTFE	830144.2PTFE	831144.2PTFE							

