





VALVE BODY M4 TYPE P





ART. NO. 400011

GENERAL

-  The KEOFITT CLASSIC M4 Sampling Valve is the smallest KEOFITT sampling valve. Used in all industries for decades. More than 120 standard valve configurations. Unique serial no. for each valve*.
-  The sampling valve can be used for any process sampling for microbiological, chemical and/or physical analysis.
-  **Cleaning/sterilizing:** Between batches: Valve in open position: Cleanable by means of CIP using the detergent solution suitable for the actual process media. Between samples: Valve in its normal closed position: cleanable by CIP as "Between batches" or the valve may be sterilized by means of steam SIP or chemical SIP using a procedure appropriate to the actual circumstances. For further advice, please contact Keofitt.
-  Designed for sampling of liquids with a viscosity of up to approx. 100 cP containing no particles larger than Ø1.5 mm. Sampling of more viscous liquids is possible, only will it take longer (depending on process pressure).



FEATURES

-  Installation: Pipe welding: DIN EN ISO 1127 25x1.25
-  Operation: Depending on choice of valve head
-  Inlet / Outlet: Hose piece
-  Membrane: Depending on choice of valve head

CERTIFICATION*

- EU EC 1935/2004 · EU EC 2023/2006 · DK No.822 06/2013 · 3-A Certificate · 3.1 Material Certificate · Ra Certificate
- ATEX 94/9/EC & 2014/34/EU · PED 2014/68/EU · EHEDG (2007) · Keofitt DoC

TECHNICAL DATA

Material (product contact)

- Steel parts AISI 316L (1.4404)

Material (without product contact)

- Steel parts AISI 316L (1.4404)
- Rubber cap EPDM (black)
- Stainless steel chain AISI 316L (1.4404)

Surface Treatment

- Outside Electropolished Ra ≤ 1.2 µm
- Inside (wetted surface) Electropolished Ra ≤ 0.5 µm
- Process connection Electropolished Ra ≤ 0.5 µm

Pressure & Temperature

- Pressure Depending on choice of valve head
- Temperature Depending on choice of valve head
- Air supply Depending on choice of valve head

Net Weight

- kg/lbs 0.129 kg/0.283 lbs





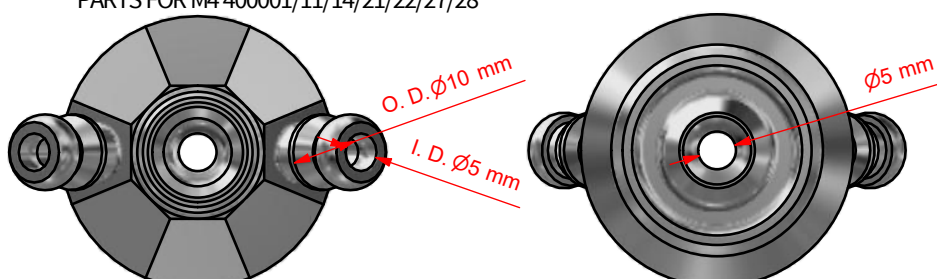
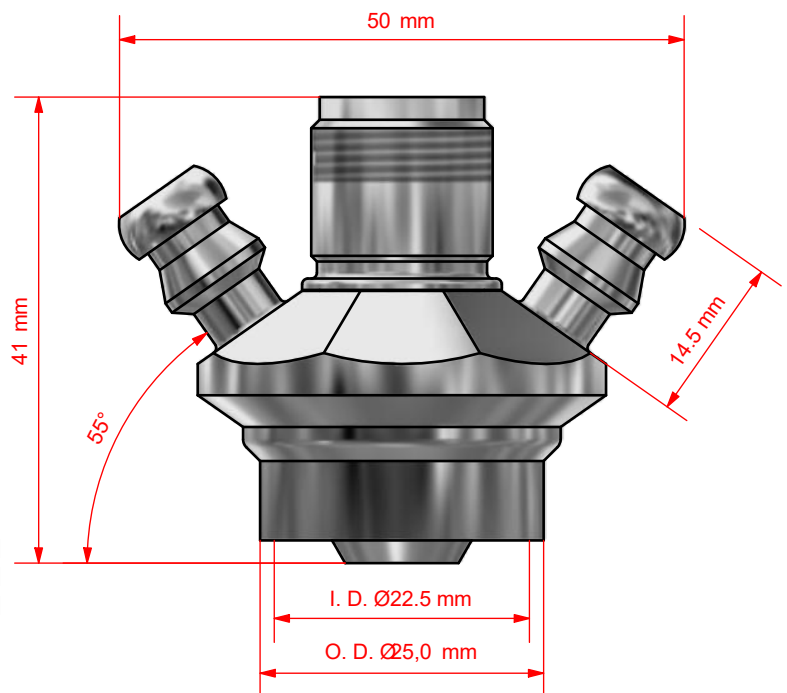



Spareparts

- 774001 PARTS FOR M4 400001/11/14/21/22/27/28











*For further information and download please visit www.keofitt.dk

KEOFITT CLASSIC M4 SAMPLING VALVE - HEADS

M4 HEADS			
SILICONE	<p>TYPE H TURN KNOB 0-10 BAR (G)</p>  <p>400041</p>	<p>TYPE K KEY RING 0-10 BAR (G)</p>  <p>400042</p>	<p>TYPE O LEVER HANDLE 0-10 BAR (G)</p>  <p>400043</p>
EPDM	 <p>400041E</p>	 <p>400042E</p>	 <p>400043E</p>
PTFE	 <p>405541</p>	 <p>405542</p>	 <p>405543</p>

> 18 <

< 17 >

<p>TYPE N PNEUMATIC 0-10 BAR (G)</p>  <p>400044</p>	<p>TYPE N PNEUMATIC, ADJUSTABLE 0-10 BAR (G)</p>  <p>400045</p>	<p>TYPE B NO SPRING 0-12 BAR (G)</p>  <p>400047</p>
 <p>400044E</p>	 <p>400045E</p>	 <p>400047E</p>
 <p>405544</p>	 <p>405545</p>	 <p>405547</p>

> 19 <

< 18 >

