

AR、BR Series



Symbol



Product feature

1. The structure is delicate and compact, which is convenient for installation and application.
2. The pressed-in self-locking mechanism can prevent the abnormal movement of the set pressure caused by external interfere.
3. In addition to standard type, lower pressure type is optional (The highest adjustable pressure is 0.4MPa).

Specification

Model	Ar1500	AR2000	BR2000	BR3000	BR4000
Fluid	Air				
Port size	1/8"	1/4"	1/4"	3/8"	1/2"
Pressure range	0.05~0.9MPa(7~130Psi)				
Max. pressure	1.0MPa(145Psi)				
Proof pressure	1.5MPa(215Psi)				
Temperature range	-20~70°C				
Weight	200g		230g		

① PT thread, G thread and NPT thread are available.

Ordering code

AR 2000 L **1**

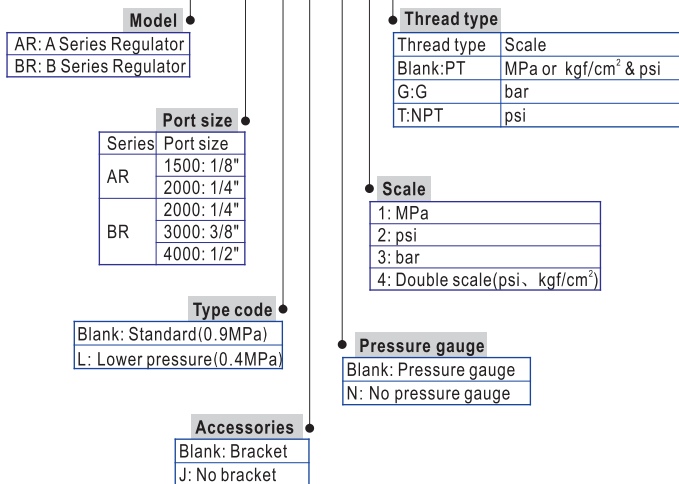

Pressure and feature of flow

Pressure chart

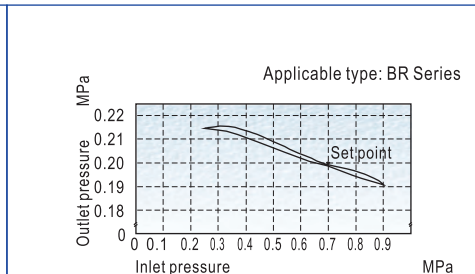
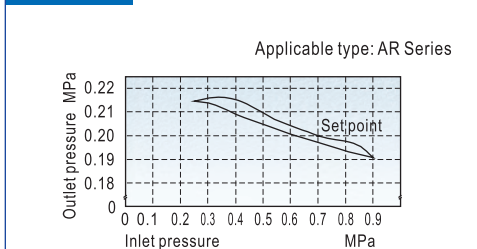

Flow chart

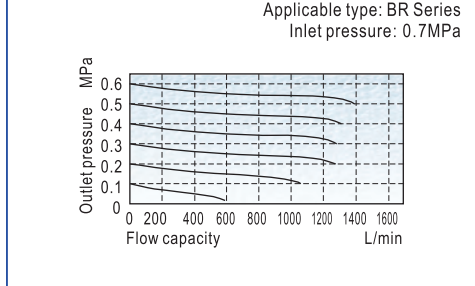
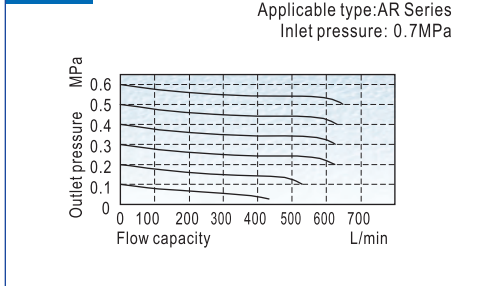

AR
BR

Preparation unit—Regulator

AR, BR Series

Inner structure and material of major parts

Dimensions

AR

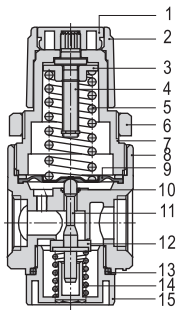

BR

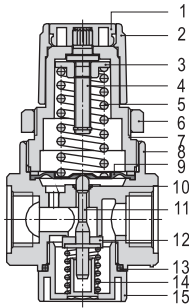

No.	Item	Material
1	Push button	POM
2	Adjusting button	POM
3	Adjusting nut	Steel
4	Adjusting pillar	Steel
5	Adjusting spring	SWC
6	Fixed ring	POM
7	Adjusting seat	POM
8	Body	Aluminum alloy
9	Diaphragm	SUS304 & rubber
10	Needle O-ring	NBR
11	Balance needle	POM
12	Needle gasket	Aluminum alloy & rubber
13	Cap O-ring	NBR
14	Return spring	Stainless steel
15	Regulator cap	POM

AR

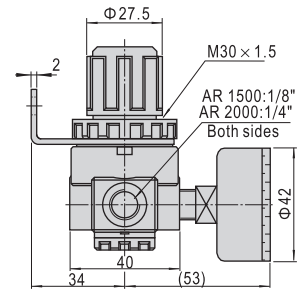
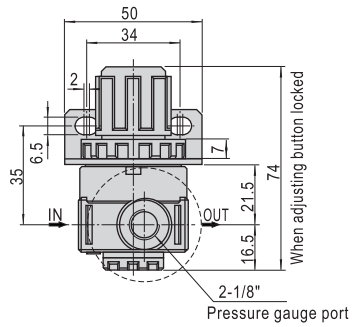

BR

