

PT025R-29-LI3-H1140

Pressure Transmitter, Front-Flush – With Current Output (2-Wire)

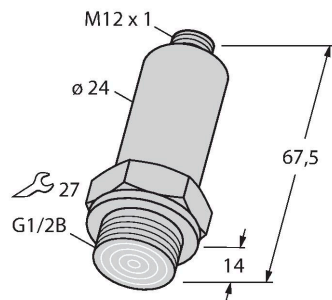

Features

- Compact and robust design
- Pressure connection with front-flush mounted stainless steel diaphragm
- Accuracy hardly affected by temperature within entire range
- Excellent EMC properties
- Pressure range 0...25 bar rel.

Wiring diagram

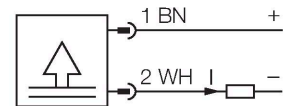

Functional principle

The pressure sensors of the PT ...-2 series operate with a thin-film measuring cell. The thin-film sensor is welded directly to the pressure connection, just like the housing. The processed signal is made available as analog output of 4...20 mA (2-wire).

Technical data

Type	PT025R-29-LI3-H1140
ID	6831556
Medium temperature	-25...+85 °C
Pressure range	
Pressure type	Relative pressure
Pressure range	0...25 bar
	0...362.6 psi
	0...2.5 MPa
Admissible overpressure	≤ 40 bar
Burst pressure	≥ 120 bar
Response time	1 ms
Power supply	
Operating voltage	9...30 VDC
Current consumption	≤ 4 mA
Protective measure	SELV according to EN 50178
Short-circuit/reverse polarity protection	yes / yes
Insulation class	III
Outputs	
Output 1	Analog output
Output function	Analog output current
Analog output	
Current output	4...20 mA
Load	≤ 1.2 kΩ
Accuracy LHR	± 0.5 % FS BSL
Housing material	Stainless steel, 1.4435 (AISI 316L)

Technical data

Process connection	G 1/2" front-flush
Pressure connection material	Stainless steel 1.4435 (AISI 316L)
Pressure transducer material	Stainless steel 1.4548 (AISI 630)
Wrench size pressure connection / coupling nut	SW27
Electrical connection	Connector, M12 × 1
Protection class	IP67
Ambient temperature	-25...+85 °C
Storage temperature	-25...+85 °C
Shock resistance	30 g (11 ms) , acc. to IEC 68-2-27
Vibration resistance	3 x g (5-500-5 Hz, 10 cycles per axis, 1 oct/min), acc. to IEC 68-2-6
Reference conditions acc. to IEC 61298-1	
Temperature	15...+25 °C
Atmospheric pressure	860...1060 hPa abs.
Humidity	45...75 % rel.
Auxiliary power	24 VDC
Temperature behaviour	
Temperature coefficient span T_{ks}	± 0.3 % of full scale/10 K
Temperature coefficient zero point T_{k0}	± 0.3 % of full scale/10 K
MTTF	acc. to SN 29500 (Ed. 99) 40 °C
Technical data	
Type	PT025R-29-LI3-H1140
ID	6831556
Pressure range	
Pressure type	Relative pressure
Pressure range	0...25 bar
	0...362.6 psi
	0...2.5 MPa
Admissible overpressure	≤ 40 bar
Burst pressure	≥ 120 bar
Response time	1 ms
Power supply	
Operating voltage	9...30 VDC
Current consumption	≤ 4 mA
Protective measure	SELV according to EN 50178
Short-circuit/reverse polarity protection	yes / yes
Protection type and class	IP67 / III
Outputs	
Output 1	Analog output

Technical data

Output function	Analog output current
Analog output	
Current output	4...20 mA
Load	≤ 1.2 kΩ
Accuracy LHR	± 0.5 % FS BSL
Temperature behaviour	
Medium temperature	-25...+85 °C
Temperature coefficient zero point T _{k0}	± 0.3 % of full scale/10 K
Temperature coefficient span T _{ks}	± 0.3 % of full scale/10 K
Ambient conditions	
Ambient temperature	-25...+85 °C
Storage temperature	-25...+85 °C
Vibration resistance	3 x g (5-500-5 Hz, 10 cycles per axis, 1 oct/min), acc. to IEC 68-2-6
Shock resistance	30 g (11 ms) , acc. to IEC 68-2-27
Mechanical data	
Housing material	Stainless steel, 1.4435 (AISI 316L)
Pressure connection material	Stainless steel 1.4435 (AISI 316L)
Pressure transducer material	Stainless steel 1.4548 (AISI 630)
Process connection	G 1/2" front-flush
Wrench size pressure connection / coupling nut	SW27
Electrical connection	Connector, M12 × 1
Reference conditions acc. to IEC 61298-1	
Temperature	15...+25 °C
Atmospheric pressure	860...1060 hPa abs.
Humidity	45...75 % rel.
Auxiliary power	24 VDC
MTTF	acc. to SN 29500 (Ed. 99) 40 °C

Accessories

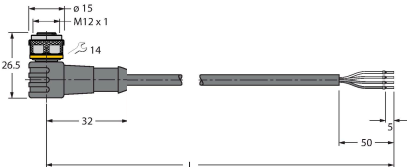
Dimension drawing	Type	ID	
	WKC4.4T-2/TEL	6625025	Connection cable, female M12, angled, 4-pin, cable length: 2 m, sheath material: PVC, black; cULus approval; other cable lengths and qualities available, see www.turck.com

Dimension drawing	Type	ID	
	RKC4.4T-2/TEL	6625013	Connection cable, female M12, straight, 4-pin, cable length: 2 m, sheath material: PVC, black; cULus approval; other cable lengths and qualities available, see www.turck.com
	RKC4.4T-2/TXL	6625503	Connection cable, female M12, straight, 4-pin, cable length: 2 m, sheath material: PUR, black; cULus approval; other cable lengths and qualities available, see www.turck.com
	WKC4.4T-2/TXL	6625515	Connection cable, female M12, angled, 4-pin, cable length: 2 m, sheath material: PUR, black; cULus approval; other cable lengths and qualities available, see www.turck.com
	RKC4.4T-P7X2-10/TXL	6626184	Connection cable, female M12, angled, 4-pin, cable length: 10m, sheath material: PUR, black; cULus approval; other cable lengths and qualities available, see www.turck.com