

E45--C Series, 1/2", 5/2 or 5/3 Function Solenoid Valve

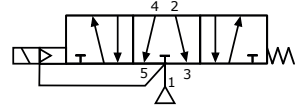
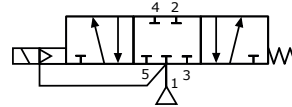
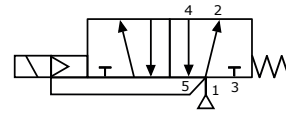

DESCRIPTION

Pilot operated solenoid valve.

Hazardous area approved pilot operators (ExnA, Exm, Exme, Exd and Exia) are available with various international approvals – ATEX, IECEx, FM, GOST CU TR (Russia) and NEPSI (China).

Body material available in

- Aluminium (standard)
- Stainless Steel
- Brass

Seal kit available – VSK501

FEATURES

- Internal or external pilot air connection
- Interchangeable CNOMO interface coils, including various hazardous area options
- Single coil spring return function or double coil stay put function
- Convenient fixing holes to enable bracket mounting
- Pilot exhaust dust caps fitted as standard

PRODUCT CODE: E 4 5 C 0

OPERATOR COIL VOLTAGE OPTIONS 2

DESIGNATOR

SEE BELOW FOR PRODUCT CODE DETAILS

Any of the below options that are not required enter '0' in relevant box.

Operator

- 1 8** Spring return, internal pilot air feed
- 8 0** Spring return, external pilot air connection
- 1 9** Double solenoid, internal pilot air feed
- 9 0** Double solenoid, external pilot air connection
- 1 4** 5/3 All ports sealed mid position, internal pilot air feed
- 4 0** 5/3 All ports sealed mid position, external pilot air connection
- 1 5** 5/3 Inlet sealed open exhaust mid position, internal pilot air feed
- 5 0** 5/3 Inlet sealed open exhaust mid position, external pilot air connection

Coil

- A** Exia (BASEEFA)
- B** Terminal Box
- D** Exd
- H** Plug & Socket Exia
- K** MC30 Plug & Socket
- L** MC30 Plug & Socket with LED
- N** ExnA
- P** Plug & Socket
- S** Exia (BASEEFA) Stainless Steel Housing
- T** Inline Terminal Box
- U** Exia (FM)
- 0** No Coil Unit
- 9** Exm

Options 1

- C** Lever manual override
- D** Push button manual override
- S** Screw driver override (standard)
- 0** No option required

Standard Voltage

- B** 24v DC
- H** 24v DC Low Power ⁽¹⁾
- R** 24v AC (50/60 Hz)
- T** 110v AC (50/60 Hz)
- N** 220v AC (50/60 Hz)
- U** 240v AC (50/60 Hz)

* A comprehensive range of non-standard voltages available on request

Note:

- (1) "H" option not available with Exia solenoids
- (2) IECEx only available with Exia and Exd Solenoids
- (3) GOST CU TR only available with Exd solenoids
- (4) NEPSI only available with Exia and Exd solenoids

Designator

- A** ATEX
- B** Exia 10mA
- C** IECEx ⁽²⁾
- E** Exme 0.5W
- G** ATEX Exd IIB
- H** Exm
- J** Exme 2.4W
- R** GOST CU TR ⁽³⁾
- X** NEPSI ⁽⁴⁾

Options 2

- B** Valve body brass
- C** Valve body brass and NPT ports
- D** Valve body brass, NPT ports and 1/2" NPT electrical connection
- E** 1/2" NPT electrical connection
- L** Low temperature duty -40°C
- M** NPT ports and 1/2" NPT electrical connection
- N** NPT ports
- P** Valve body stainless steel, NPT ports and 1/2" NPT electrical connection
- R** Valve body stainless steel and NPT ports
- S** Valve body stainless steel
- X** Valve suitable for use with Oxygen

* A comprehensive range of non-standard options available on request

COIL ORIENTATION

The coil itself can be rotated in 90° steps by releasing the four securing screws. (FIG 1) When rotating the coil care should be taken to ensure the core assembly (core, spring, seal and washer) remains intact and aligned correctly. This is easily achieved by only lifting the coil the small amount required to clear the screws enabling the coil to be rotated.

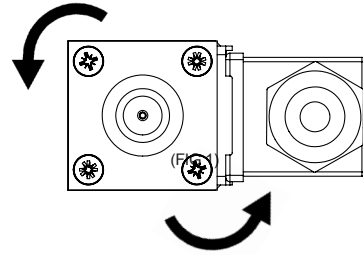

MATERIAL SPECIFICATIONS

	STANDARD
Body And End Caps	Black Anodised Aluminium (Dural)
Spool	Hard Anodised Aluminium PTFE Impregnated
Jet	Brass
Spacers	Glass Filled Acetal
Seals	Nitrile
Spring	Music Wire

VALVE SPECIFICATIONS

	STANDARD
Inlet Port Connection Size	1/2" BSP
Working Pressure Internal Pilot Version	3 to 10 bar
Working Pressure External Pilot Version	3 to 10 bar
Minimum External Pilot Pressure	3 bar
Cv Factor	3.5
Flow Rate (at 6 bar with 1 bar pressure drop)	3534 l/min
Maximum Ambient Temperature	+80 °C
Minimum Working Temperature	-20 °C

COIL DETAILS

Coil Type	Plug & Socket	Terminal Box	ExnA	Exd	Exm	Exia
Area Class	Safe	Safe	Zone 2	Zones 1 & 2	Zones 1 & 2	Zone 0, 1 & 2
Area Category	N/A	N/A	ExN II T4-T6	Exd IIC T3-T6	Exm IIC T5	Exia IIC T6
Ingress Protection	IP65	IP65	IP65	IP66	IP65	IP65
Cable Entry	PG.9	M20 x 1.5	M20 x 1.5	M20 x 1.5	Flying leads	M20 x 1.5
Ambient Temperature	-20 to +80 °C	-20 to +80 °C	-40 to +60 °C	-60 to +80 °C	-20 to +65 °C	-40 to +65 °C
Magnetic Wire Class	H	H	H	H	H	H

*** FURTHER SOLENOID OPTIONS AVAILABLE ON REQUEST**

DIMENSIONS (mm)

5/2 Position

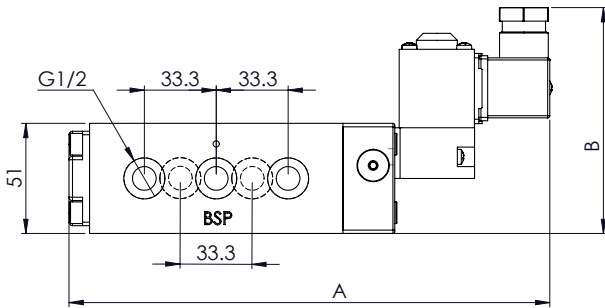
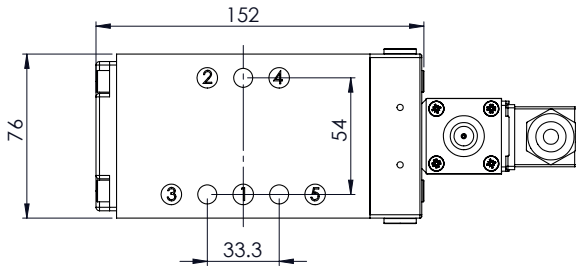

COIL TYPE

COIL TYPE	A	B
Plug & Socket	223	105
MC30 Coil	215	100
Terminal Box	220	114
ExnA	220	114
Exd	236	126
Exia	188	120
Exm	188	96

5/3 Position

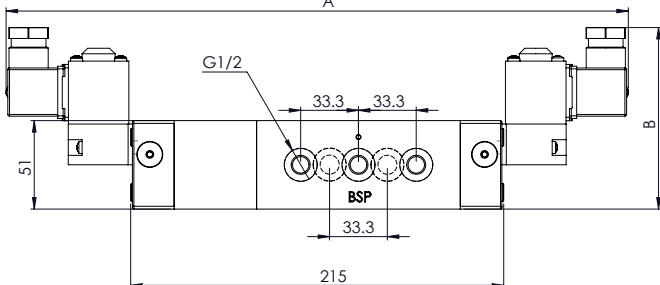
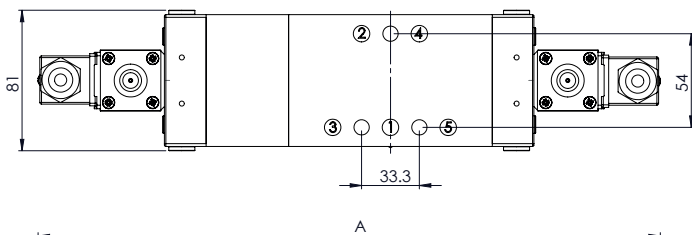

COIL TYPE

COIL TYPE	A	B
Plug & Socket	357	105
MC30 Coil	341	100
Terminal Box	351	114
ExnA	351	114
Exd	383	126
Exia	287	120
Exm	287	96