

# Flush Silhouette Switches

LB Series / LBW Series

## ø16mm LB Series

Miniature Switches and Pilot Lights



# Stylish and Functional

IDEC's extensive range of LB/LBW series switches can be used for a wide range of applications.

## Flush Silhouette

### LB Series Flush Silhouette Switches

Slim 2mm-thick bezels for stylish panels.

### LBW Series Flush Silhouette Switches

Smart appearance with large surface for secure operation.



### Flush Silhouette

Projects only 2mm from the panel surface. For sleek and refined style.

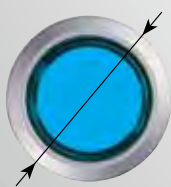

**LB Series Bezel**  
ø22/□22mm

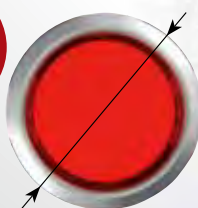

**LBW Series Bezel**  
ø26/□26mm

New LBW series with ø26/□26mm bezels. Large button surface for easy usability. Ideal for frequently used switches such as STOP and START. (Actual size)

## Miniature Switches and Pilot Lights

### ø16mm LB Series Miniature Switches and Pilot Lights

Short body for space-saving installation.

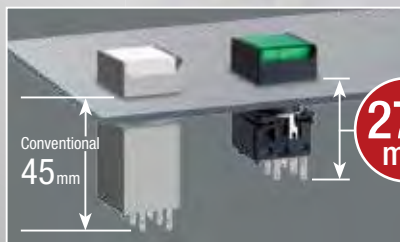

**27.9 mm**

### Short Body

Depth of only 27.9mm behind panel. Reduces the size of machines and control panels.

Compact

## Flush Silhouette & Miniature Switches and Pilot Lights

### Removable Contact Block /Single Board Mounting

Removable contacts enable easy wiring / Single board mounting for space-saving installation.

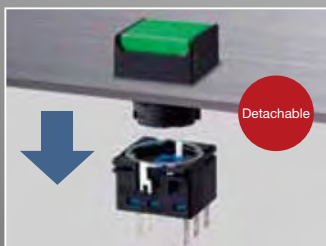

Detachable



For details on UP series **P.52**



### Waterproof

Degree of protection: IP65



Detachable & Single Board

New UP series has the same depth as LB/LBW series. Mounts on the same panel. (Flush bezel: 34.9mm, standard bezel: 27.9mm)

Waterproof



# LB Series and LBW Series For diverse applications



Flush silhouette switches and  $\varnothing 16\text{mm}$  miniature switches and pilot lights. Wide variety of switches to choose from.

(13/09/30)



New LBW series with large operator surface for easy usability.

# LB SERIES

## Flush Silhouette Switches

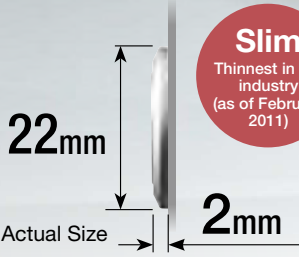

**Slim**  
Thinnest in the industry  
(as of February 2011)

Protection degree: IP65 (IEC 60529)

For sleek and refined style

\* Panel cutout (mm)



### Illuminated Pushbuttons

Illuminated pushbuttons with switch guard available



### Pushbuttons

Marking plates can be used with lens style pushbuttons



\*Does not light on.



Pushbuttons with switch guard available

Round  
ø18.2\*

Square  
□18.2\*

Rectangular  
18.2 x 24.2\*



### Pilot Lights

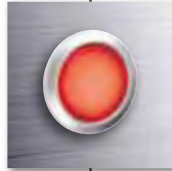

### Dome Pilot Lights

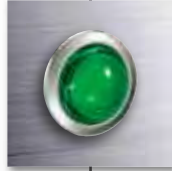

### Selector Switches

2-position and 3-position selector switches. Maintained and other various spring return actions available.

\*Photo: lever operator (knob operator also available)

Illuminated selector switches available

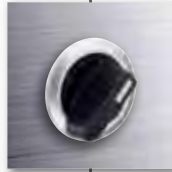

Wave Key

**Key Selectors**  
ensure safety

Seven different keys to choose from. Key removable in desired positions.



### Buzzer

Protection degree: IP54  
Steady sound at 80 dB minimum (at 0.1m)



### Lever Switches

Degree of protection: IP67  
Up/down operation.  
2- and 3-positions available.  
For 3-position switches, maintained and return two-way actions available.

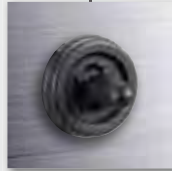

# LBW SERIES

## Flush Silhouette Switches

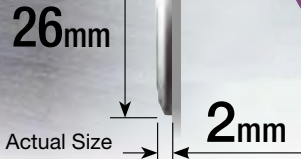

**Slim**  
Thinnest in the industry  
(as of May 2012)

Projects only 2mm from the panel. Removable contact blocks ideal for single board mounting.  $\varnothing 26/\square 26$  bezel size for easy operation.

For sleek and refined style



### Illuminated Pushbuttons

Illuminated pushbuttons with switch guard available



### Ring-illuminated Pushbuttons



### Pushbuttons

Marking plates can be used with lens style pushbuttons



\*Does not light on.



Pushbuttons with switch guard available

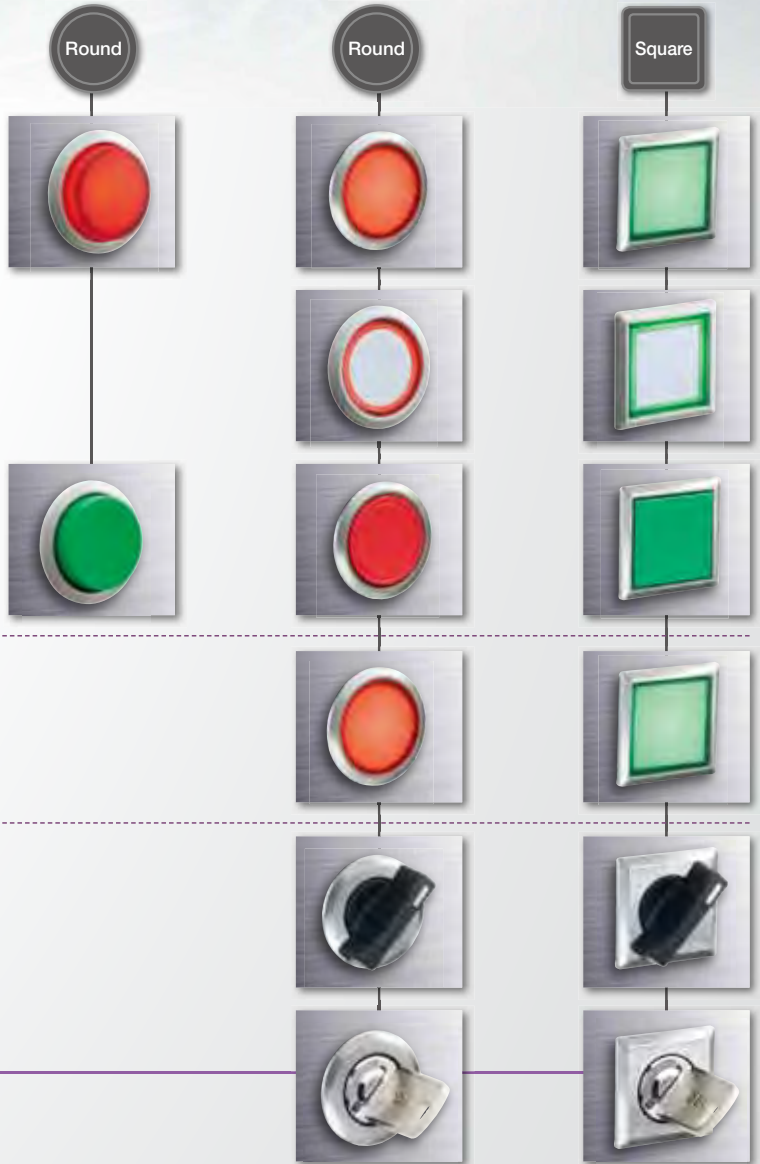

### Pilot Lights



### Selector Switches

2-position and 3-position selector switches. Maintained and spring return actions available.



Key Selectors ensure safety

Wave Key

Seven different keys to choose from. Key removable in desired positions.

Stylish Appearance with Advanced Functions

Operation status is easily visible due to illumination on the operator.



Illuminated Selector Switch (LB series only)



Switch guard prevents inadvertent switch operation

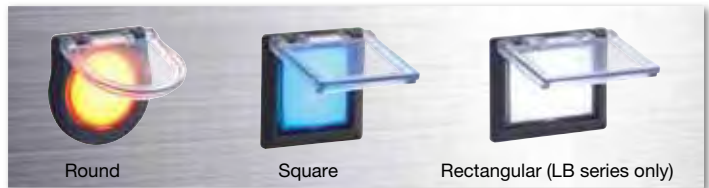

#### Illuminated Pushbutton Color Variations

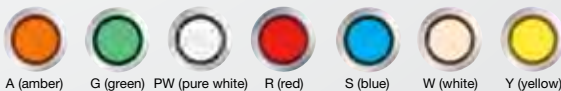

#### Pushbutton Color Variations

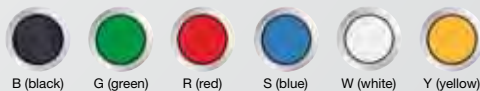

#### Bezel Color Variations



#### Ring-Illuminated Pushbutton Color Variations



#### Ring-Illuminated Pushbutton Bezels

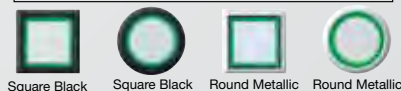

(13/09/30)

# Ø16mm LB SERIES

## Miniature Switches and Pilot Lights (Standard Bezel)

Panel depth of only 27.9mm.  
Removable contact blocks ideal for single board mounting.  
Protection degree: IP65 (IEC 60529)

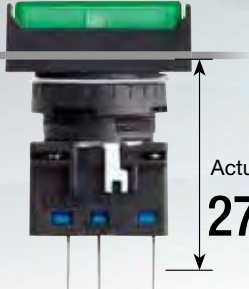

**Short**  
Shortest in the industry  
(as of February 2011)

Actual Size  
**27.9mm**

For space-saving installation



### Illuminated Pushbuttons



### Pushbuttons

Marking plates can be used with lens style pushbuttons  
  
\*Does not light on.



### Pilot Lights



### Dome Pilot Lights



### Selector Switches

2- and 3-position selector switches. Maintained and other various spring return actions available.  
\*Photo: knob operator (lever operator also available)  
Illuminated selector switches available



**Key Selectors**  
ensure safety

Wave Key

Seven different keys to choose from. Key removable in desired positions.



### Buzzers

Steady sound at 80 dB minimum (at 0.1m)  
IP54 tab terminals, PC board terminal, and IP40 solder terminals available.



### Lever Switches

Degree of protection: IP67  
Up/down operation.  
2- and 3-positions available.  
For 3-position switches, maintained and return two-way actions available.

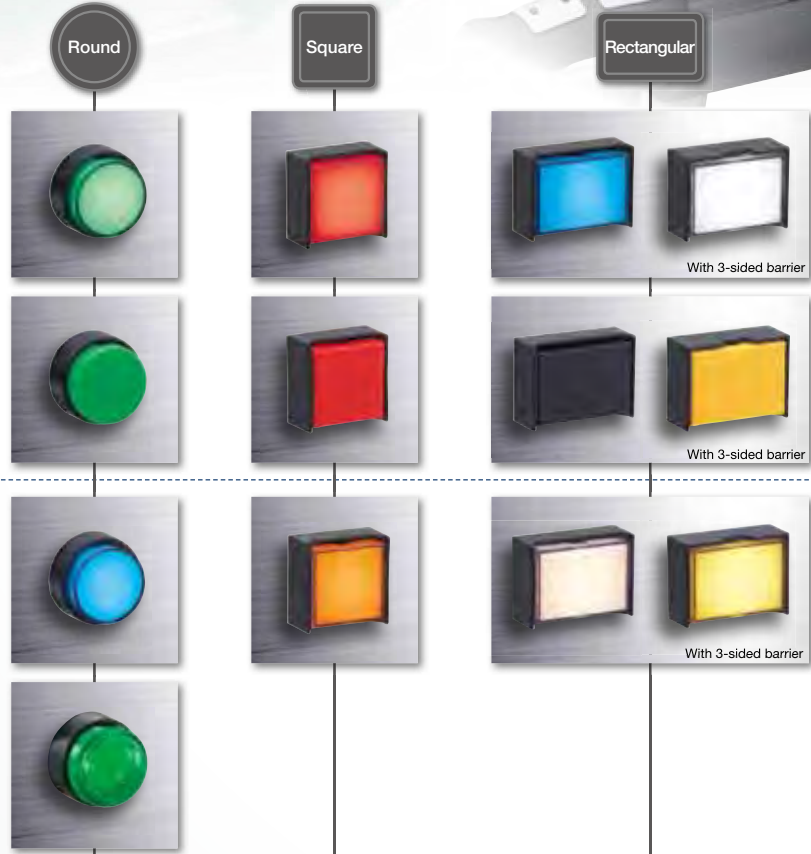

Illuminated Pushbutton Color Variations



Pushbutton Color Variations



# Flush Silhouette Switches LB Series

# Flush Silhouette Switches LBW Series

## ø16mm LB Series Switches and Pilot Lights

**Flush bezel projects only 2 mm from front of panel. Standard bezel with only a panel depth of 27.9 mm. Removable contact blocks ideal for single board mounting.**

- Pushbuttons, selector switches, and key selector switches with up to 3PDT contacts.
- Wave keys are used for key selector switches to prevent duplication of keys. Six different keys are available besides standard key.
- Black or metallic flush bezels available.
- Bright and clear illumination surface. LED illumination.
- Gold-clad, cross-bar contact, or high-capacity silver contacts.
- Protection degree: IP65 (IEC60529)

Applicable Standards	Mark	File No. or Organization
UL508		UL Recognition No.E55996
CSA 22.2 No.14		CSA File No. LR 21451
EN60947-5-1		TÜV Rheinland
		EU Low Voltage Directive
GB14048.5		See page 49 for the CCC number.

• See page 49 for approval ratings.

### Contact Ratings

#### Gold Contact (switch base: blue)

Rated Insulation Voltage	250V	
Rated Thermal Current	3A	
Rated Operating Voltage	30V DC	125V AC
Rated Operating Current (resistive load)	0.1A	0.1A
Contact Material	Gold-clad silver	

• Minimum applicable load (reference value): 5V AC/DC, 1 mA  
Applicable range is subject to the operating conditions and load.

#### Silver Contact (switch base: gray)

Rated Insulation Voltage	250V					
Rated Operating Voltage	30V	125V	250V			
Rated Operating Current	Electrical Life 50,000 operations	AC 50/60Hz	Resistive load	—	5A	5A
		DC	Inductive load	—	3A	1.5A
			Resistive load	5A	1.1A	—
	Electrical Life 100,000 operations	AC 50/60Hz	Inductive load	2A	0.4A	—
			Resistive load	—	5A	3A
		DC	Resistive load	3A	0.6A	—
Inductive load	1A	0.22A	—			
Rated Thermal Current	5A					
Contact Material	Silver					

• AC inductive load: PF=0.6 to 0.7 DC inductive load: L/R=7 ms max.

### LED Ratings

Rated Voltage	5V DC	12V AC/DC	24V AC/DC
Voltage Range	5V DC±5%	12V AC/DC±10%	24V AC/DC±10%
LED Part No.	LB9Z-LED5②	LB9Z-LED1②	LB9Z-LED2②
Current Draw	A, R, W: 22 mA G, PW, S: 16 mA		
Voltage Marking	Marked on the side of the LED unit		
LED Life (reference value)	Approx. 30,000 hours (until the brightness reduces to 50% the initial value when lit at complete direct current the rated voltage under 25°C environment.)		
Internal Circuit	A, PW, R, W		A, PW, R, W
	G, S		G, S

• ② (color code): A (amber), G (green), PW (pure white), R (red), S (blue), W (white)

- Use the pure white (PW) module for yellow illumination.
- LED lamp contains a current-limiting resistor.



### Specifications

Operating Temperature	-25 to +60°C (no freezing) Illuminated units: -25 to +55°C	
Storage Temperature	-30 to +80°C (no freezing)	
Operating Humidity	45 to 85% RH (no condensation)	
Contact Resistance	50 mΩ maximum (initial value)	
Insulation Resistance	100 MΩ minimum (500V DC megger)	
Dielectric Strength	Switch Unit	Between live part and ground: 2,000V AC, 1 minute Between terminals of different poles: 2,000V AC, 1 minute Between terminals of the same poles: 1,000V AC, 1 minute
	Illumination Unit	Between live part and ground: 2,000V AC, 1 minute
Vibration Resistance	Operating extremes/Damage limits: 5 to 55 Hz, amplitude 0.5 mm	
Shock Resistance	Operating extremes: 100 m/s <sup>2</sup> Damage limits: 1,000 m/s <sup>2</sup>	
Mechanical Life (minimum operations)	Momentary:	2,000,000
	Maintained:	250,000
	Selector switches	250,000
	Key selector switches	250,000
Electrical Life (minimum operations)	Momentary:	50,000 / 100,000 (*1)
	Maintained:	50,000 / 100,000 (*2)
	Selector switches:	50,000 / 100,000 (*2)
	Key selector switches:	50,000 / 100,000 (*2)
Degree of Protection	IP65 (IEC 60529)	
Terminal Style	Solder/tab terminal #110 PC board terminal	
Weight (approx.)	11g (LB3L-M1T24)	15g (LB8GL-M1T24)
	10g (LB3P-1T04)	14g (LB8GB-M1T2)
	10g (LB3B-M1T2)	16g (LBW7L-M1T24)
	12g (LB3S-2T2)	14g (LBW7P-1T04)
	25g (LB3K-2ST2A)	15g (LBW7B-M1T2)
	14g (LB8L-M1T24)	17g (LBW7S-2T2)
	13g (LB8P-1T04)	29g (LBW7K-2ST2A)
	13g (LB8B-M1T2)	17g (LBW7GL-M1T24)
	15g (LB8S-2T2)	18g (LBW7GB-M1T2)
	27g (LB8K-2ST2A)	

\* 1: Switching frequency 1,800 operations/h.

\* 2: Switching frequency 1,200 operations/h.

# Flush Silhouette Switches LB Series Illuminated Pushbuttons

## Illuminated Pushbuttons

Solder/Tab Terminal

Package Quantity: 1

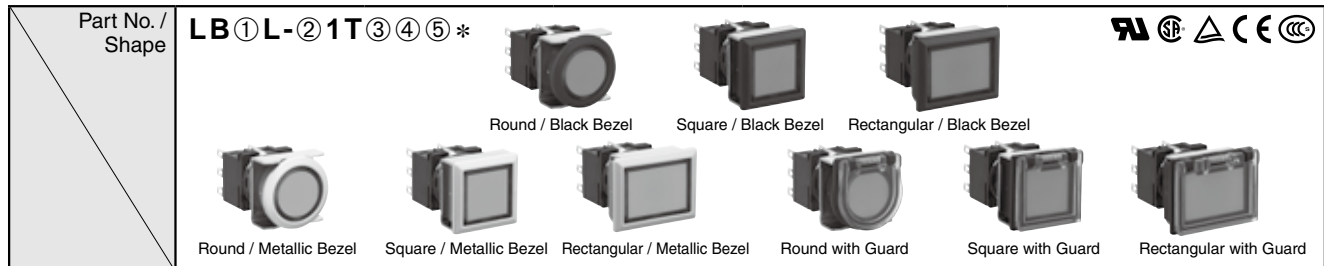

① Shape	② Operation	③ Contact	④ LED Operating Voltage	Part No.	* Illumination Color Code
Black bezel	Momentary	Gold/SPDT	24V AC/DC	LB①L-M1T14*	Specify the color code in place of * in the Part No.  A: amber G: green PW: pure white R: red S: blue W: white Y: yellow
		Gold/DPDT		LB①L-M1T24*	
	Maintained	Gold/SPDT	24V AC/DC	LB①L-A1T14*	
		Gold/DPDT		LB①L-A1T24*	
Metallic bezel	Momentary	Gold/SPDT	24V AC/DC	LB①L-M1T14*	
		Gold/DPDT		LB①L-M1T24*	
	Maintained	Gold/SPDT	24V AC/DC	LB①L-A1T14*	
		Gold/DPDT		LB①L-A1T24*	
Guard Type	Momentary	Gold/SPDT	24V AC/DC	LB①L-M1T14*	
		Gold/DPDT		LB①L-M1T24*	
	Maintained	Gold/SPDT	24V AC/DC	LB①L-A1T14*	
		Gold/DPDT		LB①L-A1T24*	

- Illuminated pushbuttons contain an LED unit. For details on LED units, see page 60.
- The guard opens 180 degrees spring-return.
- Illuminated pushbuttons can be used with legend markings. Engraving can be done on a marking plate which is placed in the lens, or a clear film can be printed and placed in the lens. See page 63 for details on the marking plate and film.
- White lens type (when light is off) are available. Clear lens is used instead of colored lens for amber, green, red, and blue illuminated pushbuttons. Amber, green, red, or blue LED units are used. To specify, see Part Number Development below.
- PC board terminals available for gold contacts. Silver contacts also available. To specify, see Part Number Development below.
- 5V DC and 12V AC/DC LED operating voltages also available.
- Other bezel sizes available (LBW series). For details, see page 24.

## Part Number Development

LB①L-②1T③④⑤\*

### ① Shape

Code	Shape
6	Round / Black Bezel
7	Square / Black Bezel
8	Rectangular / Black Bezel
6M	Round / Metallic Bezel
7M	Square / Metallic Bezel
8M	Rectangular / Metallic Bezel
6G	Round with Guard
7G	Square with Guard
8G	Rectangular with Guard

### ② Operation

Code	Operation
A	Maintained
M	Momentary

### ③ Contacts

Code	Contact
1	Gold/SPDT
2	Gold/DPDT
5	Silver/SPDT
6	Silver/DPDT

### ④ LED Operating Voltage

Code	Rated Operating Voltage
1	5V DC
3	12V AC/DC
4	24V AC/DC

### ⑤ Others

Code	Specification	Part No. Example
Blank	Solder/Tab Terminal	—
W	White Lens Type (When Light is Off)	LB6L-M1T14W*
V	PC Board Terminal (Gold Contact Only)	LB6L-M1T14V*
VW	White Lens Type (When Light is Off) with PC Board Terminal (Gold Contact Only)	LB6L-M1T14VW*

- Specify the color code in place of \* in the table above.
- Color code for white lens type (when light is off) : A (amber), G (green), R (red), S (blue)



# Flush Silhouette Switches LB series Illuminated Pushbuttons

## Dimensions

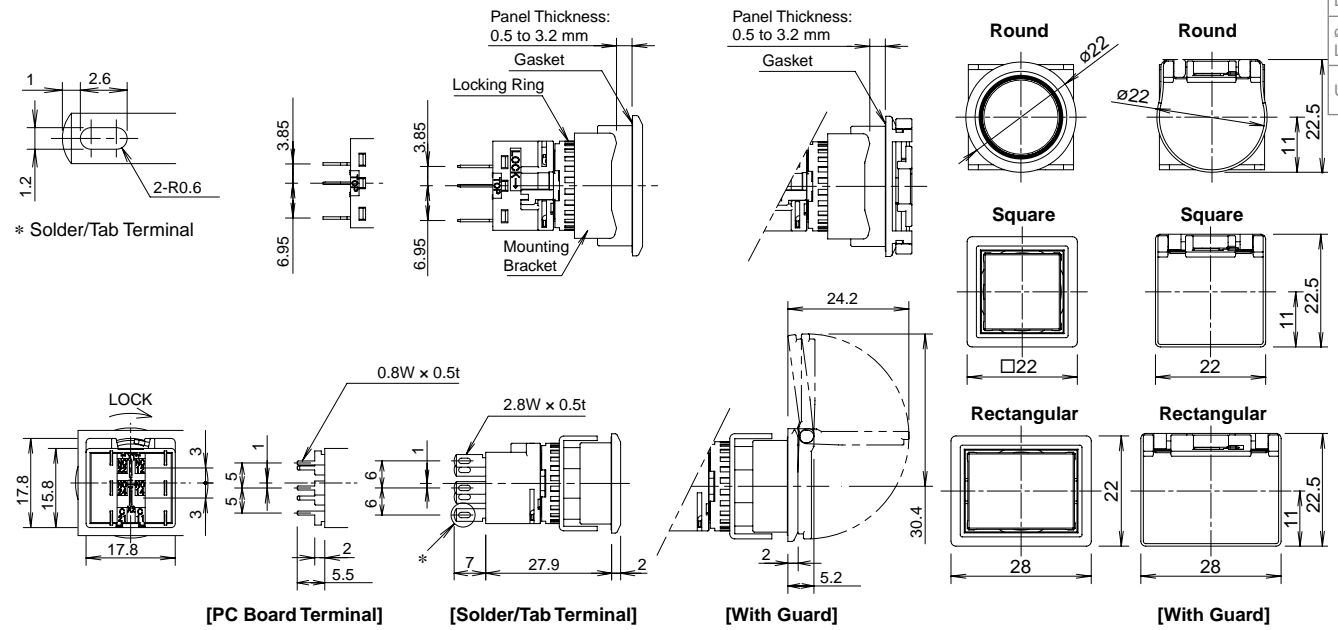

All dimensions in mm.

## Terminal Arrangement (Bottom View)

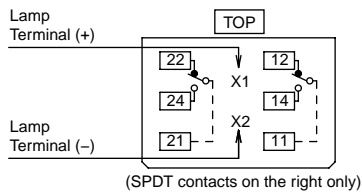

## Mounting Hole Layout

Round (LB6/LB6M)

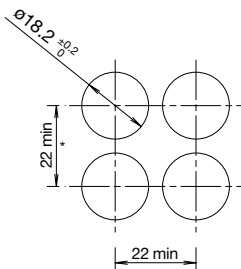

Square (LB7/LB7M)

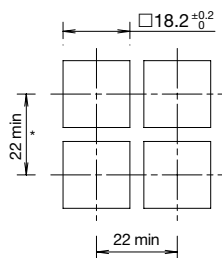

Square (LB8/LB8M)

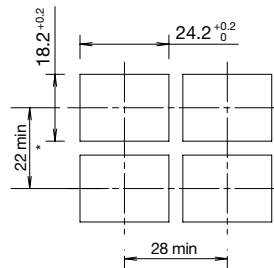

\* 45 mm minimum for switches with guard  
 Note: When using rubber boot or terminal cover, see dimensions on page 57 and 58.

- For details on pc board and circuit design, see page 50.
- For details on single board mounting, see page 51.

Flush Silhouette LB Series
Flush Silhouette LBW Series
ø16 LB Series
UP Series



Illuminated Pushbutton
Pilot Light
Pushbutton
Selector
Illuminated Selector
Key Selector
Lever Switch
Buzzer
Accessories
Maintenance Parts
Panel Cut-out
Instructions

# Flush Silhouette Switches LB Series Pilot Lights

## Pilot Lights

Solder/Tab Terminal

Package Quantity: 1

Part No. / Shape	<b>LB①P-②T③④*</b>							
								
② Lens Shape	① Shape	③ LED Operating Voltage	Part No.	* Illumination Color Code				
Flush	Black Bezel	24V AC/DC	<b>LB①P-1T04*</b>	Specify the color code in place of * in the Part No.  A: amber G: green PW: pure white R: red S: blue W: white Y: yellow				
	Metallic Bezel	24V AC/DC	<b>LB①P-1T04*</b>					
Dome	Black Bezel	24V AC/DC	<b>LB6P-2T04*</b>					
	Metallic Bezel	24V AC/DC	<b>LB6MP-2T04*</b>					

- Pilot lights contain an LED unit. For maintenance LED units see page 60.
- White lens type (when light is off) are available. Clear lens is used instead of colored lens for amber, green, red, and blue pilot lights. Amber, green, red, or blue LED units are used. To specify, see Part Number Development below.
- PC board terminals available. To specify, see Part Number Development below.
- 5V DC and 12V AC/DC LED operating voltages also available.
- Other bezel sizes available (LBW series). For details, see page 26.

## Part Number Development

### LB①P-②T③④\*

#### ① Shape

Code	Shape
6	Round / Black Bezel
7	Square / Black Bezel
8	Rectangular / Black Bezel
6M	Round / Metallic Bezel
7M	Square / Metallic Bezel
8M	Rectangular / Metallic Bezel

- Round only for dome.

#### ② Lens Shape

Code	Lens Shape
1	Flush
2	Dome

#### ③ LED Operating Voltage

Code	Rated Operating Voltage
1	5V DC
3	12V AC/DC
4	24V AC/DC

#### ⑤ Others

Code	Specification	Part No. Example
Blank	Solder/Tab Terminal	—
W	White Lens Type (When Light is Off)	LB6P-1T04W*
V	PC Board Terminal	LB6P-1T04V*
VW	White Lens Type (When light is Off) with PC Board Terminal	LB6PPM1T14VW*

- Specify the color code in place of \* in the table above.
- Color code for white lens type (when light is off) : A (amber), G (green), R (red), S (blue)

# Flush Silhouette Switches LB Series Pilot Lights

Flush Silhouette LB Series
Flush Silhouette LBW Series
ø16 LB Series
UP Series

## Dimensions

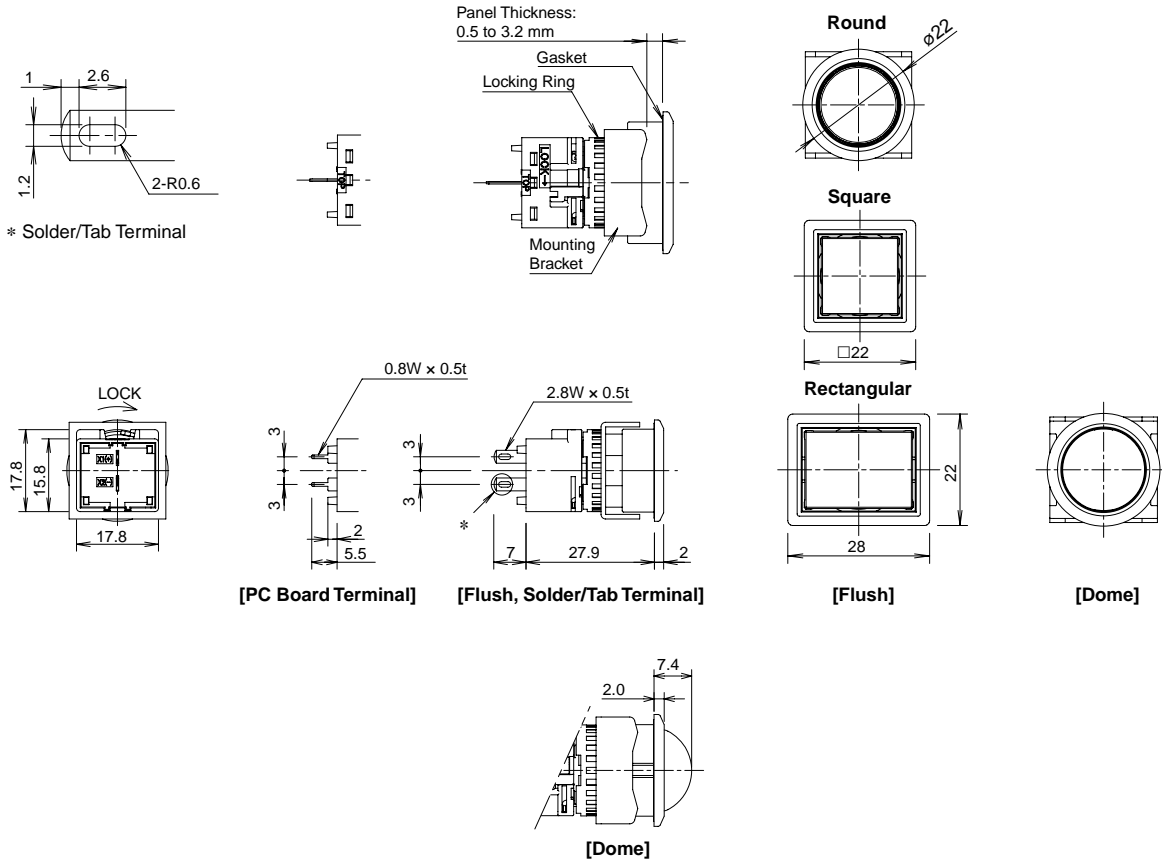

All dimensions in mm.

## Terminal Arrangement (Bottom View)

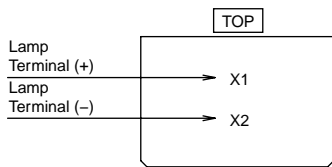

## Mounting Hole Layout

### Round (LB6/LB6M)

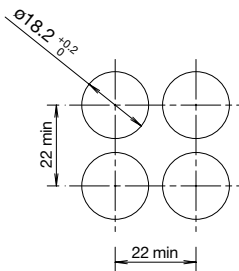

### Square (LB7/LB7M)

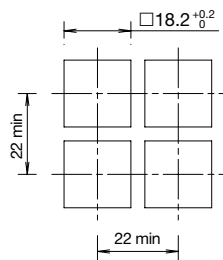

### Square (LB8/LB8M)

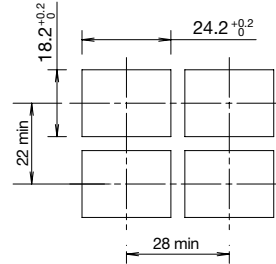

Note: When using rubber boot or terminal cover, see dimensions on page 57 and 58.

- For details on pc board and circuit design, see page 50.
- For details on single board mounting, see page 51.

Illuminated Pushbutton
<b>Pilot Light</b>
Pushbutton
Selector
Illuminated Selector
Key Selector
Lever Switch
Buzzer
Accessories
Maintenance Parts
Panel Cut-out
Instructions

# Flush Silhouette Switches LB Series Pushbuttons

## Pushbuttons

Solder/Tab Terminal

Package Quantity: 1

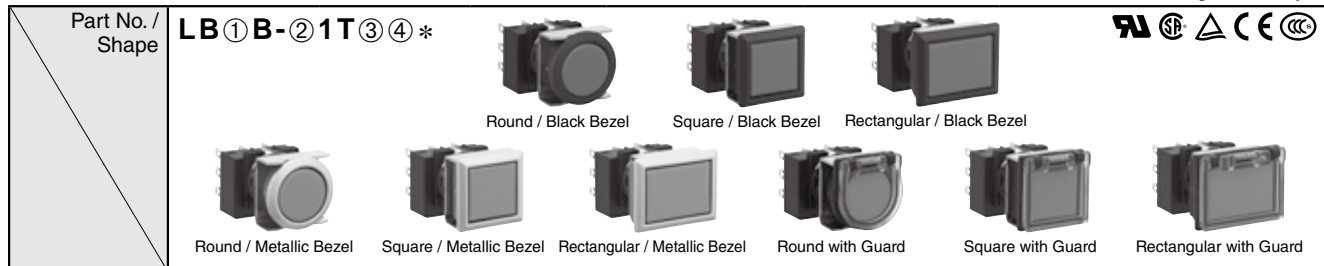

① Shape	Button Style	② Operation	③ Contact	Part No.		* Color Code
				Gold Contact	Silver Contact	
Black bezel	Button	Momentary	SPDT	LB①B-M1T1*	LB①B-M1T5*	B: black G: green R: red S: blue W: white Y: yellow
			DPDT	LB①B-M1T2*	LB①B-M1T6*	
			3PDT	LB①B-M1T3*	LB①B-M1T7*	
		Maintained	SPDT	LB①B-A1T1*	LB①B-A1T5*	
			DPDT	LB①B-A1T2*	LB①B-A1T6*	
			3PDT	LB①B-A1T3*	LB①B-A1T7*	
	Lens	Momentary	SPDT	LB①B-M1T1L*	LB①B-M1T5L*	A: amber G: green R: red S: blue W: white Y: yellow
			DPDT	LB①B-M1T2L*	LB①B-M1T6L*	
			3PDT	LB①B-M1T3L*	LB①B-M1T7L*	
		Maintained	SPDT	LB①B-A1T1L*	LB①B-A1T5L*	
			DPDT	LB①B-A1T2L*	LB①B-A1T6L*	
			3PDT	LB①B-A1T3L*	LB①B-A1T7L*	
Metallic bezel	Button	Momentary	SPDT	LB①B-M1T1*	LB①B-M1T5*	B: black G: green R: red S: blue W: white Y: yellow
			DPDT	LB①B-M1T2*	LB①B-M1T6*	
			3PDT	LB①B-M1T3*	LB①B-M1T7*	
		Maintained	SPDT	LB①B-A1T1*	LB①B-A1T5*	
			DPDT	LB①B-A1T2*	LB①B-A1T6*	
			3PDT	LB①B-A1T3*	LB①B-A1T7*	
	Lens	Momentary	SPDT	LB①B-M1T1L*	LB①B-M1T5L*	A: amber G: green R: red S: blue W: white Y: yellow
			DPDT	LB①B-M1T2L*	LB①B-M1T6L*	
			3PDT	LB①B-M1T3L*	LB①B-M1T7L*	
		Maintained	SPDT	LB①B-A1T1L*	LB①B-A1T5L*	
			DPDT	LB①B-A1T2L*	LB①B-A1T6L*	
			3PDT	LB①B-A1T3L*	LB①B-A1T7L*	
Guard Type	Button	Momentary	SPDT	LB①B-M1T1*	LB①B-M1T5*	B: black G: green R: red S: blue W: white Y: yellow
			DPDT	LB①B-M1T2*	LB①B-M1T6*	
			3PDT	LB①B-M1T3*	LB①B-M1T7*	
		Maintained	SPDT	LB①B-A1T1*	LB①B-A1T5*	
			DPDT	LB①B-A1T2*	LB①B-A1T6*	
			3PDT	LB①B-A1T3*	LB①B-A1T7*	
	Lens	Momentary	SPDT	LB①B-M1T1L*	LB①B-M1T5L*	A: amber G: green R: red S: blue W: white Y: yellow
			DPDT	LB①B-M1T2L*	LB①B-M1T6L*	
			3PDT	LB①B-M1T3L*	LB①B-M1T7L*	
		Maintained	SPDT	LB①B-A1T1L*	LB①B-A1T5L*	
			DPDT	LB①B-A1T2L*	LB①B-A1T6L*	
			3PDT	LB①B-A1T3L*	LB①B-A1T7L*	

- The guard opens 180 degrees spring-return.
- Illuminated pushbuttons can be used with legend markings. Engraving can be done on a marking plate which is placed in the lens, or a clear film can be printed and placed in the lens. See page 63 for details on the marking plate and film.
- Black is available for lens. Black lens consists of a transparent lens and a black marking plate. To specify, see Part Number Development below.
- PC board terminals available for gold contacts. To specify, see Part Number Development below.
- Other bezel sizes available (LBW series). For details, see page 28.

## Part Number Development LB ① B-② 1T ③ ④ \*

### ① Shape

Code	Shape
6	Round / Black Bezel
7	Square / Black Bezel
8	Rectangular / Black Bezel
6M	Round / Metallic Bezel
7M	Square / Metallic Bezel
8M	Rectangular / Metallic Bezel
6G	Round with Guard
7G	Square with Guard
8G	Rectangular with Guard

### ② Operation

Code	Operation
A	Maintained
M	Momentary

### ③ Contacts

Code	Contact	Code	Contact
1	Gold/SPDT	5	Silver/SPDT
2	Gold/DPDT	6	Silver/DPDT
3	Gold/3PDT	7	Silver/3PDT

### ④ Others

Code	Specification	Part No. Example
Blank	Solder/Tab Terminal	—
B	Black Translucent Lens (Lens Only)	LB6B-M1T1LB
V	PC Board Terminal (Gold Contact Only)	LB6B-M1T1V*

# Flush Silhouette Switches LB Series Pushbuttons

## Dimensions

Flush Silhouette LB Series
Flush Silhouette LBW Series
ø16 LB Series
UP Series

All dimensions in mm.

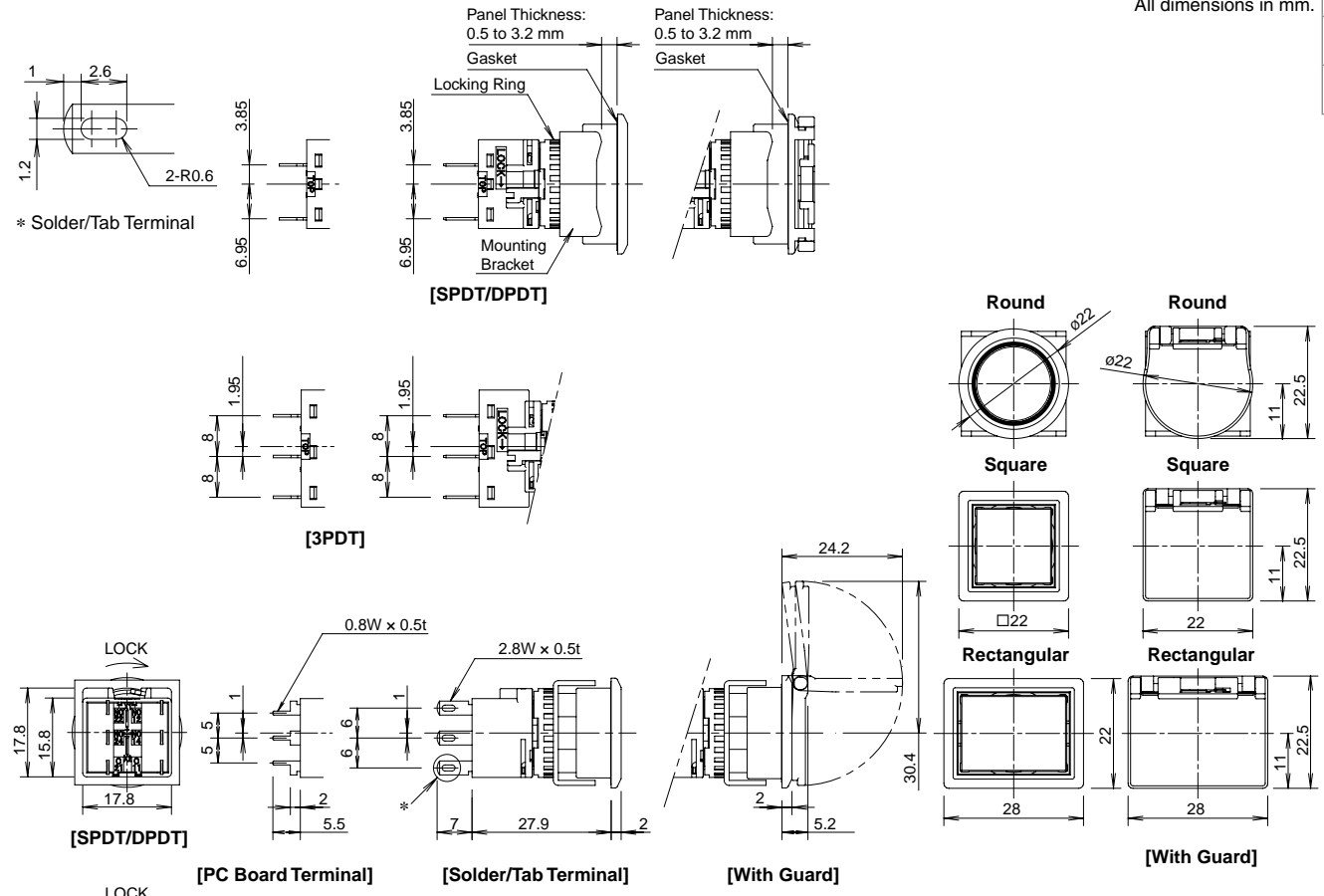

Illuminated Pushbutton
Pilot Light
<b>Pushbutton</b>
Selector
Illuminated Selector
Key Selector
Lever Switch
Buzzer
Accessories
Maintenance Parts
Panel Cut-out
Instructions

### Terminal Arrangement (Bottom View)

#### SPDT/DPDT Contacts

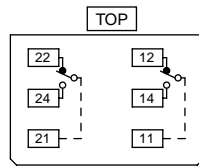

(SPDT contacts on the right only)

#### 3PDT Contacts

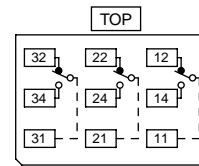

### Mounting Hole Layout

#### Round (LB6/LB6M)

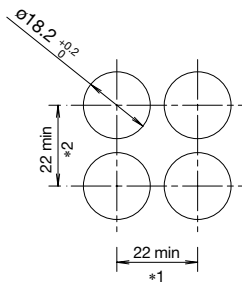

#### Square (LB7/LB7M)

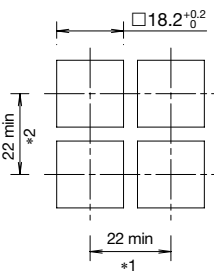

#### Rectangular (LB8/LB8M)

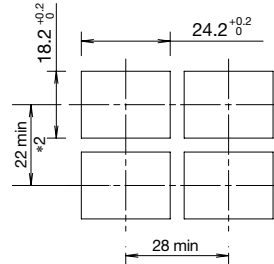

\*1: 23.2 mm minimum for 3PDT

\*2: 45 mm minimum for switches with guard

Note: When using rubber boot or terminal cover, see dimensions on page 57 and 58.

- For details on pc board and circuit design, see page 50.
- For details on single board mounting, see page 51.

# Flush Silhouette Switches LB Series Selector Switches

## Selector Switches

Solder/Tab Terminal







Package Quantity:1

Part No. / Shape **LB①S-②③T④⑤** 

Knob Operator



Round / Black Bezel    Square / Black Bezel    Rectangular / Black Bezel    Round / Metallic Bezel    Square / Metallic Bezel    Rectangular / Metallic Bezel

① Shape	② Operator Position		③ Contact	Part No.	
				Gold Contact	Silver Contact
Black bezel	90° 2-position	Maintained 	SPDT	<b>LB①S-2T1</b>	<b>LB①S-2T5</b>
			DPDT	<b>LB①S-2T2</b>	<b>LB①S-2T6</b>
			3PDT	<b>LB①S-2T3</b>	<b>LB①S-2T7</b>
	45° 3-position	Maintained 	DPDT	<b>LB①S-3T2</b>	<b>LB①S-3T6</b>
			3PDT	<b>LB①S-3T3</b>	<b>LB①S-3T7</b>
		Spring return two-way 	DPDT	<b>LB①S-33T2</b>	<b>LB①S-33T6</b>
Metallic bezel	90° 2-position	Maintained 	SPDT	<b>LB①S-2T1</b>	<b>LB①S-2T5</b>
			DPDT	<b>LB①S-2T2</b>	<b>LB①S-2T6</b>
			3PDT	<b>LB①S-2T3</b>	<b>LB①S-2T7</b>
	45° 3-position	Maintained 	DPDT	<b>LB①S-3T2</b>	<b>LB①S-3T6</b>
			3PDT	<b>LB①S-3T3</b>	<b>LB①S-3T7</b>
		Spring return two-way 	DPDT	<b>LB①S-33T2</b>	<b>LB①S-33T6</b>
			3PDT	<b>LB①S-33T3</b>	<b>LB①S-33T7</b>

- Lever operators also available. To specify, see Part Number Development below.
- PC board terminals available for gold contacts. To specify, see Part Number Development below.
- 2-position spring return from right, 3-position spring return from right, and 3-position spring return from left also available. To specify, see Part Number Development below.
- For contact operation, see page 48.
- Other bezel sizes available (LBW series). For details, see page 30.

Lever Operator



## Part Number Development



**LB①S-②③T④⑤**

### ① Shape





Code	Shape
6	Round / Black Bezel
7	Square / Black Bezel
8	Rectangular / Black Bezel
6M	Round / Metallic Bezel
7M	Square / Metallic Bezel
8M	Rectangular / Metallic Bezel

### ② Operator Position

#### 2-position

Operator Position	
<b>2</b> Maintained 	<b>21</b> Spring return from right 

#### 3-position

Operator Position			
<b>3</b> Maintained 	<b>31</b> Spring return from right 	<b>32</b> Spring return from left 	<b>33</b> Spring return two-way 

### ③ Operator

Code	Operator Shape
Blank	Knob
L	Lever

### ④ Contacts

Code	Contact
1	Gold/SPDT (90° 2-position only)
2	Gold/DPDT
3	Gold/3PDT
5	Silver/SPDT (90° 2-position only)
6	Silver/DPDT
7	Silver/3PDT

### ⑤ Others

Code	Specification	Part No. Example
Blank	Solder/Tab Terminal	—
V	PC Board Terminal (Gold Contact Only)	LB6S-2T1V

# Flush Silhouette Switches LB Series Selector Switches

Flush Silhouette LB Series
Flush Silhouette LBW Series
ø16 LB Series
UP Series

## Dimensions

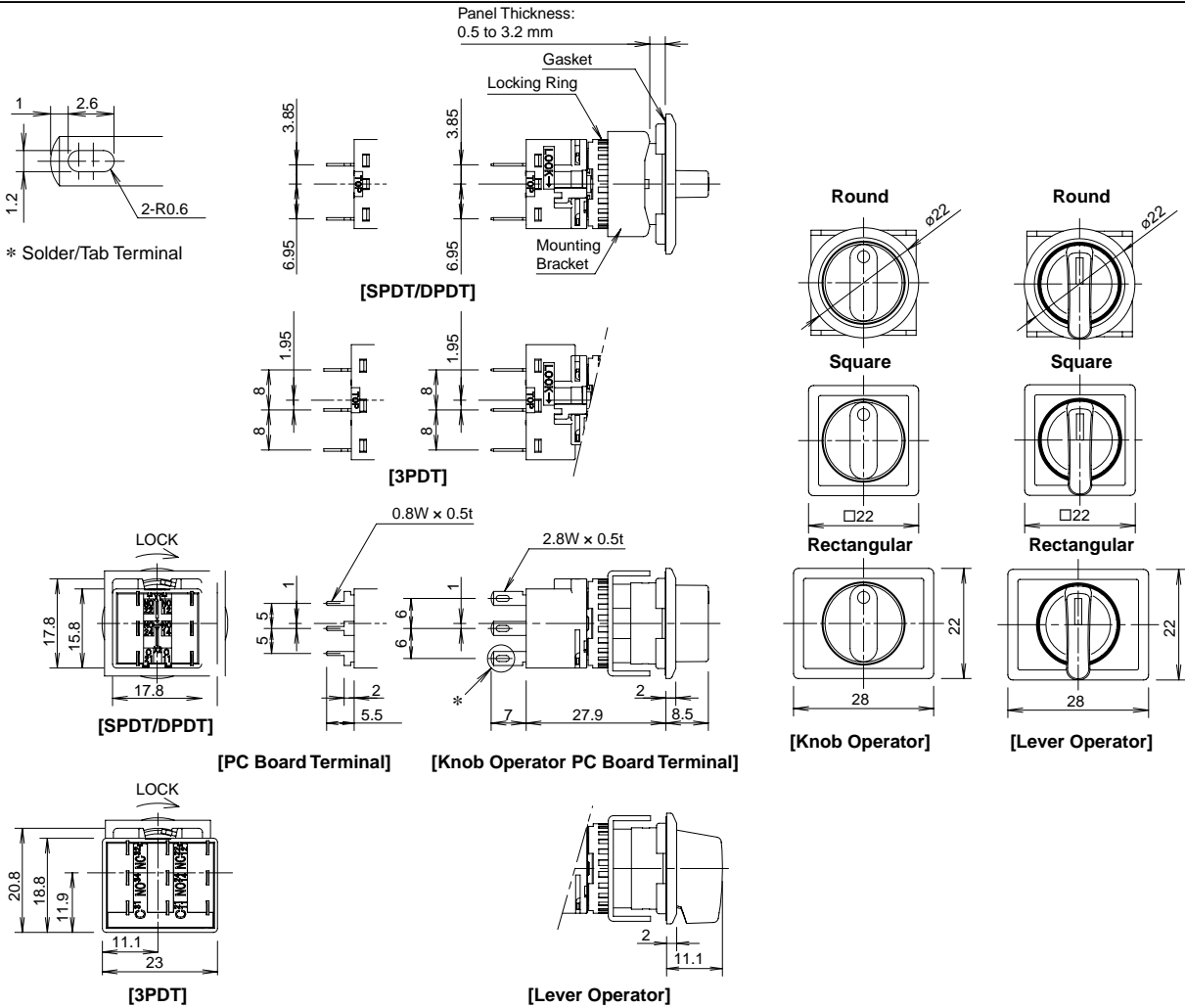

## Terminal Arrangement (Bottom View)

### SPDT/DPDT Contacts

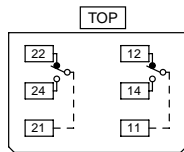

(SPDT contacts on the right only)

### 3PDT Contacts

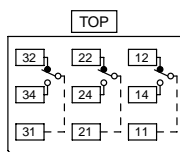

All dimensions in mm.

## Mounting Hole Layout

### Round (LB6/LB6M)

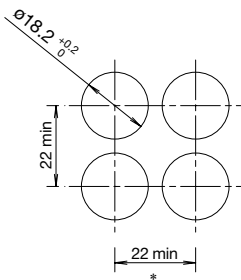

### Square (LB7/LB7M)

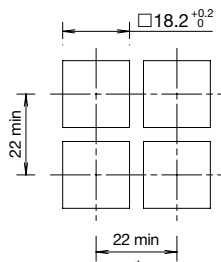

### Rectangular (LB8/LB8M)

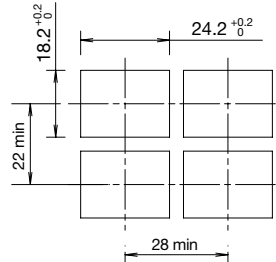

\*: 23.2 mm minimum for 3PDT

Note: When using rubber boot or terminal cover, see dimensions on page 58.

- For details on pc board and circuit design, see page 50.
- For details on single board mounting, see page 51.





Illuminated Pushbutton
Pilot Light
Pushbutton
<b>Selector</b>
Illuminated Selector
Key Selector
Lever Switch
Buzzer
Accessories
Maintenance Parts
Panel Cut-out
Instructions

# Flush Silhouette Switches LB series Illuminated Selector Switches

## Illuminated Selector Switches

Solder/Tab Terminal

Package Quantity:1

Part No. / Shape	LB①F-②T③④⑤*							
	 Round / Black Bezel			 Square / Black Bezel				
① Shape	② Operator Position		③ Contact	④ LED Operating Voltage	Part No.		* Illumination Color Code	
					Gold Contact	Silver Contact		
Black bezel	90° 2-position	Maintained 	SPDT	24V AC/DC	LB①F-2T14*	LB①F-2T54*	Specify the color code in place of * in the Part No.  G: green R: red W: white	
			DPDT	24V AC/DC	LB①F-2T24*	LB①F-2T64*		
Metallic bezel	45° 3-position	Maintained 	DPDT	24V AC/DC	LB①F-3T24*	LB①F-3T64*		

- Illuminated selector switches contain an LED unit. For maintenance LED units see page 60.
- PC board terminals available for gold contacts. To specify, see Part Number Development below.
- 5V DC and 12V AC/DC LED operating voltages also available. To specify, see Part Number Development below.
- For contact operation, see page 48.



### Part Number Development

LB①F-②T③④⑤\*

#### ① Shape

Code	Shape
6	Round / Black Bezel
6M	Round / Metallic Bezel

#### ② Operator Position

Operator Position	
2-position	3-position
2 Maintained 	3 Maintained 

#### ③ Contacts

Code	Contact
1	Gold/SPDT (90° 2-position only)
2	Gold/DPDT
5	Silver/SPDT (90° 2-position only)
6	Silver/DPDT

#### ④ LED Operating Voltage

Code	Rated Operating Voltage
1	5V DC
3	12V AC/DC
4	24V AC/DC

#### ⑤ Others

Code	Specification	Part No. Example
Blank	Solder/Tab Terminal	—
V	PC Board Terminal (Gold Contact Only)	LB6F-2T14V*

- Specify a color code in place of \* in the Part No.



# Flush Silhouette Switches LB Series Illuminated Selector Switches

## Dimensions

Flush Silhouette LB Series
Flush Silhouette LBW Series
ø16 LB Series
UP Series

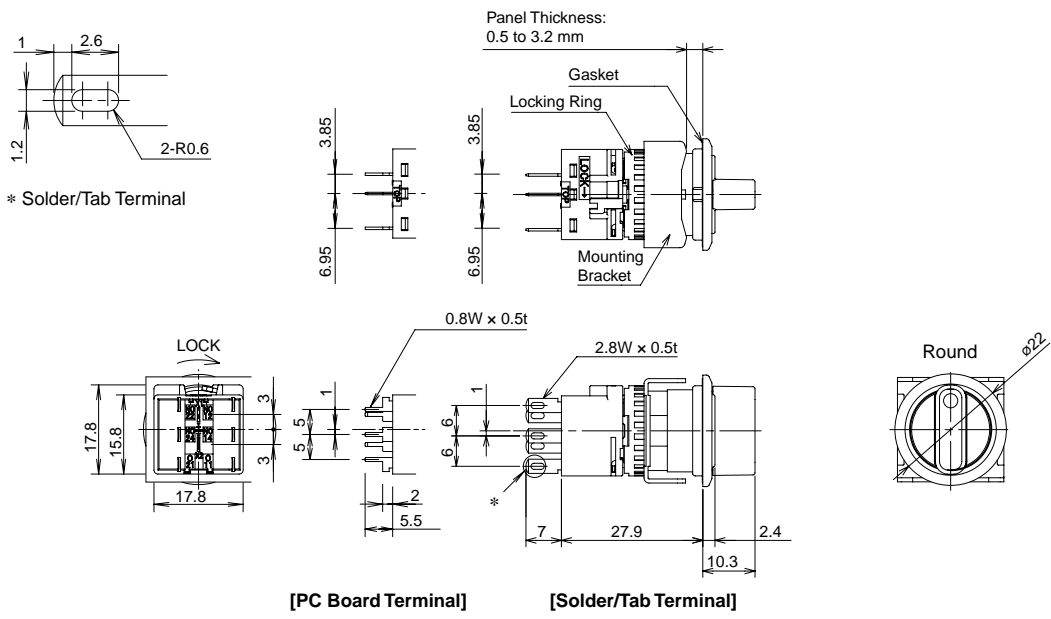

All dimensions in mm.

## Terminal Arrangement (Bottom View)

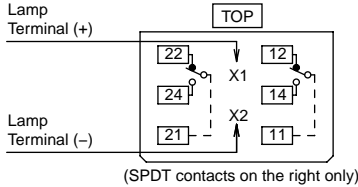

## Mounting Hole Layout

### Round (LB6/LB6M)

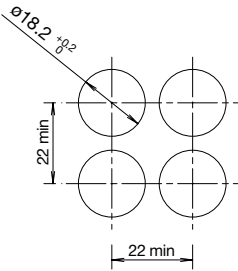

Note: When using terminal cover, see dimensions on page 58.

- For details on pc board and circuit design, see page 50.
- For details on single board mounting, see page 51.

Illuminated Pushbutton
Pilot Light
Pushbutton
Selector
<b>Illuminated Selector</b>
Key Selector
Lever Switch
Buzzer
Accessories
Maintenance Parts
Panel Cut-out
Instructions

# Flush Silhouette Switches LB Series Key Selector Switches

## Key Selector Switches

Solder/Tab Terminal

Package Quantity: 1

Part No. / Shape	LB ① K-② ③ T④ ⑤ -⑥										
	 Round / Black Bezel		 Square / Black Bezel		 Rectangular / Black Bezel		 Round / Metallic Bezel		 Square / Metallic Bezel		 Rectangular / Metallic Bezel
① Shape	② Operator Position		⑤ Key Removable Position	④ Contact	Part No.						
					Gold Contact	Silver Contact					
Black bezel	90° 2-position	Maintained	A: Key removable in all positions	SPDT	LB①K-2ST1A	LB①K-2ST5A					
				DPDT	LB①K-2ST2A	LB①K-2ST6A					
				3PDT	LB①K-2ST3A	LB①K-2ST7A					
	45° 3-position	Maintained	A: Key removable in all positions	DPDT	LB①K-3ST2A	LB①K-3ST6A					
				3PDT	LB①K-3ST3A	LB①K-3ST7A					
Metallic bezel	90° 2-position	Maintained	A: Key removable in all positions	SPDT	LB①K-2ST1A	LB①K-2ST5A					
				DPDT	LB①K-2ST2A	LB①K-2ST6A					
				3PDT	LB①K-2ST3A	LB①K-2ST7A					
	45° 3-position	Maintained	A: Key removable in all positions	DPDT	LB①K-3ST2A	LB①K-3ST6A					
				3PDT	LB①K-3ST3A	LB①K-3ST7A					

- For operator position, see Part Number Development below.
- For key removable position, see Part Number Development below. The key cannot be removed at the return position.
- Two keys are supplied.
- Besides the standard key (key number 0H), six other keys are available. To specify, see Part Number Development below.
- Disc tumbler keys also available. Only the standard key is available. To specify, see Part Number Development below.
- PC board terminals available for gold contacts. To specify, see Part Number Development below.
- For contact operation, see page 48.
- Other bezel sizes available (LBW series). For details, see page 32.

## Part Number Development

LB ① K-② ③ T④ ⑤ -⑥

### ① Shape

Code	Shape
6	Round / Black Bezel
7	Square / Black Bezel
8	Rectangular / Black Bezel
6M	Round / Metallic Bezel
7M	Square / Metallic Bezel
8M	Rectangular / Metallic Bezel

### ② Operator Position

Code	Operator Position
2	90° 2-position maintained
21	90° 2-position spring return from right
3	45° 3-position maintained
31	45° 3-position spring return from right
32	45° 3-position spring return from left
33	45°-3-position spring return two-way

### ③ Key Style

Code	Key Style
S	Wave key
Blank	Disc tumbler key

### ⑤ Key Number

Code	Key Number
Blank	Standard key (0H)
1H to 2H	Reversible key
3H to 6H	Non-reversible key

- Wave key only.

### ④ Contacts

Code	Contact
1	Gold/SPDT (90° 2-position only)
2	Gold/DPDT
3	Gold/3PDT
5	Silver/SPDT (90° 2-position only)
6	Silver/DPDT
7	Silver/3PDT

### ⑤ Key Removal Position

2-position

Key Removal Position		
A: Key removable in all positions	B: Key removable at left	C: Key removable at right

3-position

Key Removal Position			
A: Key removable in all positions	B: Key removable at left / center	C: Key removable at center / right	D: Key removable at center
E: Key removable at right / left	G: Key removable at left	H: Key removable at right	

- Key is removable at ①, ②, ③. Key is retained at ④, ⑤, and ⑥.

For key selectors with the following operations, the key cannot be removed at the return position.

2-position

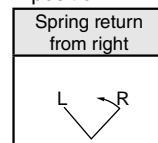

3-position

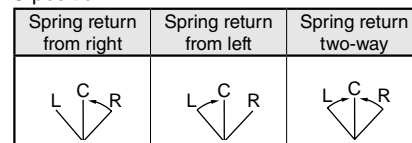

### Others

Code	Specification	Part No. Example
Blank	Solder/Tab Terminal	—
V	PC Board Terminal (Gold Contact Only)	LB6K-2ST1VA

# Flush Silhouette Switches LB Series Key Selector Switches

## Dimensions

Flush Silhouette  
LB Series  
Flush Silhouette  
LBW Series  
ø16  
LB Series  
UP Series

### Key Selector Switches with Wave Key

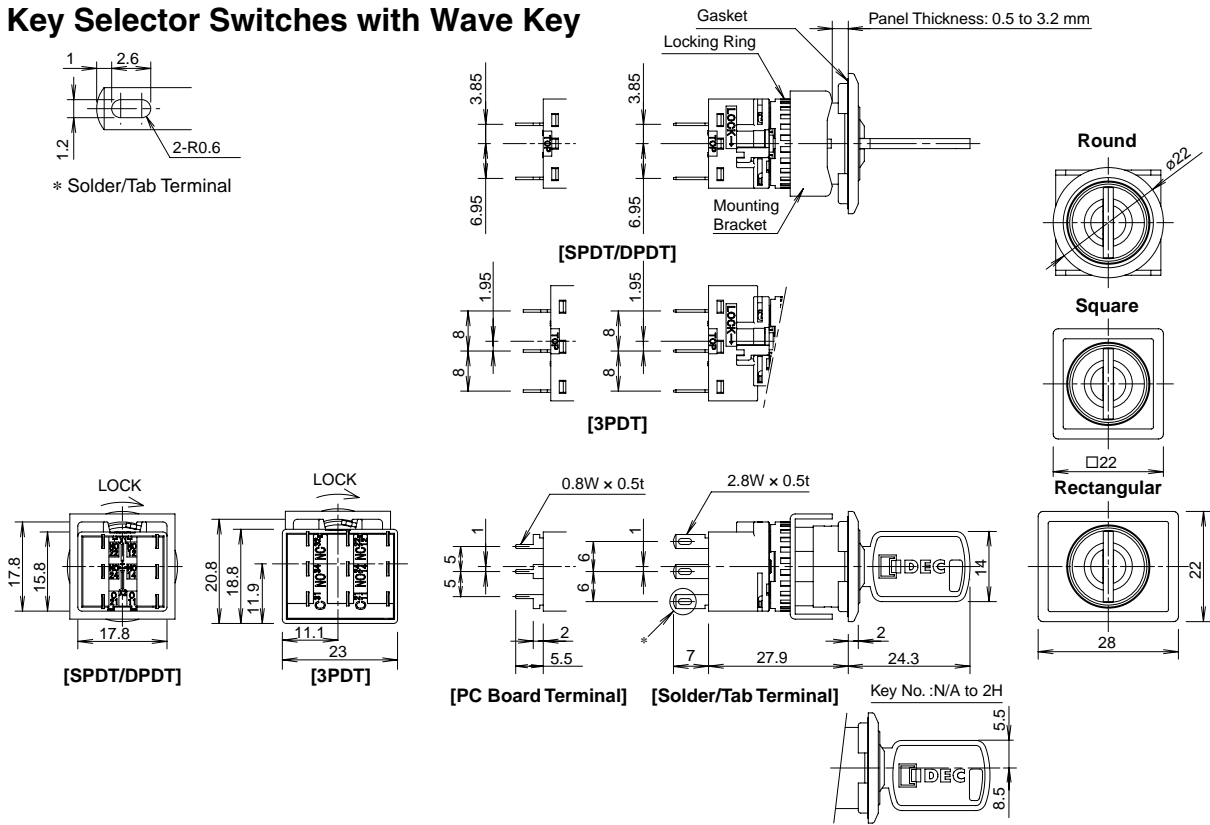

### Key Selector Switches with Disc Tumbler Key

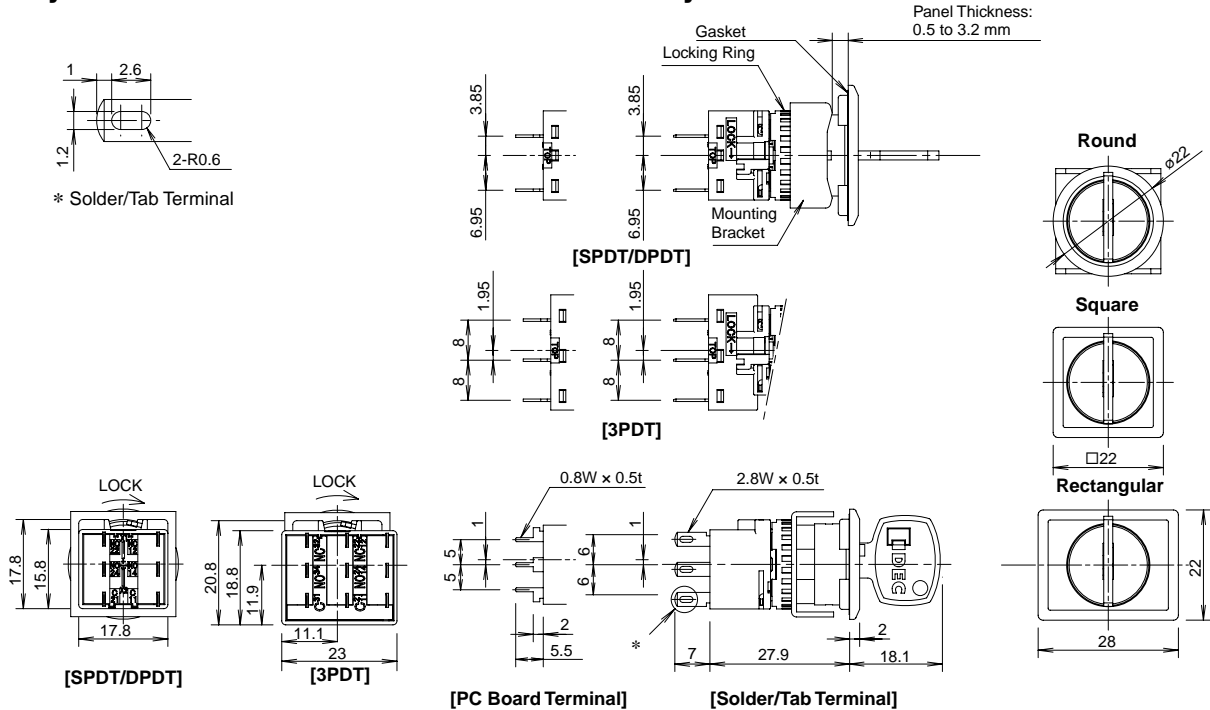

Illuminated  
Pushbutton  
Pilot Light  
Pushbutton  
Selector  
Illuminated  
Selector  
**Key Selector**  
Lever Switch  
Buzzer  
Accessories  
Maintenance  
Parts  
Panel  
Cut-out  
Instructions

### Terminal Arrangement (Bottom View)

#### SPDT/DPDT Contacts

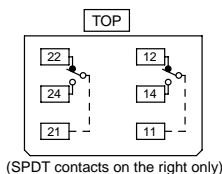

#### 3PDT Contacts

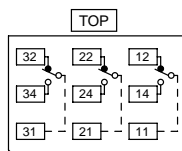

- For details on mounting hole layout, see page 49.
- For details on pc board and circuit design, see page 50.
- For details on single board mounting, see page 51.

All dimensions in mm.



# Flush Silhouette Switches LB Series Lever Switches

## Lever Switches

Solder/Tab Terminal

Package Quantity: 1

Part No. / Shape	 Round / Black Bezel	
---------------------	--	---

Shape	Operator Position		Contact	Part No.	
				Gold Contact	Silver Contact
Black bezel	2-position	Maintained 	SPDT	<b>LB6T-2T1</b>	<b>LB6T-2T5</b>
			DPDT	<b>LB6T-2T2</b>	<b>LB6T-2T6</b>
			3PDT	<b>LB6T-2T3</b>	<b>LB6T-2T7</b>
	3-position	Maintained 	DPDT	<b>LB6T-3T2</b>	<b>LB6T-3T6</b>
			3PDT	<b>LB6T-3T3</b>	<b>LB6T-3T7</b>
			Spring return from top/bottom 	DPDT	<b>LB6T-33T2</b>
		3PDT	<b>LB6T-33T3</b>	<b>LB6T-33T7</b>	

- PC board terminals available for gold contacts. Add "V" to the Part No.  
Example: **LB6T-2T1V**
- For contact operation, see page 48.

# Flush Silhouette Switches LB Series Lever Switches

Flush Silhouette LB Series
Flush Silhouette LBW Series
ø16 LB Series
UP Series

## Dimensions

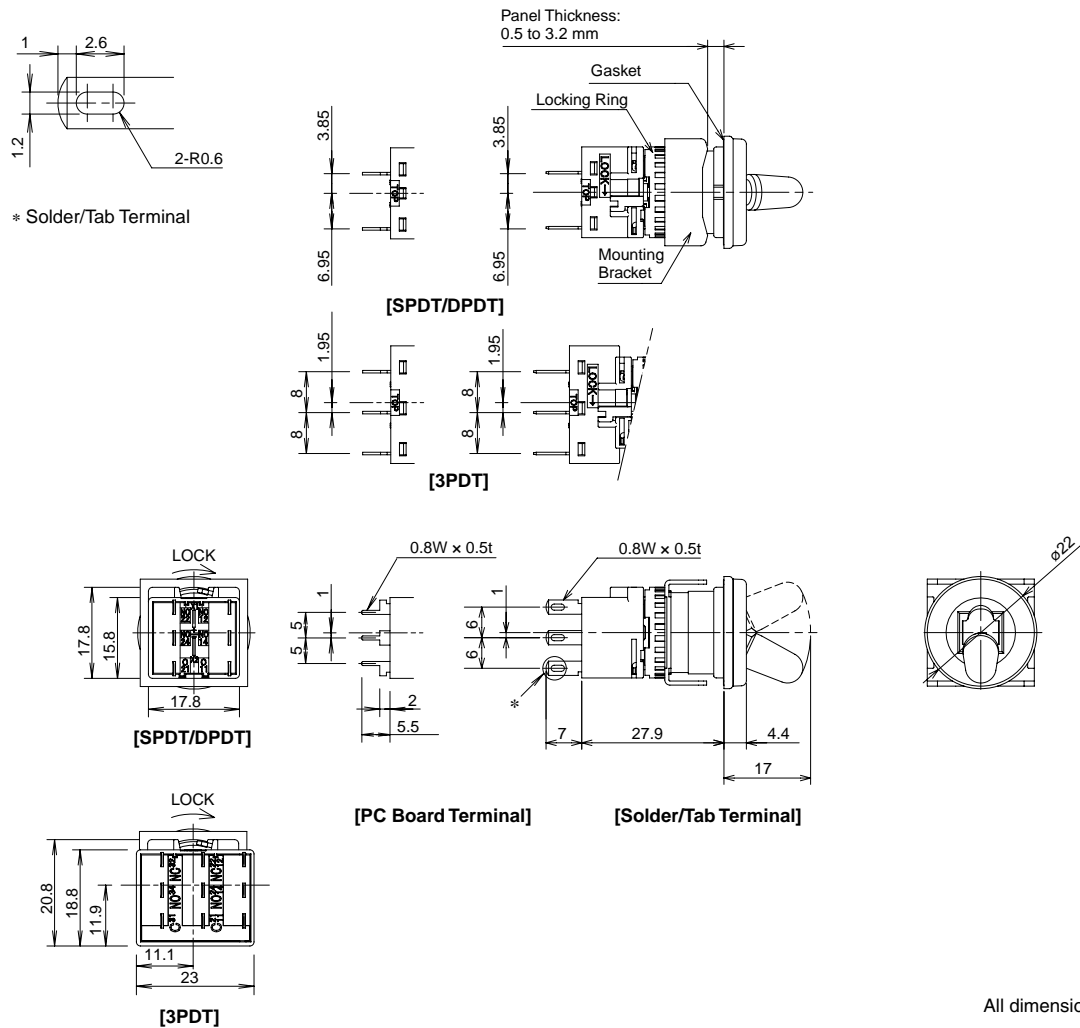

All dimensions in mm.

Illuminated Pushbutton
Pilot Light
Pushbutton
Selector
Illuminated Selector
Key Selector
<b>Lever Switch</b>
Buzzer
Accessories
Maintenance Parts
Panel Cut-out
Instructions

## Terminal Arrangement (Bottom View)

### SPDT/DPDT Contacts

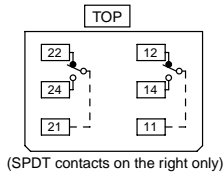

### 3PDT Contacts

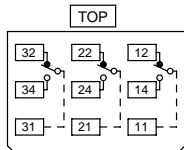

## Mounting Hole Layout

### Round (LB6)

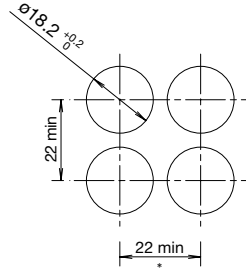

\*: 23.2 mm minimum for 3PDT  
Note: When using terminal cover, see dimensions on page 58.

- For details on pc board and circuit design, see page 50.
- For details on single board mounting, see page 51.

# Flush Silhouette Switches LB Series Buzzers

## Buzzers

### Specifications

Rated Insulation Voltage	30V
Rated Operating Voltage	12, 24V DC
Operating Voltage Range	12V DC±10%, 24V DC±10%
Current Draw	26 mA
Inrush Current	80 mA maximum
Sound Pressure (at 0.1m)	Steady sound: 80 dB minimum (at the rated voltage)
Sound Frequency	2.3±0.3kHz
Response Speed	50 ms maximum
Operating Temperature	-25 to +60°C (no freezing)
Storage Temperature	-30 to +80°C(no freezing)
Operating Humidity	45 to 85% (no condensation)
Insulation Resistance	100 MΩ minimum (500V DC megger)
Dielectric Strength	Between live and dead parts: 1,000V AC, 1 minute
Vibration Resistance	Operating extremes/Damage limits: 5 to 55 Hz, amplitude 0.5 mm
Shock Resistance	Operating extremes: 100m/s <sup>2</sup> Damage limits: 1,000m/s <sup>2</sup>
Life	1,000 hours minimum (beep sound)
Degree of Protection	IP54 (IEC60529)
Terminal Style	Solder/tab terminal #110 PC board terminal
Weight (approx.)	13g (round), 14g (square)

### Standards

Safety Standards	Mark	File No. or Organization
UL60947-1 UL60947-4-1A		UL Recognition File No.E68961
CSA C22.2 No.14		CSA File No.LR21451
EN60947-5-1 EN61000-6-4		EMC Directive

• UL, CSA ratings: Operating voltage 12, 24V DC.

Package Quantity: 1

Part No. / Shape					
		 Round / Black Bezel    Rectangular / Black Bezel    Round / Metallic Bezel    Rectangular / Metallic Bezel			
Shape	Operating Voltage	Degree of Protection	Part No.		
			Terminal Style		
			Solder/tab terminal	PC board terminal	
Black bezel	Round	24V DC	IP54	<b>LB6Z-1T04</b>	<b>LB6Z-1T04V</b>
	Rectangular	24V DC	IP54	<b>LB8Z-1T04</b>	<b>LB8Z-1T04V</b>
Metallic bezel	Round	24V DC	IP54	<b>LB6MZ-1T04</b>	<b>LB6MZ-1T04V</b>
	Rectangular	24V DC	IP54	<b>LB8MZ-1T04</b>	<b>LB8MZ-1T04V</b>

• 12V DC operating voltages also available. Specify "-1T04" in place of "-1T03" in the Part No.  
Example: **LB6Z-1T03**

# Flush Silhouette Switches LB Series Buzzers

## Dimensions

Flush Silhouette  
LB Series

Flush Silhouette  
LBW Series

ø16  
LB Series

UP Series

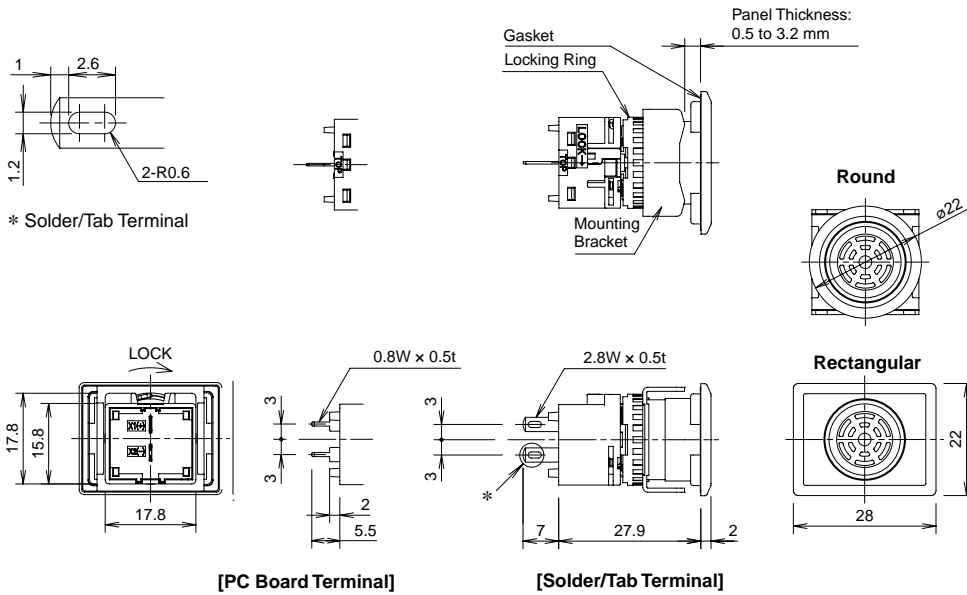

All dimensions in mm.

## Terminal Arrangement (Bottom View)

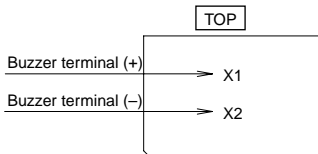

## Mounting Hole Layout

### Round (LB6/LB6M)

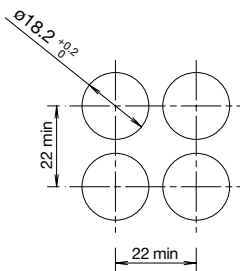

### Rectangular (LB8/LB8M)

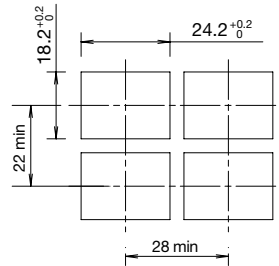

Note: When using rubber boot or terminal cover, see dimensions on page 57 and 58.

- For details on pc board and circuit design, see page 50.
- For details on single board mounting, see page 51.

Illuminated  
Pushbutton

Pilot Light

Pushbutton

Selector

Illuminated  
Selector

Key Selector

Lever Switch

**Buzzer**

Accessories

Maintenance  
Parts

Panel  
Cut-out

Instructions

# Flush Silhouette Switches LBW series Illuminated Pushbuttons

## Illuminated Pushbuttons

Solder/Tab Terminal

Package Quantity: 1

Part No. / Shape	LBW①L-②③T④⑤⑥*							
	<div style="border: 1px solid black; padding: 2px; display: inline-block; margin-bottom: 5px;">Flush</div> 							
① Shape	② Operation	④ Contact	⑤ LED Operating Voltage	Part No.	* Illumination Color Code			
Black bezel	Momentary	Gold/SPDT	24V AC/DC	LBW①L-M③T14*	Specify the color code in place of * in the Part No.  A: amber G: green PW: pure white R: red S: blue W: white Y: yellow			
		Gold/DPDT		LBW①L-M③T24*				
	Maintained	Gold/SPDT	24V AC/DC	LBW①L-A③T14*				
		Gold/DPDT		LBW①L-A③T24*				
Metallic bezel	Momentary	Gold/SPDT	24V AC/DC	LBW①L-M③T14*				
		Gold/DPDT		LBW①L-M③T24*				
	Maintained	Gold/SPDT	24V AC/DC	LBW①L-A③T14*				
		Gold/DPDT		LBW①L-A③T24*				
Guard Type	Momentary	Gold/SPDT	24V AC/DC	LBW①L-M③T14*				
		Gold/DPDT		LBW①L-M③T24*				
	Maintained	Gold/SPDT	24V AC/DC	LBW①L-A③T14*				
		Gold/DPDT		LBW①L-A③T24*				

- Flush/Extended color code: A (amber), G (green), PW (pure white), R (red), S (blue), W (white), Y (yellow)
- Ring-illuminated color code: PW (pure white), W (white), WA (amber), WG (green), WR (red), WS (blue)
- Illuminated pushbuttons contain an LED unit. For details on LED units, see page 60.
- The guard opens 180 degrees spring-return.
- Illuminated pushbuttons can be used with legend markings. Engraving can be done on a marking plate which is placed in the lens, or a clear film can be printed and placed in the lens. See page 64 for details on the marking plate and film.
- White lens type (when light is off) are available. Clear lens is used instead of colored lens for amber, green, red, and blue illuminated pushbuttons. Amber, green, red, or blue LED units are used. To specify, see Part Number Development below.
- PC board terminals available for gold contacts. Silver contacts also available. To specify, see Part Number Development below.
- Extended style is available. See Part Number Development below (③).
- Flush ring-illuminated style is available. See Part Number Development below (③). Guard is not available with flush ring-illuminated style.
- 5V DC and 12V AC/DC LED operating voltages also available.
- Other bezel sizes available (LB series). For details, see page 8.

## Part Number Development

LBW①L-②③T④⑤⑥\*



Extended



Flush Ring-illuminated

### ① Shape

Code	Shape
6	Round / Black Bezel
7	Square / Black Bezel
6M	Round / Metallic Bezel
7M	Square / Metallic Bezel
6G	Round with Guard
7G	Square with Guard

### ② Operation

Code	Operation
A	Maintained
M	Momentary

### ③

Code	Operator Style
1	Flush
2	Extended
1R	Flush Ring-illuminated

### ④ Contacts

Code	Contact
1	Gold/SPDT
2	Gold/DPDT
5	Silver/SPDT
6	Silver/DPDT

### ⑤ LED Operating Voltage

Code	Rated Operating Voltage
1	5V DC
3	12V AC/DC
4	24V AC/DC

### ⑥ Others

Code	Specification	Part No. Example
Blank	Solder/Tab Terminal	—
W	White Lens Type (When Light is Off)	LBW6L-M1T14W*
V	PC Board Terminal (Gold Contact Only)	LBW6L-M1T14V*
VW	White Lens Type (When Light is Off) with PC Board Terminal (Gold Contact Only)	LBW6L-M1T14VW*

- Specify the color code in place of \* in the table above.
- Color code for white lens type (when light is off) : A (amber), G (green), R (red), S (blue)



# Flush Silhouette Switches LBW series Illuminated Pushbuttons

Flush Silhouette  
LB Series

Flush Silhouette  
LBW Series

ø16  
LB Series

UP Series

## Dimensions

### Flush/Ring-illuminated

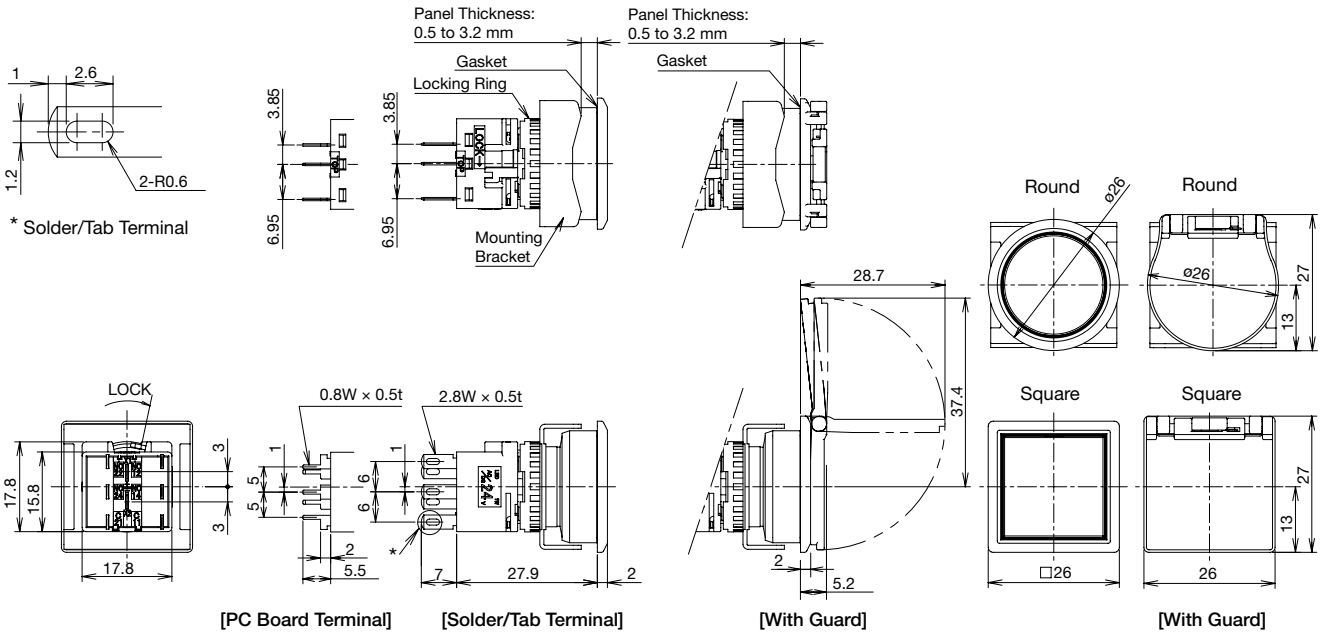

All dimensions in mm.

### Extended

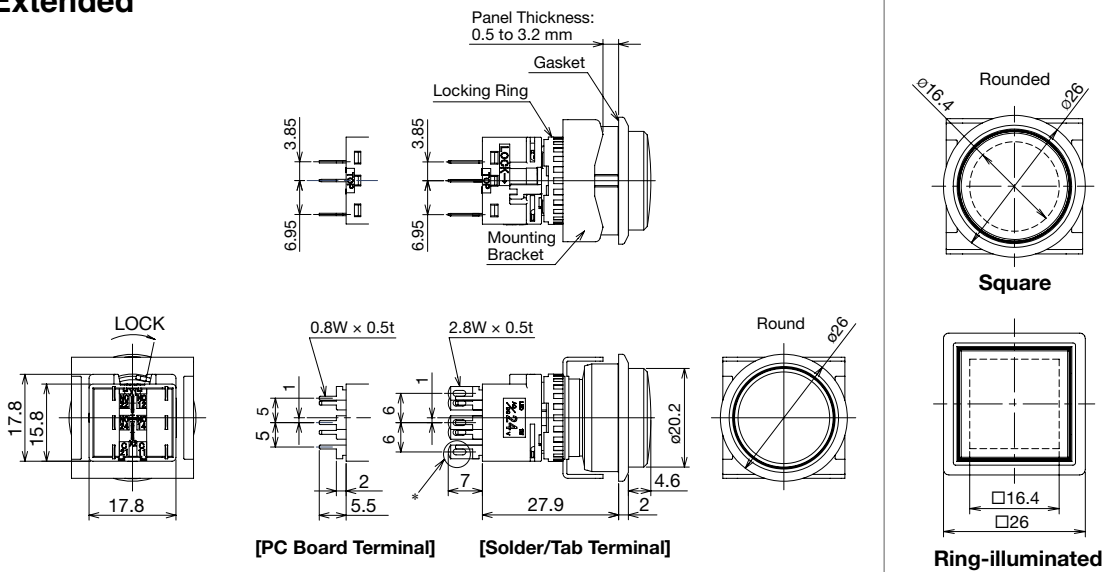

### Terminal Arrangement (Bottom View)

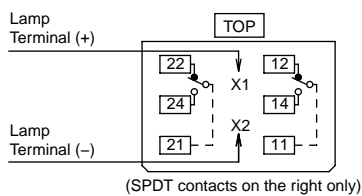

### Mounting Hole Layout

#### Round (LBW6/LBW6M)

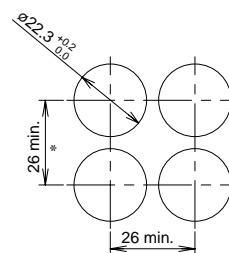

#### Square (LBW7/LBW7M)

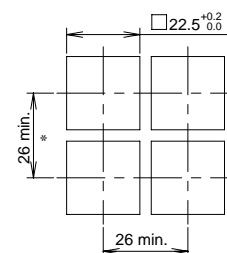

- For details on pc board and circuit design, see page 50.
- For details on single board mounting, see page 51.

\*: 53 mm minimum for switches with guard.

Illuminated  
Pushbutton

Pilot Light

Pushbutton

Selector

Illuminated  
Selector

Key Selector

Lever Switch

Buzzer

Accessories

Maintenance  
Parts

Panel  
Cut-out



Instructions

# Flush Silhouette Switches LBW Series Pilot Lights

## Pilot Lights

### Solder/Tab Terminal

Package Quantity: 1

Part No. / Shape	<b>LBW</b> ① <b>P-1T0</b> ② ③ *	
		
	Round / Black Bezel      Square / Black Bezel      Round / Metallic Bezel      Square / Metallic Bezel	

① Shape	③ LED Operating Voltage	Part No.	* Illumination Color Code
Black Bezel	24V AC/DC	<b>LBW</b> ① <b>P-1T04</b> *	Specify the color code in place of * in the Part No.  A: amber G: green PW: pure white R: red S: blue W: white Y: yellow
Metallic Bezel	24V AC/DC	<b>LBW</b> ① <b>P-1T04</b> *	

- Pilot lights contain an LED unit. For maintenance LED units see page 60.
- White lens type (when light is off) are available. Clear lens is used instead of colored lens for amber, green, red, and blue pilot lights. Amber, green, red, or blue LED units are used. To specify, see Part Number Development below.
- PC board terminals available. To specify, see Part Number Development below.
- 5V DC and 12V AC/DC LED operating voltages also available.
- Other bezel sizes available (LBW series). For details, see page 10.

### Part Number Development

## LBW ① P-1T0 ② ③ \*

#### ① Shape

Code	Shape
6	Round / Black Bezel
7	Square / Black Bezel
6M	Round / Metallic Bezel
7M	Square / Metallic Bezel

#### ④ LED Operating Voltage

Code	Rated Operating Voltage
1	5V DC
3	12V AC/DC
4	24V AC/DC

#### ⑤ Others

Code	Specification	Part No. Example
Blank	Solder/Tab Terminal	—
W	White Lens Type (When Light is Off)	LBW6P-1T04W*
V	PC Board Terminal	LBW6P-1T04V*
VW	White Lens Type (When light is Off) with PC Board Terminal	LBW6P-1T04VW*

- Specify the color code in place of \* in the table above.
- Color code for white lens type: A (amber), G (green), R (red), and S (blue) only.

# Flush Silhouette Switches LBW Series Pilot Lights

Flush Silhouette LB Series
<b>Flush Silhouette LBW Series</b>
ø16 LB Series
UP Series

## Dimensions

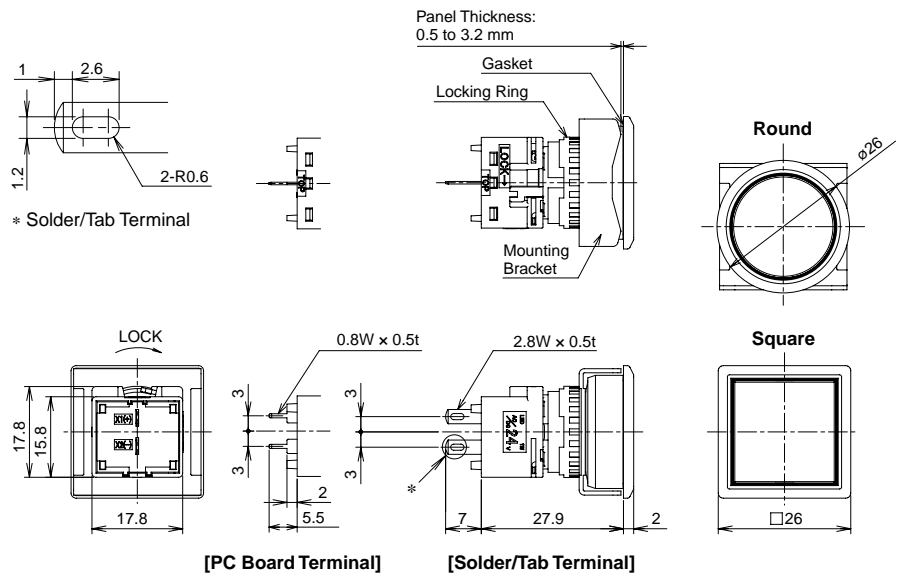

All dimensions in mm.

## Terminal Arrangement (Bottom View)

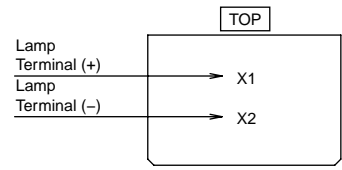

## Mounting Hole Layout

Round (LBW6/LBW6M)

Square (LBW7/LBW7M)

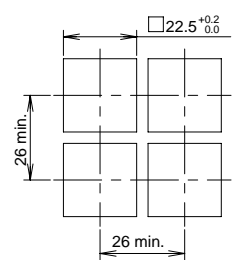
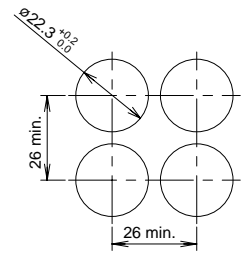

- For details on pc board and circuit design, see page 50.
- For details on single board mounting, see page 51.

Illuminated Pushbutton
<b>Pilot Light</b>
Pushbutton
Selector
Illuminated Selector
Key Selector
Lever Switch
Buzzer
Accessories
Maintenance Parts
Panel Cut-out
Instructions

# Flush Silhouette Switches LBW Series Pushbuttons

## Pushbuttons

Solder/Tab Terminal Package Quantity: 1

Part No. / Shape **LBW** ① **B**-② **1T** ③ ④ \*

Flush Pushbutton

Round / Black Bezel    Square / Black Bezel    Round / Metallic Bezel    Square / Metallic Bezel    Round with Guard    Square with Guard

① Shape	Button Style	② Operation	③ Contact	Part No.		* Illumination Color Code
				Gold Contact	Silver Contact	
Black bezel	Button	Momentary	SPDT	<b>LBW</b> ① <b>B</b> - <b>M1T1</b> *	<b>LBW</b> ① <b>B</b> - <b>M1T5</b> *	Specify the color code in place of * in the Part No.  B: black G: green R: red S: blue W: white Y: yellow
			DPDT	<b>LBW</b> ① <b>B</b> - <b>M1T2</b> *	<b>LBW</b> ① <b>B</b> - <b>M1T6</b> *	
			3PDT	<b>LBW</b> ① <b>B</b> - <b>M1T3</b> *	<b>LBW</b> ① <b>B</b> - <b>M1T7</b> *	
		Maintained	SPDT	<b>LBW</b> ① <b>B</b> - <b>A1T1</b> *	<b>LBW</b> ① <b>B</b> - <b>A1T5</b> *	
			DPDT	<b>LBW</b> ① <b>B</b> - <b>A1T2</b> *	<b>LBW</b> ① <b>B</b> - <b>A1T6</b> *	
			3PDT	<b>LBW</b> ① <b>B</b> - <b>A1T3</b> *	<b>LBW</b> ① <b>B</b> - <b>A1T7</b> *	
Metallic bezel	Button	Momentary	SPDT	<b>LBW</b> ① <b>B</b> - <b>M1T1</b> *	<b>LBW</b> ① <b>B</b> - <b>M1T5</b> *	
			DPDT	<b>LBW</b> ① <b>B</b> - <b>M1T2</b> *	<b>LBW</b> ① <b>B</b> - <b>M1T6</b> *	
			3PDT	<b>LBW</b> ① <b>B</b> - <b>M1T3</b> *	<b>LBW</b> ① <b>B</b> - <b>M1T7</b> *	
		Maintained	SPDT	<b>LBW</b> ① <b>B</b> - <b>A1T1</b> *	<b>LBW</b> ① <b>B</b> - <b>A1T5</b> *	
			DPDT	<b>LBW</b> ① <b>B</b> - <b>A1T2</b> *	<b>LBW</b> ① <b>B</b> - <b>A1T6</b> *	
			3PDT	<b>LBW</b> ① <b>B</b> - <b>A1T3</b> *	<b>LBW</b> ① <b>B</b> - <b>A1T7</b> *	
Guard Type	Button	Momentary	SPDT	<b>LBW</b> ① <b>B</b> - <b>M1T1</b> *	<b>LBW</b> ① <b>B</b> - <b>M1T5</b> *	
			DPDT	<b>LBW</b> ① <b>B</b> - <b>M1T2</b> *	<b>LBW</b> ① <b>B</b> - <b>M1T6</b> *	
			3PDT	<b>LBW</b> ① <b>B</b> - <b>M1T3</b> *	<b>LBW</b> ① <b>B</b> - <b>M1T7</b> *	
		Maintained	SPDT	<b>LBW</b> ① <b>B</b> - <b>A1T1</b> *	<b>LBW</b> ① <b>B</b> - <b>A1T5</b> *	
			DPDT	<b>LBW</b> ① <b>B</b> - <b>A1T2</b> *	<b>LBW</b> ① <b>B</b> - <b>A1T6</b> *	
			3PDT	<b>LBW</b> ① <b>B</b> - <b>A1T3</b> *	<b>LBW</b> ① <b>B</b> - <b>A1T7</b> *	

- The guard opens 180 degrees spring-return.
- PC board terminals available for gold contacts. To specify, see Part Number Development below.
- Pushbuttons can be used with legend markings engraved on marking plates and lens buttons with clear film inserted in the lens is available. To specify, see Part Number Development below. See page 63 for details on the marking plate and film.
- Extended pushbuttons available. To specify, see Part Number Development below. Pushbuttons with guard is not available. Only momentary operation available for square extended pushbuttons.
- Other bezel sizes available (LB series). For details, see page 12.

## Part Number Development

### LBW ① B-② 1T ③ ④ \*

#### ① Shape

Code	Shape
6	Round / Black Bezel
7	Square / Black Bezel
6M	Round / Metallic Bezel
7M	Square / Metallic Bezel
6G	Round with Guard
7G	Square with Guard

#### ② Operation

Code	Operation
A	Maintained
M	Momentary

#### ③ Contacts

Code	Contact	Code	Contact
1	Gold/SPDT	5	Silver/SPDT
2	Gold/DPDT	6	Silver/DPDT
3	Gold/3PDT	7	Silver/3PDT

#### ④ Others

Code	Specification	Part No. Example
Blank	Solder/Tab Terminal	—
L	Lens	LBW6B-M1T1L*
V	PC Board Terminal (Gold Contact Only)	LB6WB-M1T1V*
VL	PC Board Terminal with Lens (Gold Contact Only)	LB6WB-M1T1VL*

#### Extended Pushbutton

Code	Style Example	Part No. Example
2	Extended	LBW6B-M2T1*

- Guard types are not available.
- Round and momentary pushbuttons only.



Photo: extended pushbutton

- Color code (\*) for lens:  
A (amber), B (translucent lens with black nameplate), G (green), R (red), S (blue), W (white), Y (yellow)

# Flush Silhouette Switches LBW Series Pushbuttons

## Dimensions

Flush Silhouette  
LB Series

Flush Silhouette  
LBW Series

ø16  
LB Series

UP Series

All dimensions in mm.

### Flush Pushbutton

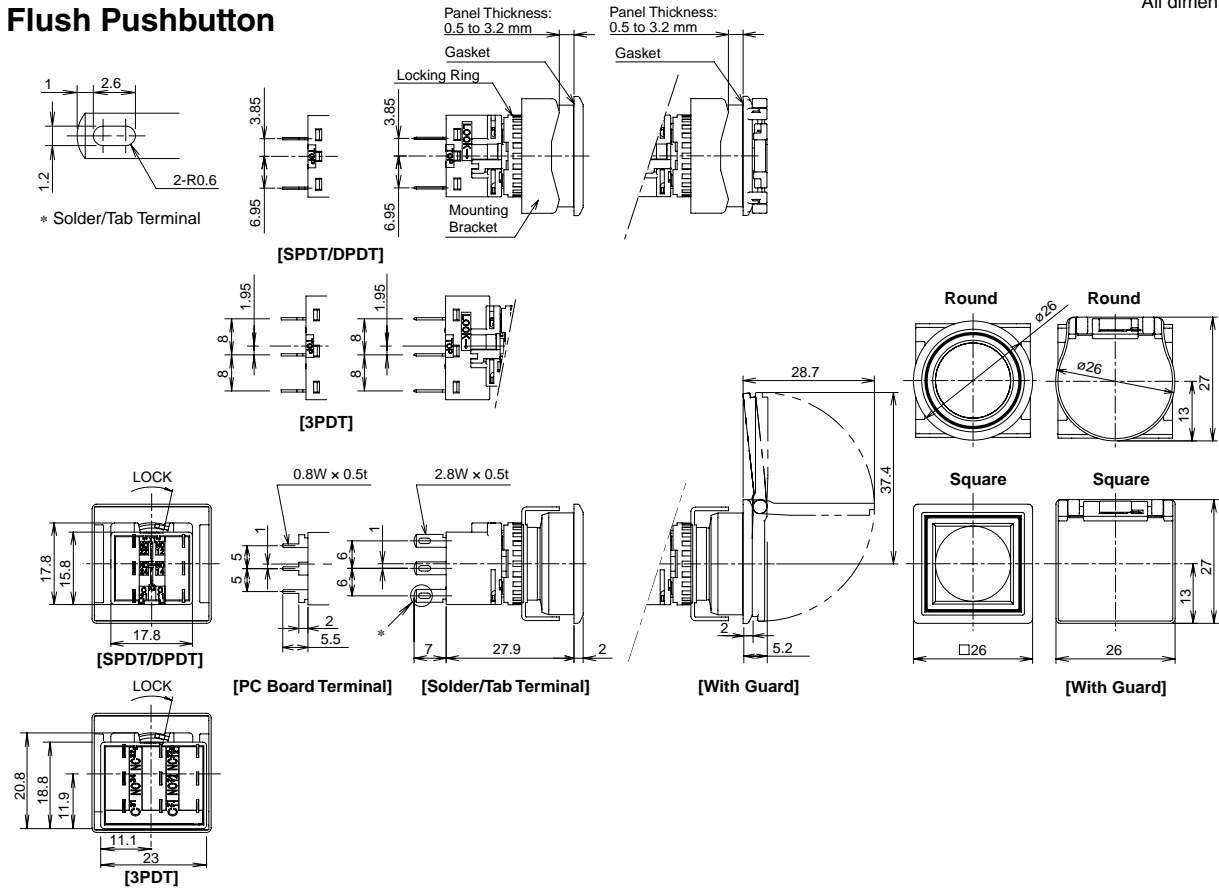

### Extended Pushbutton

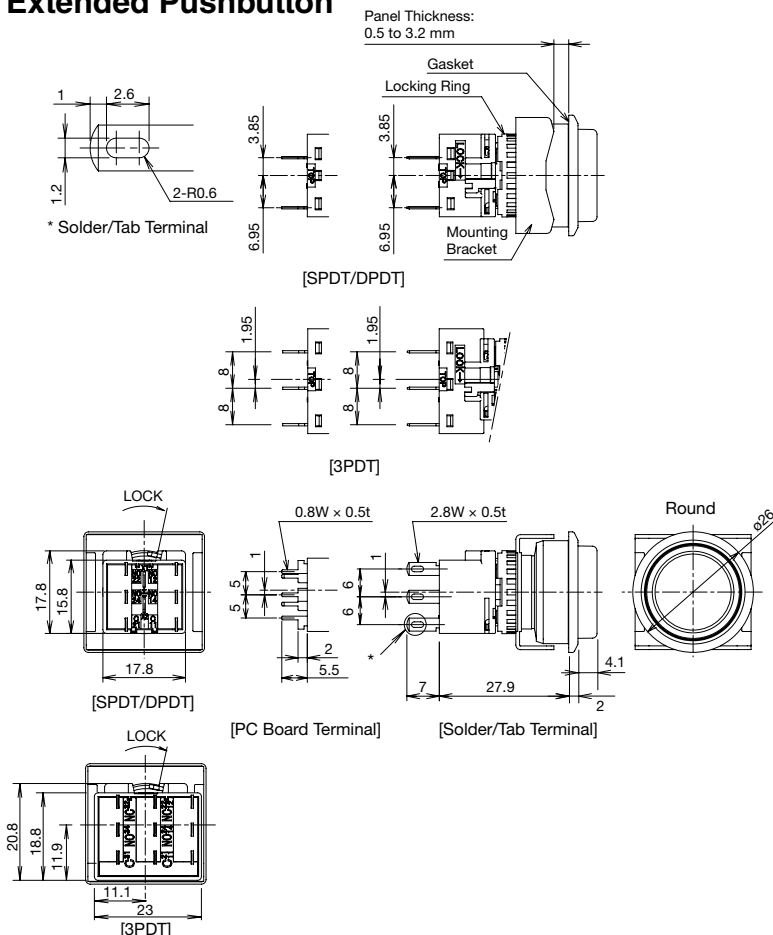

### Terminal Arrangement (Bottom View)

#### SPDT/DPDT Contacts

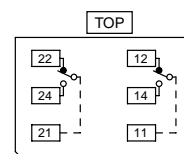

(SPDT contacts on the right only)

#### 3PDT Contacts

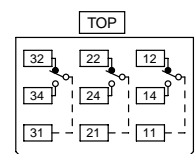

- For details on mounting hole layout, see page 49.
- For details on pc board and circuit design, see page 50.
- For details on single board mounting, see page 51.

Illuminated Pushbutton

Pilot Light

**Pushbutton**

Selector

Illuminated Selector

Key Selector

Lever Switch

Buzzer

Accessories

Maintenance Parts

Panel Cut-out



Instructions

# Flush Silhouette Switches LBW series Selector Switches

## Selector Switches

Solder/Tab Terminal

Package Quantity: 1

Part No. / Shape	<b>LBW</b> ① <b>S</b> -② <b>T</b> ③ ④	
		
	Round / Black Bezel      Square / Black Bezel      Round / Metallic Bezel      Square / Metallic Bezel	

① Shape	② Operator Position	③ Contact	Part No.		
			Gold Contact	Silver Contact	
Black bezel	90° 2-position	Maintained	SPDT	<b>LBW</b> ① <b>S</b> -2 <b>T</b> 1	<b>LBW</b> ① <b>S</b> -2 <b>T</b> 5
			DPDT	<b>LBW</b> ① <b>S</b> -2 <b>T</b> 2	<b>LBW</b> ① <b>S</b> -2 <b>T</b> 6
			3PDT	<b>LBW</b> ① <b>S</b> -2 <b>T</b> 3	<b>LBW</b> ① <b>S</b> -2 <b>T</b> 7
	45° 3-position	Maintained	DPDT	<b>LBW</b> ① <b>S</b> -3 <b>T</b> 2	<b>LBW</b> ① <b>S</b> -3 <b>T</b> 6
			3PDT	<b>LBW</b> ① <b>S</b> -3 <b>T</b> 3	<b>LBW</b> ① <b>S</b> -3 <b>T</b> 7
		Spring return two-way	DPDT	<b>LBW</b> ① <b>S</b> -3 <b>3T</b> 2	<b>LBW</b> ① <b>S</b> -3 <b>3T</b> 6
Metallic bezel	90° 2-position	Maintained	SPDT	<b>LBW</b> ① <b>S</b> -2 <b>T</b> 1	<b>LBW</b> ① <b>S</b> -2 <b>T</b> 5
			DPDT	<b>LBW</b> ① <b>S</b> -2 <b>T</b> 2	<b>LBW</b> ① <b>S</b> -2 <b>T</b> 6
			3PDT	<b>LBW</b> ① <b>S</b> -2 <b>T</b> 3	<b>LBW</b> ① <b>S</b> -2 <b>T</b> 7
	45° 3-position	Maintained	DPDT	<b>LBW</b> ① <b>S</b> -3 <b>T</b> 2	<b>LBW</b> ① <b>S</b> -3 <b>T</b> 6
			3PDT	<b>LBW</b> ① <b>S</b> -3 <b>T</b> 3	<b>LBW</b> ① <b>S</b> -3 <b>T</b> 7
		Spring return two-way	DPDT	<b>LBW</b> ① <b>S</b> -3 <b>3T</b> 2	<b>LBW</b> ① <b>S</b> -3 <b>3T</b> 6
		DPDT	<b>LBW</b> ① <b>S</b> -3 <b>3T</b> 3	<b>LBW</b> ① <b>S</b> -3 <b>3T</b> 7	

- PC board terminals available for gold contacts. To specify, see Part Number Development below.
- For contact operation, see page 48.
- Other bezel sizes available (LB series). For details, see page 14.

## Part Number Development

### LBW ① S-② T ③ ④

#### ① Shape

Code	Shape
6	Round / Black Bezel
7	Square / Black Bezel
6M	Round / Metallic Bezel
7M	Square / Metallic Bezel

#### ② Operator Position

##### 2-position

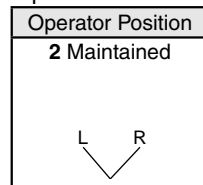

##### 3-position

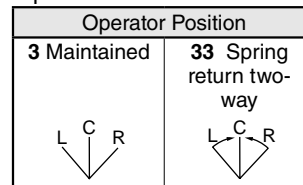

#### ③ Contacts

Code	Contact
1	Gold/SPDT (90° 2-position only)
2	Gold/DPDT
3	Gold/3PDT
5	Silver/SPDT (90° 2-position only)
6	Silver/DPDT
7	Silver/3PDT

#### ④ Others

Code	Specification	Part No. Example
Blank	Solder/Tab Terminal	—
V	PC Board Terminal (Gold Contact Only)	LBW6S-2T1V











# Flush Silhouette Switches LBW series Key Selector Switches

## Key Selector Switches

Solder/Tab Terminal

Package Quantity:1

Part No. / Shape	LBW ① K-② ③ T ④ ⑤ -⑥					
						
① Shape	② Operator Position		⑤ Key Removable Position	⑤ Contact	Part No.	
					Gold Contact	Silver Contact
Black bezel	90° 2-position	Maintained	A: Key removable in all positions 	SPDT	LBW①K-2ST1A	LBW①K-2ST5A
				DPDT	LBW①K-2ST2A	LBW①K-2ST6A
				3PDT	LBW①K-2ST3A	LBW①K-2ST7A
	45° 3-position	Maintained	A: Key removable in all positions 	DPDT	LBW①K-3ST2A	LBW①K-3ST6A
Metallic bezel	90° 2-position	Maintained	A: Key removable in all positions 	SPDT	LBW①K-2ST1A	LBW①K-2ST5A
				DPDT	LBW①K-2ST2A	LBW①K-2ST6A
				3PDT	LBW①K-2ST3A	LBW①K-2ST7A
	45° 3-position	Maintained	A: Key removable in all positions 	DPDT	LBW①K-3ST2A	LBW①K-3ST6A
				3PDT	LBW①K-3ST3A	LBW①K-3ST7A

- For operator position, see Part Number Development below.
- For key removable position, see Part Number Development below. The key cannot be removed at the return position.
- Two keys are supplied.
- Besides the standard key (key number 0H), six other keys are available.
- Disc tumbler keys also available. Only the standard key is available. To specify, see Part Number Development below.
- PC board terminals available for gold contacts. To specify, see Part Number Development below.
- For contact operation, see page 48.
- Other bezel sizes available (LB series). For details, see page 18.

## Part Number Development

LBW ① K-② ③ T ④ ⑤ -⑥

### ① Shape

Code	Shape
6	Round / Black Bezel
7	Square / Black Bezel
6M	Round / Metallic Bezel
7M	Square / Metallic Bezel

### ② Operator Position

Code	Operator Position
2	90° 2-position maintained
3	45° 3-position maintained
33	45°-3-position spring return two-way

Disc Tumbler Key



Photo: metallic bezel

### ③ Key Style



Code	Key Style
S	Wave key
Blank	Disc tumbler key

### ④ Contacts



Code	Contact
1	Gold/SPDT (90° 2-position only)
2	Gold/DPDT
3	Gold/3PDT
5	Silver/SPDT (90° 2-position only)
6	Silver/DPDT
7	Silver/3PDT

### ⑤ Key Removal Position

2-position

Key Removable Position	
A: Key removable in all positions 	B: Key removable at left 

3-position

Key Removable Position	
A: Key removable in all positions 	D: Key removable at left 

- Key is removable at ①, ②, ③. Key is retained at ④, ⑤, and ⑥.

For key selectors with the following operations, the key cannot be removed at the return position.

3-position

Spring return two-way

### ⑥ Key Number

Code	Key Number
0H	Standard key
1H to 2H	Reversible key
3H to 6H	Non-reversible key

- Wave keys only.

### Others

Code	Specification	Part No. Example
Blank	Solder/Tab Terminal	—
V	PC Board Terminal (Gold Contact Only)	LBW6K-2T1VA



# Flush Silhouette Switches LBW series Key Selector Switches

## Dimensions

Flush Silhouette  
LB Series  
Flush Silhouette  
LBW Series  
ø16  
LB Series  
UP Series

### Key Selector Switches with Wave Key

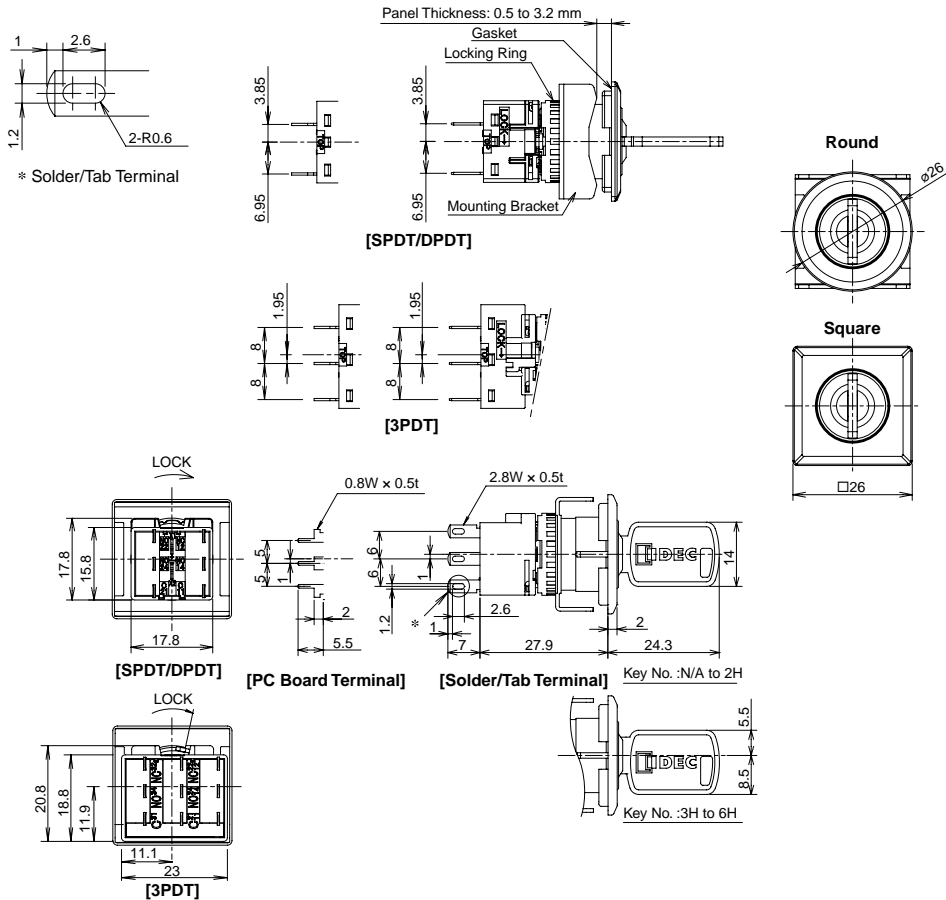

### Key Selector Switches with Disc Tumbler Key

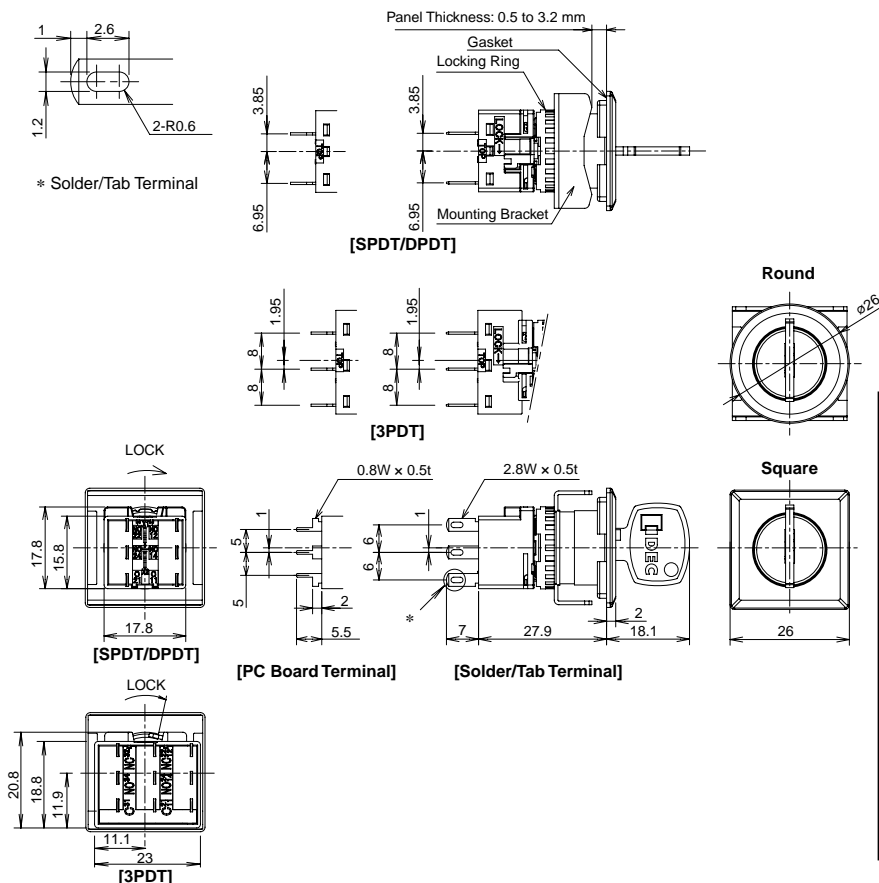

### Terminal Arrangement (Bottom View)

#### SPDT/DPDT Contacts 3PDT Contacts

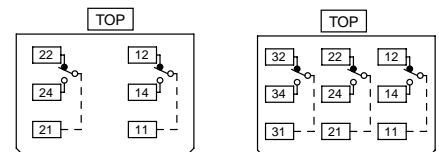

(SPDT contacts on the right only)

- For details on mounting hole layout, see page 49.
- For details on pc board and circuit design, see page 50.
- For details on single board mounting, see page 51.





Illuminated Pushbutton  
Pilot Light  
Pushbutton  
Selector  
Illuminated Selector  
**Key Selector**  
Lever Switch  
Buzzer  
Accessories  
Maintenance Parts  
Panel Cut-out  
Instructions

# ø16 LB Series Illuminated Pushbuttons

## Illuminated Pushbuttons

Solder/Tab Terminal

Package Quantity: 1

Part No. / Shape	LB ① L - ② 1 T ③ ④ ⑤ *				
	 Round  Square  Rectangular  Rectangular with 3-sided Barrier				
② Operation	③ Contact	④ LED Operating Voltage	Part No.		* Illumination Color Code
			Gold Contact	Silver Contact	
Momentary	SPDT	24V AC/DC	LB ① L-M1T14*	LB ① L-M1T54*	Specify the color code in place of * in the Part No. A: amber G: green PW: pure white R: red S: blue W: white Y: yellow
	DPDT		LB ① L-M1T24*	LB ① L-M1T64*	
Maintained	SPDT	24V AC/DC	LB ① L-A1T14*	LB ① L-A1T54*	
	DPDT		LB ① L-A1T24*	LB ① L-A1T64*	

- Illuminated pushbuttons contain an LED unit. For details on LED units, see page 60.
- Illuminated pushbuttons can be used with legend markings. Engraving can be done on a marking plate which is placed in the lens, or a clear film can be printed and placed in the lens. See page 63 for details on the marking plate and film.
- White lens type (when light is off) are available. Clear lens is used instead of colored lens for amber, green, red, and blue illuminated pushbuttons. Amber, green, red, or blue LED units are used. To specify, see Part Number Development below.
- PC board terminals available for gold contacts. To specify, see Part Number Development below.
- 5V DC and 12V AC/DC LED operating voltages also available. To specify, see Part Number Development below.

## Part Number Development

LB ① L - ② 1 T ③ ④ ⑤ \*

### ① Shape

Code	Shape
1	Round
2	Square
3	Rectangular
4	Rectangular with 3-sided Barrier

### ② Operation

Code	Operation
A	Maintained
M	Momentary

### ③ Contacts

Code	Contact
1	Gold/SPDT
2	Gold/DPDT
5	Silver/SPDT
6	Silver/DPDT

### ④ LED Operating Voltage

Code	Rated Operating Voltage
1	5V DC
3	12V AC/DC
4	24V AC/DC

### ⑤ Others

Code	Specification	Part No. Example
Blank	Solder/Tab Terminal	—
W	White Lens Type (When Light is Off)	LB1L-M1T14W*
V	PC Board Terminal (Gold Contact Only)	LB1L-M1T14V*
VW	White Lens Type (When Light is Off) with PC Board Terminal (Gold Contact Only)	LB1L-M1T14VW*

- Specify the color code in place of \* in the table above
- Color code for white lens type: A (amber), G (green), R (red), and S (blue) only.

Flush Silhouette LB Series
Flush Silhouette LBW Series
<b>ø16 LB Series</b>
UP Series

## Dimensions

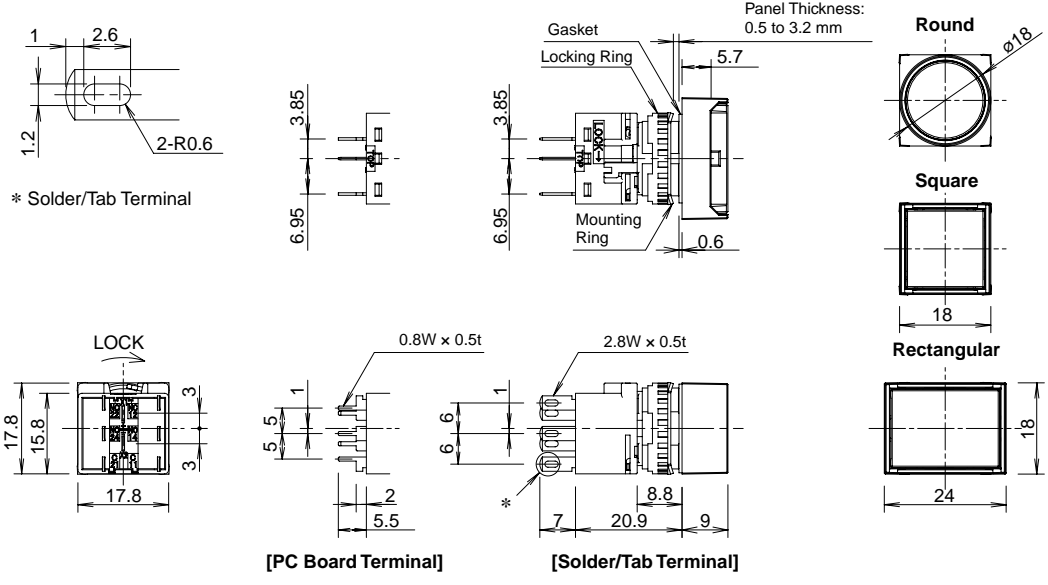

All dimensions in mm.

## Terminal Arrangement (Bottom View)

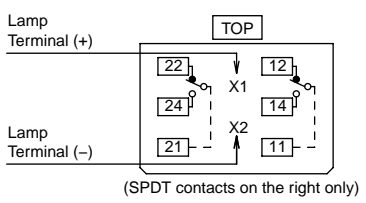

## Mounting Hole Layout

### Round (LB1/LB2/LB3/LB4)

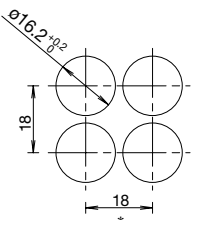

\*: 24 mm for rectangular units.  
 Note: When using rubber boot or terminal cover, see dimensions on 56 and 58.

- For details on pc board and circuit design, see page 50.
- For details on single board mounting, see page 51.





<b>Illuminated Pushbutton</b>
Pilot Light
Pushbutton
Selector
Illuminated Selector
Key Selector
Lever Switch
Buzzer
Accessories
Maintenance Parts
Panel Cut-out
Instructions

# ø16 LB Series Pilot Lights

## Pilot Lights

### Solder/Tab Terminal

Package Quantity: 1

Part No. / Shape	<b>LB①P-②T③④*</b>			
				
	Round	Dome	Square	Rectangular Rectangular with 3-sided Barrier
② Lens Shape	③ LED Operating Voltage	Part No.	* Illumination Color Code	
Flush	24V AC/DC	<b>LB①P-1T④*</b>	Specify the color code in place of * in the Part No.	
Dome	24V AC/DC	<b>LB1P-2T④*</b>	A: amber G: green PW: pure white R: red S: blue W: white Y: yellow	

- Pilot lights contain an LED unit. For maintenance LED units see page 60.
- White lens type (when light is off) are available. Clear lens is used instead of colored lens for amber, green, red, and blue pilot lights. Amber, green, red, or blue LED units are used. To specify, see Part Number Development below.
- PC board terminals available. To specify, see Part Number Development below.
- 5V DC and 12V AC/DC LED operating voltages also available. To specify, see Part Number Development below.

## Part Number Development

### LB①P-②T③④\*

#### ① Shape

Code	Shape
1	Round
2	Square
3	Rectangular
4	Rectangular with 3-sided Barrier

#### ② Lens Shape

Code	Lens Shape
1	Flush
2	Dome

#### ③ LED Operating Voltage

Code	Rated Operating Voltage
1	5V DC
3	12V AC/DC
4	24V AC/DC

- Round only for dome.

#### ⑤ Others

Code	Specification	Part No. Example
Blank	Solder/Tab Terminal	—
W	White Lens Type (When Light is Off)	LB1P-1T04W*
V	PC Board Terminal	LB1P-1T04V*
VW	White Lens Type (When light is Off) with PC Board Terminal	LB1P-1T04VW*

- Specify the color code in place of \* in the table above
- Color code for white lens type: A (amber), G (green), R (red), and S (blue) only.



# ø16 LB Series Pushbuttons

## Pushbuttons

Solder/Tab Terminal

Package Quantity: 1

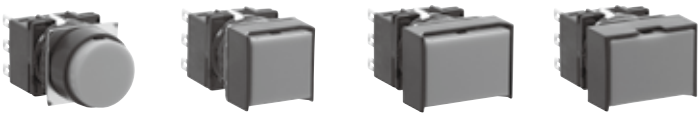
Part No. / Shape	<b>LB①B-②1T③④*</b>	
		
	<p>Round                  Square                  Rectangular                  Rectangular with 3-sided Barrier</p>	

Button Style	② Operation	③ Contact	Part No.		* Illumination Color Code
			Gold Contact	Silver Contact	
Button	Momentary	SPDT	<b>LB①B-M1T1*</b>	<b>LB①B-M1T5*</b>	B: black G: green R: red S: blue W: white Y: yellow
		DPDT	<b>LB①B-M1T2*</b>	<b>LB①B-M1T6*</b>	
		3PDT	<b>LB①B-M1T3*</b>	<b>LB①B-M1T7*</b>	
	Maintained	SPDT	<b>LB①B-A1T1*</b>	<b>LB①B-A1T5*</b>	
		DPDT	<b>LB①B-A1T2*</b>	<b>LB①B-A1T6*</b>	
		3PDT	<b>LB①B-A1T3*</b>	<b>LB①B-A1T7*</b>	
Lens	Momentary	SPDT	<b>LB①B-M1T1L*</b>	<b>LB①B-M1T5L*</b>	A: amber G: green R: red S: blue W: white Y: yellow
		DPDT	<b>LB①B-M1T2L*</b>	<b>LB①B-M1T6L*</b>	
		3PDT	<b>LB①B-M1T3L*</b>	<b>LB①B-M1T7L*</b>	
	Maintained	SPDT	<b>LB①B-A1T1L*</b>	<b>LB①B-A1T5L*</b>	
		DPDT	<b>LB①B-A1T2L*</b>	<b>LB①B-A1T6L*</b>	
		3PDT	<b>LB①B-A1T3L*</b>	<b>LB①B-A1T7L*</b>	

- Lens can be used with legend markings. Engraving can be done on a marking plate which is placed in the lens, or a clear film can be printed and placed in the lens. See page 63 for details on the marking plate and film.
- Black is available for lens. Black lens consists of a transparent lens and a black marking plate. To specify, see Part Number Development below.
- PC board terminals available for gold contacts. To specify, see Part Number Development below.

## Part Number Development

### LB①B-②1T③④\*

#### ① Shape

Code	Shape
1	Round
2	Square
3	Rectangular
4	Rectangular with 3-sided Barrier

#### ② Operation

Code	Operation
A	Maintained
M	Momentary

#### ③ Contacts

Code	Contact
1	Gold/SPDT
2	Gold/DPDT
3	Gold/3PDT
5	Silver/SPDT
6	Silver/DPDT
7	Silver/3PDT

#### ④ Others

Code	Specification	Part No. Example
Blank	Solder/Tab Terminal	—
B	Black Translucent Lens (Lens Only)	LB1B-M1T1LB
V	PC Board Terminal (Gold Contact Only)	LB1B-M1T1V*

Flush Silhouette LB Series
Flush Silhouette LBW Series
<b>ø16 LB Series</b>
UP Series

## Dimensions

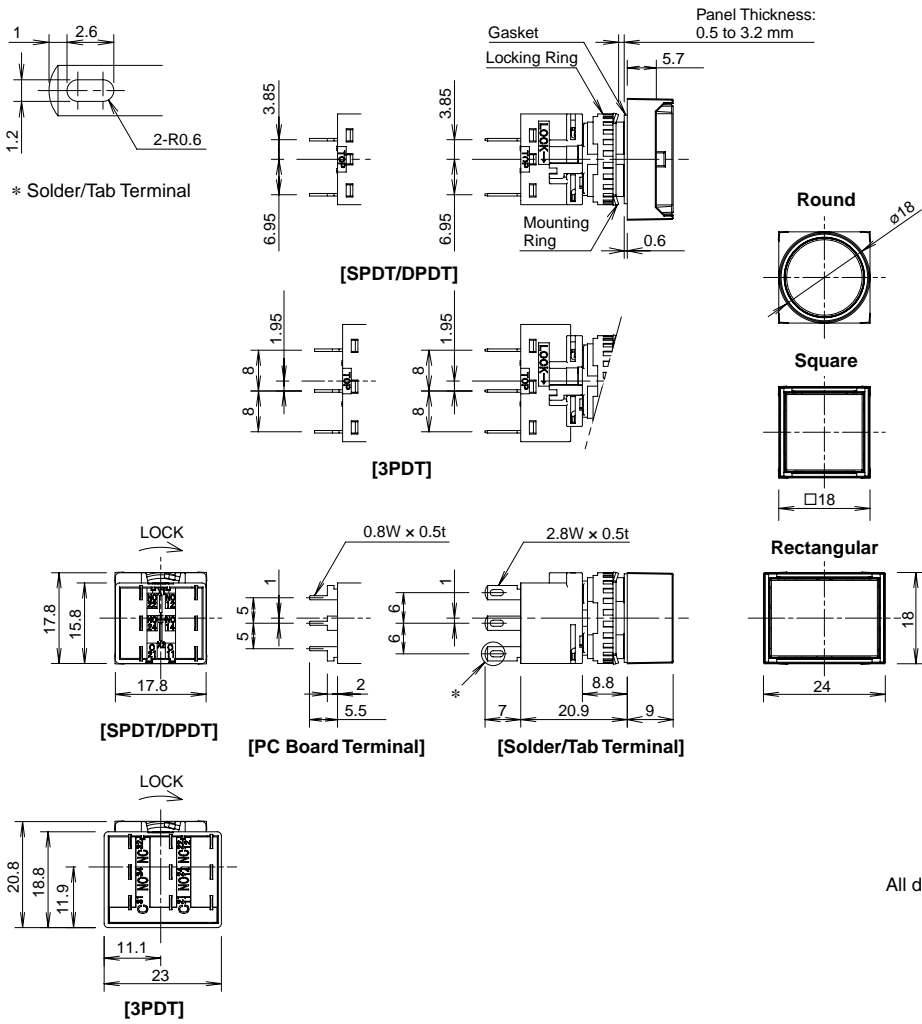

All dimensions in mm.

Illuminated Pushbutton
Pilot Light
<b>Pushbutton</b>
Selector
Illuminated Selector
Key Selector
Lever Switch
Buzzer
Accessories
Maintenance Parts
Panel Cut-out
Instructions

## Terminal Arrangement (Bottom View)

**SPDT/DPDT Contacts**

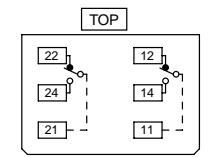

(SPDT contacts on the right only)

**3PDT Contacts**

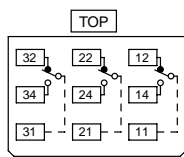

## Mounting Hole Layout

### Round (LB1/LB2/LB3/LB4)

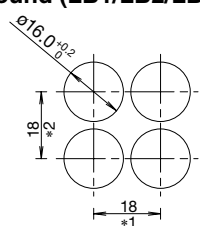

\*1: 24 mm for rectangular units, 23.2 mm for 3PDT  
 \*2: 21 mm for 3PDT

Note: When using rubber boot or terminal cover, see dimensions on 56 and 58.





- For details on pc board and circuit design, see page 50.
- For details on single board mounting, see page 51.

# ø16 LB Series Selector Switches

## Selector Switches

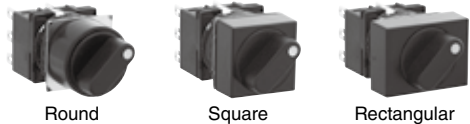
Solder/Tab Terminal

Package Quantity:1

Part No. / Shape	LB①S-②③T④⑤				
	<div style="border: 1px solid black; display: inline-block; padding: 2px;">Knob Operator</div>  Round      Square      Rectangular				
② Operator Position		③ Contact	Part No.		
			Gold Contact		Silver Contact
90° 2-position	Maintained 	SPDT	LB①S-2T1	LB①S-2T5	
		DPDT	LB①S-2T2	LB①S-2T6	
		3PDT	LB①S-2T3	LB①S-2T7	
45° 3-position	Maintained 	DPDT	LB①S-3T2	LB①S-3T6	
		3PDT	LB①S-3T3	LB①S-3T7	
	Spring return two-way 	DPDT	LB①S-33T2	LB①S-33T6	
		3PDT	LB①S-33T3	LB①S-33T7	

- Lever operators also available. To specify, see Part Number Development below.
- PC board terminals available for gold contacts. To specify, see Part Number Development below.
- 2-position spring return from right, 3-position spring return from right, 3-position spring return from left also available. To specify, see Part Number Development below.
- For contact operation, see page 48.



## Part Number Development





LB①S-②③T④⑤

### ① Shape

Code	Shape
1	Round
2	Square
3	Rectangular

### ② Operator Position

2-position Operator Position	
2 Maintained 	21 Spring return from right 

3-position Operator Position			
3 Maintained 	31 Spring return from right 	32 Spring return from left 	33 Spring return two-way 

### ③ Operator

Code	Operator Shape
Blank	Knob
L	Lever

### ④ Contacts

Code	Contact
1	Gold/SPDT (90° 2-position only)
2	Gold/DPDT
3	Gold/3PDT
5	Silver/SPDT (90° 2-position only)
6	Silver/DPDT
7	Silver/3PDT

### ⑤ Others

Code	Specification	Part No. Example
Blank	Solder/Tab Terminal	—
V	PC Board Terminal (Gold Contact Only)	LB1S-2T1V

Lever Operator











# ø16 LB Series Illuminated Selector Switches

## Illuminated Selector Switches

Solder/Tab Terminal

Package Quantity: 1

Part No. / Shape	<b>LB</b> ① <b>F</b> -② <b>T</b> ③ ④ ⑤ *	 <p>Round      Square      Rectangular</p>	
------------------	--	--	---

	② Operator Position	③ Contact	④ LED Operating Voltage	Part No.		* Illumination Color Code
				Gold Contact	Silver Contact	
90° 2-position	Maintained 	SPDT	24V AC/DC	<b>LB</b> ① <b>F</b> -2 <b>T</b> 14*	<b>LB</b> ① <b>F</b> -2 <b>T</b> 54*	Specify the color code in place of * in the Part No. G: green R: red W: white
		DPDT	24V AC/DC	<b>LB</b> ① <b>F</b> -2 <b>T</b> 24*	<b>LB</b> ① <b>F</b> -2 <b>T</b> 64*	
45° 3-position	Maintained 	DPDT	24V AC/DC	<b>LB</b> ① <b>F</b> -3 <b>T</b> 24*	<b>LB</b> ① <b>F</b> -3 <b>T</b> 64*	

- Illuminated selector switches contain an LED unit. For maintenance LED units see page 60.
- PC board terminals available for gold contacts. To specify, see Part Number Development below.
- 5V DC and 12V AC/DC LED operating voltages also available. To specify, see Part Number Development below.
- For contact operation, see page 48.



### Part Number Development

**LB** ① **F**-② **T** ③ ④ ⑤ \*

#### ① Shape

Code	Shape
1	Round
2	Square
3	Rectangular

#### ② Operator Position

Operator Position	
2 Maintained 	3 Maintained 

#### ③ Contacts

Code	Contact
1	Gold/SPDT (90° 2-position only)
2	Gold/DPDT
5	Silver/SPDT (90° 2-position only)
6	Silver/DPDT

#### ④ LED Operating Voltage

Code	Rated Operating Voltage
1	5V DC
3	12V AC/DC
4	24V AC/DC

#### ⑤ Others

Code	Specification	Part No. Example
Blank	Solder/Tab Terminal	—
V	PC Board Terminal (Gold Contact Only)	LB1F-2T14V*

- Specify a color code in place of \* in the Part No.

# LB Series Illuminated Selector Switches ø16

Flush Silhouette LB Series
Flush Silhouette LBW Series
<b>ø16 LB Series</b>
UP Series

## Dimensions

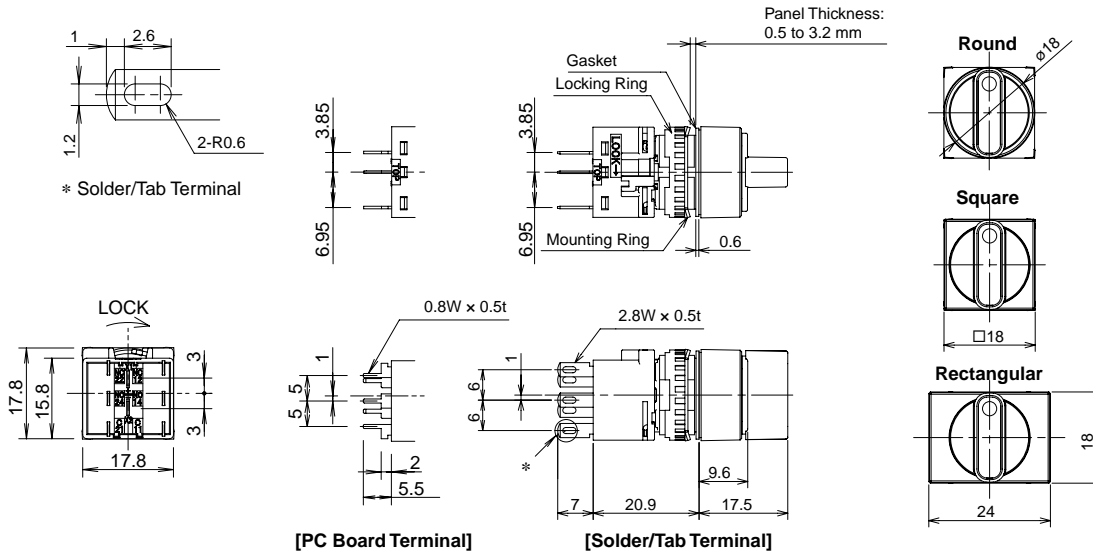

All dimensions in mm.

## Terminal Arrangement (Bottom View)

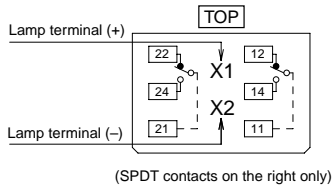

## Mounting Hole Layout

### Round (LB1/LB2/LB3/LB4)

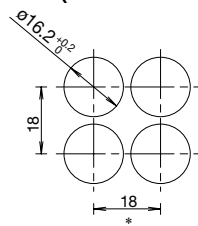

\*: 24 mm for rectangular units.  
 Note: When using terminal cover, see dimensions on page 58.

- For details on pc board and circuit design, see page 50.
- For details on single board mounting, see page 51.

Illuminated Pushbutton
Pilot Light
Pushbutton
Selector
<b>Illuminated Selector</b>
Key Selector
Lever Switch
Buzzer
Accessories
Maintenance Parts
Panel Cut-out
Instructions

# ø16 LB Series Key Selector Switches

## Key Selector Switches

Solder/Tab Terminal

Package Quantity:1

Part No. / Shape	LB ① K-② ③ T ④ ⑤ -⑥			
		Round	Square	Rectangular



② Operator Position	⑤ Key Removable Position	④ Contact	Part No.	
			Gold Contact	Silver Contact
90° 2-position	Maintained 	A: Key removable in all positions SPDT	LB①K-2ST1A	LB①K-2ST5A
		DPDT	LB①K-2ST2A	LB①K-2ST6A
		3PDT	LB①K-2ST3A	LB①K-2ST7A
45° 3-position	Maintained 	A: Key removable in all positions DPDT	LB①K-3ST2A	LB①K-3ST6A
		3PDT	LB①K-3ST3A	LB①K-3ST7A

- For operator position, see Part Number Development below.
- For key removable position, see Part Number Development below. The key cannot be removed at the return position.
- Two keys are supplied.
- Besides the standard key (key number 0H), six other keys are available.
- Disc tumbler keys also available. Only the standard key is available. To specify, see Part Number Development below.
- PC board terminals available for gold contacts. To specify, see Part Number Development below.
- For contact operation, see page 48.

## Part Number Development

### LB ① K-② ③ T ④ ⑤ -⑥

#### ① Shape

Code	Shape
1	Round
2	Square
3	Rectangular

#### ② Operator Position

Code	Operator Position
2	90° 2-position maintained
21	90° 2-position spring return from right
3	45° 3-position maintained
31	45° 3-position spring return from right
32	45° 3-position spring return from left
33	45°-3-position spring return two-way

#### ③ Key Style

Code	Key Style
S	Wave key
Blank	Disc tumbler key

#### ⑥ Key Number

Code	Key Number
Blank	Standard key (0H)
1H to 2H	Reversible key
3H to 6H	Non-reversible key

- Wave key only.

#### ④ Contacts

Code	Contact
1	Gold/SPDT (90° 2-position only)
2	Gold/DPDT
3	Gold/3PDT
5	Silver/SPDT (90° 2-position only)
6	Silver/DPDT
7	Silver/3PDT

#### ⑤ Key Removal Position

##### 2-position

Key Removable Position		
A: Key removable in all positions 	B: Key removable at left 	C: Key removable at right 

##### 3-position

Key Removable Position			
A: Key removable in all positions 	B: Key removable at left / center 	C: Key removable at center / right 	D: Key removable at center 
E: Key removable at right / left 	G: Key removable at left 	H: Key removable at right 	

- Key is removable at ①, ②, ③. Key is retained at ④, ⑤, and ⑥.

For key selectors with the following operations, the key cannot be removed at the return position.

##### 2-position

Spring return from right

##### 3-position

Spring return from right	Spring return from left	Spring return two-way

#### Others

Code	Specification	Part No. Example
Blank	Solder/Tab Terminal	—
V	PC Board Terminal (Gold Contact Only)	LB1K-2ST1VA

## Dimensions

Flush Silhouette LB Series
Flush Silhouette LBW Series
<b>ø16 LB Series</b>
UP Series

### Key Selector Switches with Wave Key

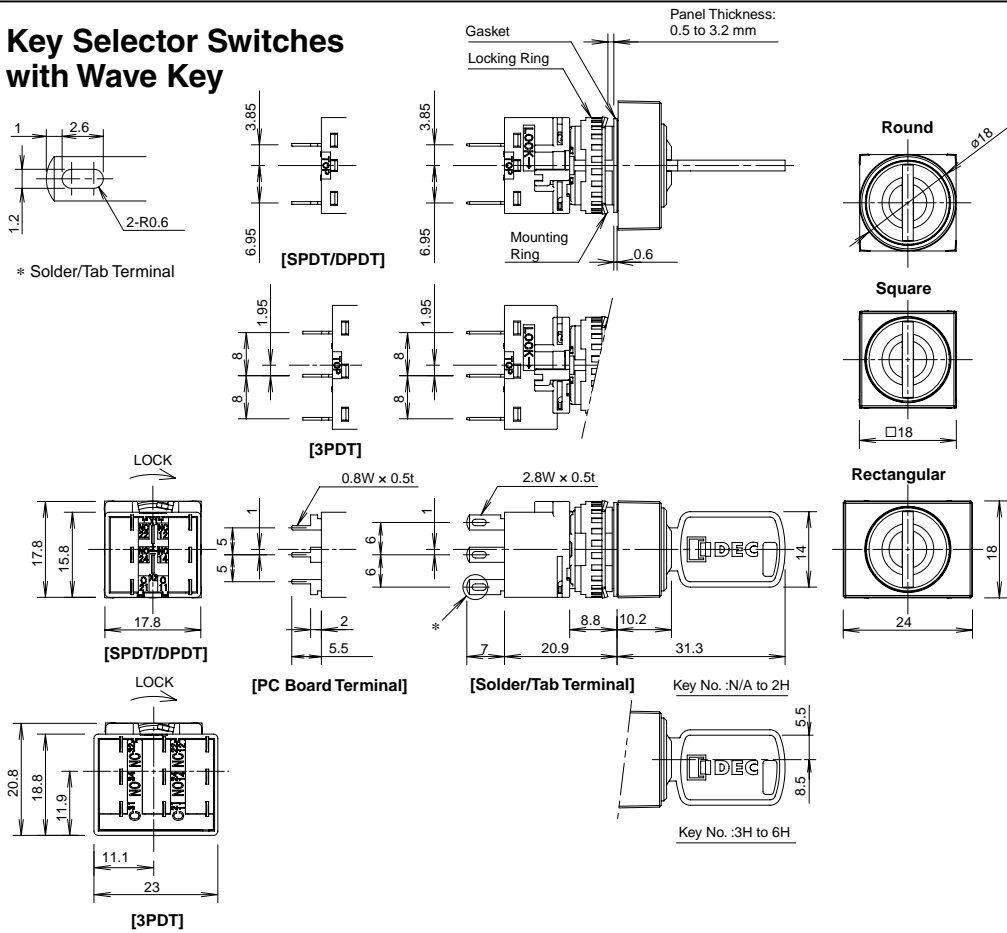

Illuminated Pushbutton
Pilot Light
Pushbutton
Selector
Illuminated Selector
<b>Key Selector</b>
Lever Switch
Buzzer
Accessories
Maintenance Parts
Panel Cut-out
Instructions

### Key Selector Switches with Disc Tumbler Key

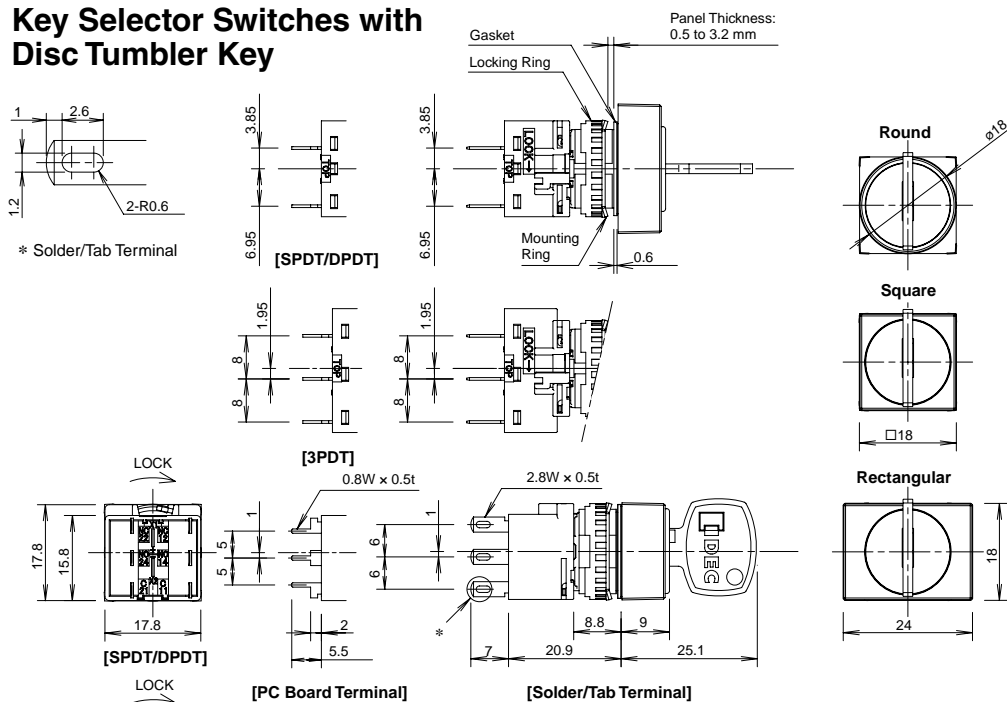

All dimensions in mm.

### Terminal Arrangement (Bottom View)

#### SPDT/DPDT Contacts

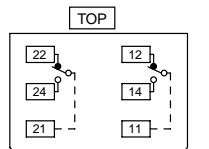

#### 3PDT Contacts

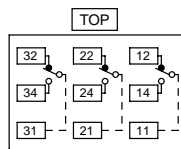





- For details on mounting hole layout, see page 49.
- For details on pc board and circuit design, see page 50.
- For details on single board mounting, see page 51.

# ø16 LB Series Lever Switches

## Lever Switches

Solder/Tab Terminal

Package Quantity:1

Part No. / Shape					
	 Round				
Operator Position		Contact	Part No.		
			Gold Contact	Silver Contact	
2-position	Maintained	 U D	SPDT	<b>LB1T-2T1</b>	<b>LB1T-2T5</b>
			DPDT	<b>LB1T-2T2</b>	<b>LB1T-2T6</b>
			3PDT	<b>LB1T-2T3</b>	<b>LB1T-2T7</b>
3-position	Maintained	 U C D	DPDT	<b>LB1T-3T2</b>	<b>LB1T-3T6</b>
			3PDT	<b>LB1T-3T3</b>	<b>LB1T-3T7</b>
			DPDT	<b>LB1T-33T2</b>	<b>LB1T-33T6</b>
	Spring return from top/bottom	 U C D	DPDT	<b>LB1T-33T2</b>	<b>LB1T-33T6</b>
			3PDT	<b>LB1T-33T3</b>	<b>LB1T-33T7</b>

- PC board terminals available for gold contacts. Add "V" to the Part No.  
Example: **LB1T-2T1V**
- For contact operation, see page 48.

## Dimensions

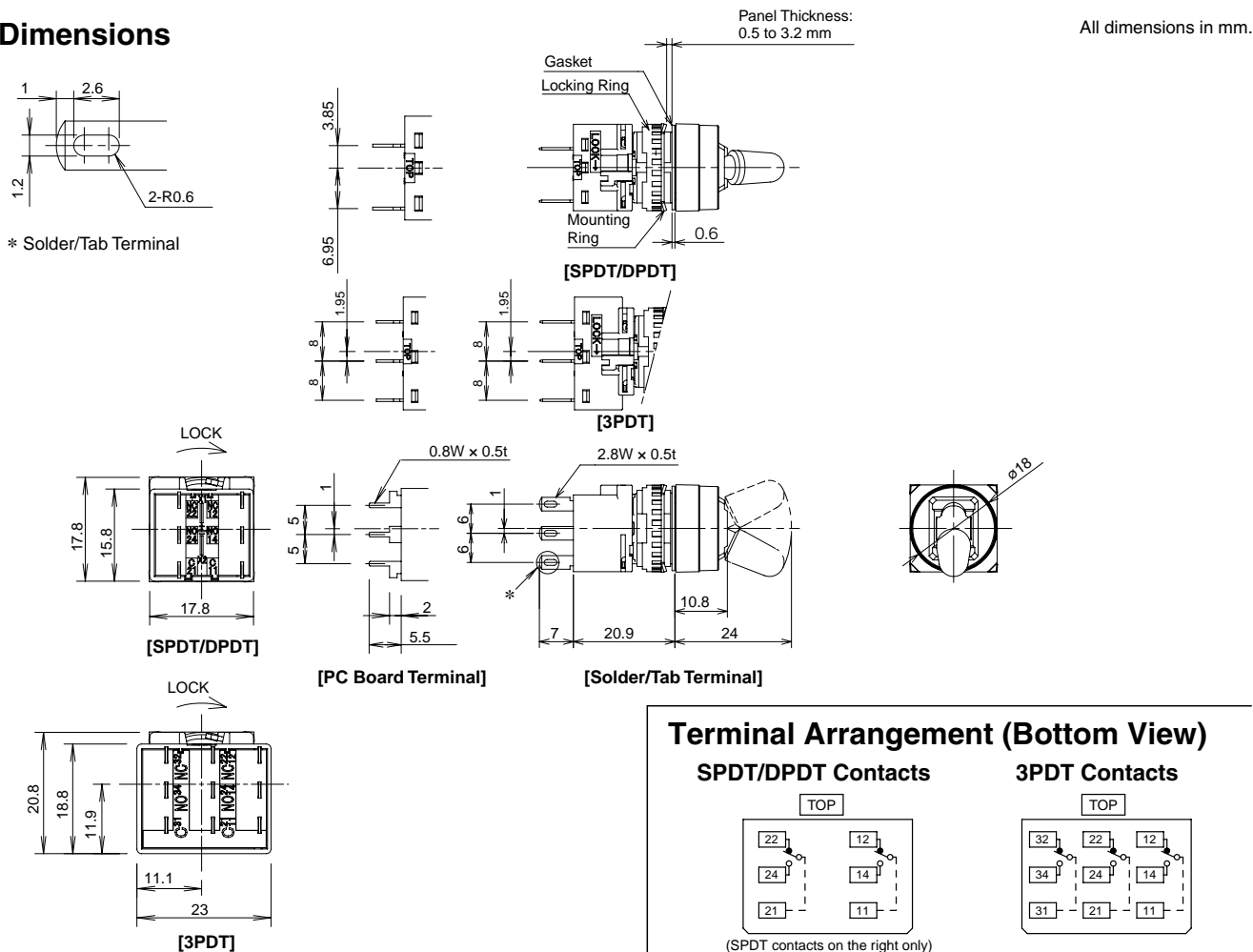



## Buzzers

### Specifications

Rated Insulation Voltage	30V	Dielectric Strength	Between live and dead parts: 1,000V AC, 1 minute
Rated Operating Voltage	12, 24V DC	Vibration Resistance	Operating extremes/Damage limits: 5 to 55 Hz, amplitude 0.5 mm
Operating Voltage Range	12V DC±10%, 24V DC±10%	Shock Resistance	Operating extremes: 100m/s <sup>2</sup> Damage limits: 1,000m/s <sup>2</sup>
Current Draw	26mA	Life	1,000 hours minimum (beep sound)
Inrush Current	80mA maximum	Degree of Protection	LB3Z-1T0*: IP54 (IEC60529) LB3Z-104K: IP40 (IEC60529)
Sound Pressure (at 0.1m)	Steady sound: 80 dB minimum (at the rated voltage)	Terminal Style	LB3Z-1T0*: Solder/tab terminal #110 PC board terminal LB3Z-104K: Solder terminal
Sound Frequency	2.3±0.3kHz	Weight (approx.)	11g (LB3Z-1T0*), 8g (LB3Z-104K)
Response Speed	50 ms maximum		
Operating Temperature	-25 to +60°C (no freezing)		
Storage Temperature	-30 to +80°C (no freezing)		
Operating Humidity	45 to 85% (no condensation)		
Insulation Resistance	100 MΩ minimum (500V DC megger)		

• For applicable standards and UL, CSA ratings, see page 22.

Name and Shape	Operating Voltage	Terminal Style	Part No.	
			IP54	IP40
Rectangular  IP54      IP40 	24V DC	Solder/tab terminal	<b>LB3Z-1T04</b>	—
		PC board terminal	<b>LB3Z-1T04V</b>	—
		Solder terminal	—	<b>LB3Z-104K</b>

• 12V DC operating voltages also available. Specify “-1T04” in place of “-1T03” in the Part No.  
Example: **LB3Z-1T03**

### Dimensions

#### IP54

#### Terminal Arrangement (Bottom View)

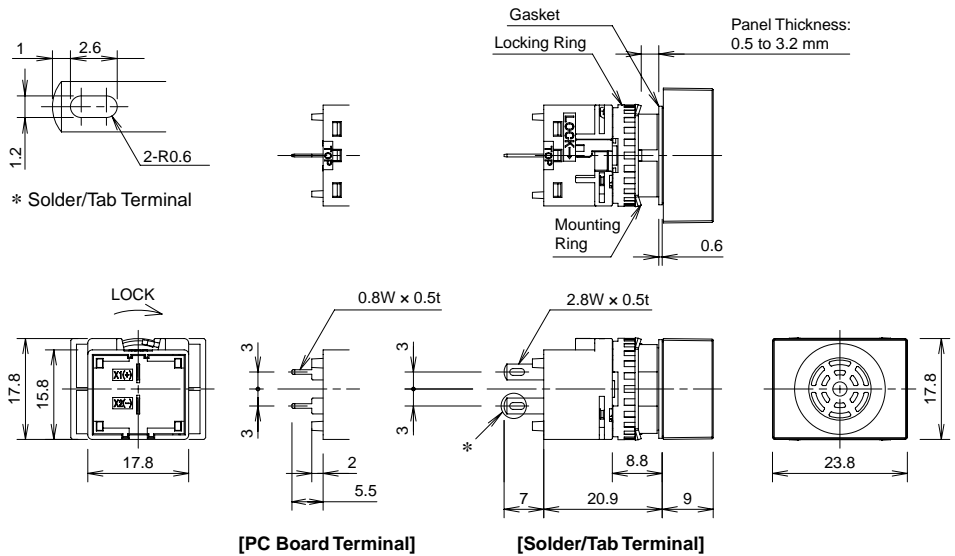
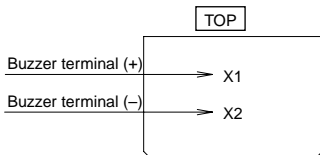

#### IP40

#### Terminal Arrangement (Bottom View)

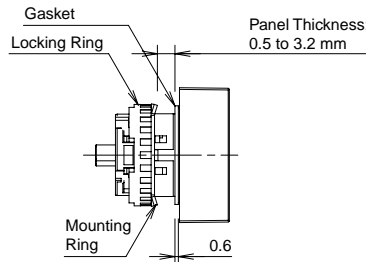
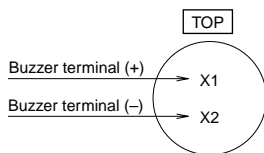

- For details on mounting hole layout, see page 49.
- For details on pc board and circuit design, see page 50.
- For details on single board mounting, see page 51.

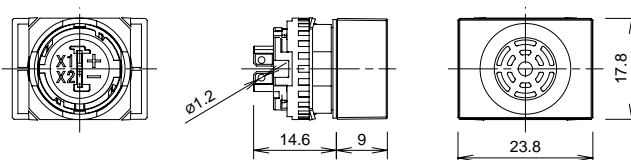

All dimensions in mm.

# LB/LBW Series Contact Operation

## Contact Operation

### Selector Switch / Illuminated Selector Switch / Key Selector Switch

Operator Position & Contact Operation (Top View)					
Position		Contact	↙ Left	↑ Center	↘ Right
90° 2-position	<p>Maintained      Spring return from right</p>	SPDT		/	
		DPDT		/	
		3PDT		/	
45° 3-position	<p>Maintained      Spring return from right      Spring return from left      Spring return two-way</p>	DPDT			
		3PDT			

### Lever Switch

Lever Position & Contact Operation (Top View)					
Position		Contact	Down	Center	Up
90° 2-position	<p>Maintained</p>	SPDT		/	
		DPDT		/	
		3PDT		/	
45° 3-position	<p>Maintained      Spring return two-way</p>	DPDT			
		3PDT			



Flush Silhouette  
LB Series  
Flush Silhouette  
LBW Series  
ø16  
LB Series  
UP Series

## Mounting Hole Layout / PC Board Drilling Layout

### LB Series Flush Bezel

Round (LB6/LB6M)

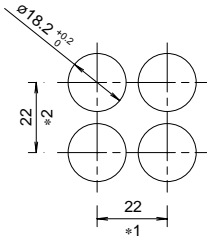

Square (LB7/LB7M)

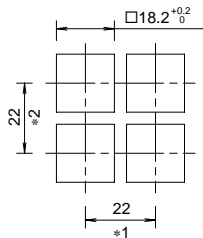

Rectangular (LB8/LB8M)

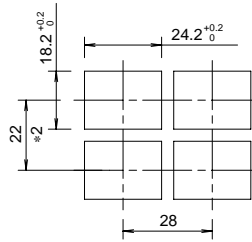

\*1 3PDT: 23.2 mm

\*2 Switches with Guard: 45 mm

Note: When using the LB series with a rubber boot or terminal cover, make sure to note the dimensions on page 56.

### LBW Series Flush Bezel

Round (LBW6/LB6M)

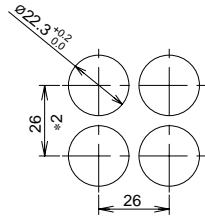

\*53 mm for switches with guard

Square (LBW7/LB7M)

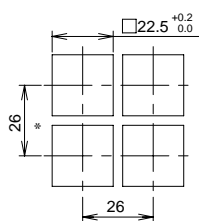

\*53 mm for switches with guard

### LB Series Standard Bezel

(LB1/LB2/LB3/LB4)

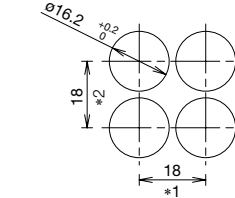

\*1 Rectangular: 24 mm  
3PDT: 23.2 mm  
\*2 3PDT: 21 mm

## Approval Ratings and CCC Approval File No.

### UL

#### Gold Contact

Rated Operating Voltage	30V DC	125V AC
Rated Operating Current	0.1A	0.1A

#### Silver Contact

Rated Operating Voltage		30V	125V	250V	
Rated Operating Current	AC	Res.	—	3.5 A	2, 3, 5A
		Ind.	—	2A	1.5A
	DC	Res.	2, 3, 5A	0.4A	—
		Ind.	1A	0.2A	—

### CSA

#### Gold Contact

Rated Operating Voltage	30V DC	125V DC
Rated Operating Current	0.1A	0.1A

#### Silver Contact

Rated Operating Voltage		30V	125V	250V	
Rated Operating Current	AC	Res.	—	3A	2, 3, 5A
		Ind.	—	2A	1.5A
	DC	Res.	2, 5A	0.4A	—
		Ind.	1A	0.2A	—

### TÜV

#### Gold Contact

Rated Operating Voltage	30V DC	125V AC
Rated Operating Current	0.1A (DC-12)	0.1A (AC-12)

#### Silver Contact

Rated Operating Voltage		30V	125V	250V
Rated Operating Current	AC-12	—	3A	2, 5A
	DC-12	2, 5A	0.4A	—

### CCC

#### Gold Contact

Rated Operating Voltage	30V DC	125V AC
Rated Operating Current	0.1A (DC-12)	0.1A (AC-12)

#### Silver Contact

Rated Operating Voltage		30V	250V
Rated Operating Current	AC-12	—	2, 5A
	DC-12	2, 5A	—

### CCC Approval File No.

Name	Model No.	Safety Standards	CCC Approval File No.
LB Series	LB7	GB14048.5	2012010305561058
	LB6		2012010305561059
	LB1, LB2 LB3, LB4		2012010305561057
	LB8		2012010305561056
LBW Series	LBW6		2012010305533511
	LBW7		2012010305533510

Note: Except pilot light and buzzer.

Illuminated Pushbutton  
Pilot Light  
Pushbutton  
Selector  
Illuminated Selector  
Key Selector  
Lever Switch  
Buzzer  
Accessories  
Maintenance Parts  
Panel Cut-out  
Instructions

# LB/LBW Series Notes for Designing PC Board and Circuit

## Notes for Designing PC Board and Circuit

- Use 1.6-mm-thick glass epoxy PC board with drilled holes.
- Design a circuit so that the LB/LBW series can operate within the rated voltage and current range. Make sure that inrush current and voltage do not exceed the rating.
- Minimum applicable load is 5V AC/DC, 1 mA on gold contacts. Applicable range is subject to the operating condition and load.
- Since the \*2.8-mm-wide terminal touches the PC board as shown on the right, short circuit may occur with pattern lines. Design a circuit that prevents short circuits.

### SPDT/DPDT Contacts

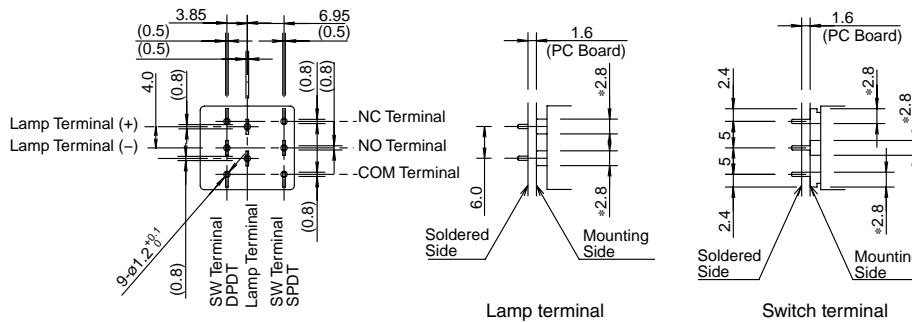

### 3PDT Contacts

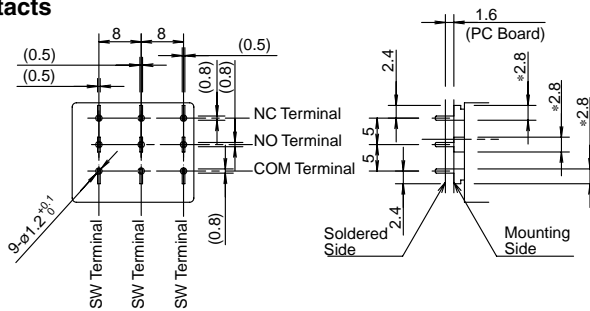

## PC Board Drilling Layout (Bottom View)

### SPDT/DPDT Contacts

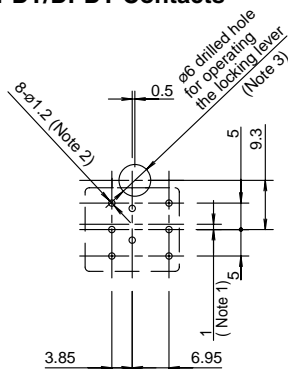

### 3PDT Contacts

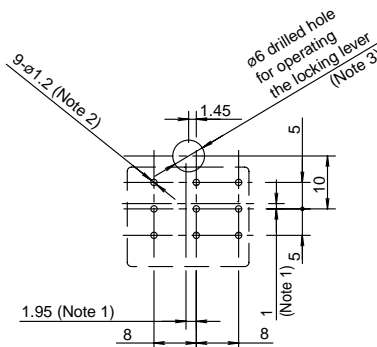

Note 1: When designing, note the alignment of center lines of the contact blocks and center lines of the operators.

Note 2: The diameter of the terminal hole is  $\phi 1.2$ .

Note 3: Hole diameter may vary to meet installation requirements. Determine the location and the size of the hole so that the locking lever can be operated.

All dimensions in mm.

## Single Board Mounting

IDEC's LB/LBW Series is available for single board mounting.

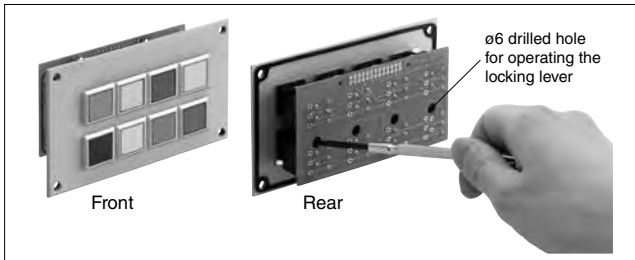

### Installing and Removing Contact Blocks

Turn the locking lever to install and remove contact blocks on the PC using a screwdriver from a hole in the PC board. See "Notes for Designing PC Board and Circuit" on page 50. Determine the location of the switches so that the locking lever can be operated. See "Removing and Installing the Contact Block" on page 61.

### Mounting Holes and Assembly Procedure

Drill mounting holes in the panel as shown below. When the units are mounted collectively, provide adequate clearance.

#### Panel Cut-out for Positioning

##### Standard Bezel (LB1/LB2/LB3/LB4)

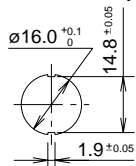

##### LBW Series Flush Bezel (LBW6/LBW6M)

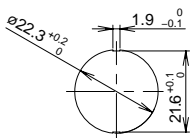

##### LB Series Flush Bezel (LB6/LB6M)

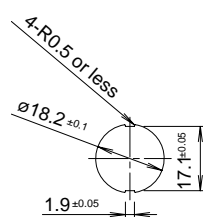

#### Mounting Hole Layout

##### Standard Bezel (LB1/LB2/LB3/LB4)

###### SPDT/DPDT Contacts

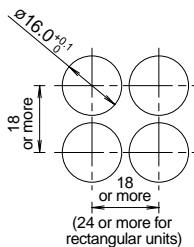

###### 3PDT Contacts

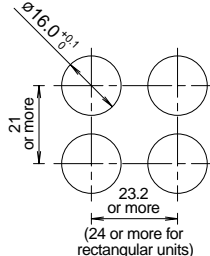

##### LB Series Flush Bezel SPDT/DPDT Contacts LB6/LB6M

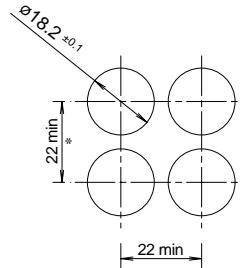

##### 3PDT Contacts

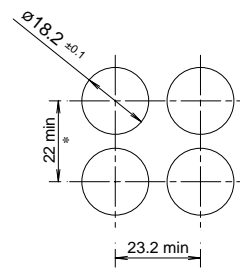

##### LB7/LB7M

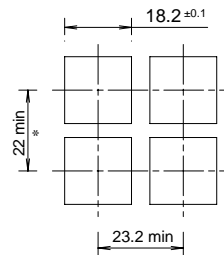
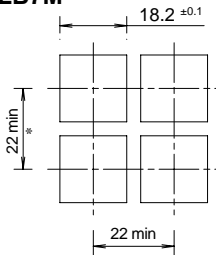

##### LB8/LB8M

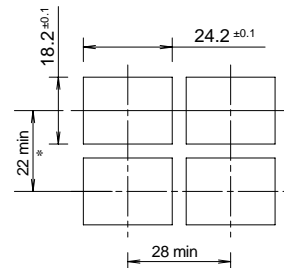
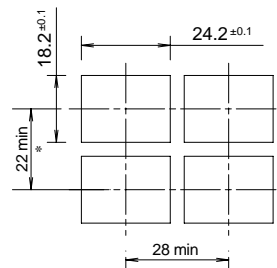

\* 45 mm minimum for switches with guard

##### LBW Series Flush Bezel LBW6/LBW6M

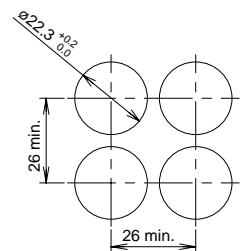

##### LBW Series Flush Bezel LBW7/LBW7M

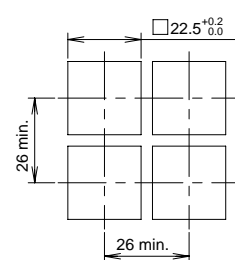

\* 53 mm minimum for switches with guard

#### Assembly Procedure

1. Install the operator to the panel.
2. Mount the contact block to the operator from the rear.
3. Turn the locking lever to lock the contact block.
4. Insert the PC board to terminals and solder.

Note 1: Make sure that each terminal is inserted into the PC board correctly.

Note 2: Do not apply tensile force to the connector cable for an extended period of time.

Note 3: Do not expose the contact block to water.

Note 4: Ensure to lock contact blocks when the contact blocks are installed on the operators.

• UP series can be installed on the same board. For details, see page 52.

Illuminated Pushbutton
Pilot Light
Pushbutton
Selector
Illuminated Selector
Key Selector
Lever Switch
Buzzer
Accessories
Maintenance Parts
Panel Cut-out
Instructions

# UP Series Single Board Mount Pilot Lights

## Mounts on the same panel as LB/LBW series



- Three illumination colors: Green (G), red (R), and white (W)

### Specifications

Color Code		Red (R), White (W)	G (Green)
Rated Current (I)		7mA	2mA
Maximum Current (Ta: 25°C)	Reverse Voltage (V <sub>R</sub> )	9V	5V
	Operating Temperature (T <sub>opr</sub> )	-20 to +55 (no freezing)	
	Storage Temperature (T <sub>stg</sub> )	-25 to +80 (no freezing)	
Forward Voltage (V <sub>f</sub> )		Standard value: 2V (If=7mA)	Standard value: 2.7V (If=2 mA)
Dielectric Voltage			
		Between live and dead parts: 500V AC, 1 minute	
Weight (approx.)		4.3g (UP8-89V1), 5.1g (UP8-89V2)	

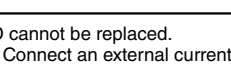

### UP Series

Mounting Hole Size	Shape	Degree of Protection (IEC 60529)	Mountable Unit	Part No.	Ordering No.	Illumination Color Code	Package Quantity
ø8 UP8  With standard bezel  With flush bezel	Shroud	IP40	Standard Bezel	<b>UP8-89V1*</b>	<b>UP8-89V1*PN10</b>	Specify the color code in place of * in the Part No.  G: green R: red W: white	10
			Flush Bezel	<b>UP8-89V2*</b>	<b>UP8-89V2*PN10</b>		
ø9 UP9P  With standard bezel  With flush bezel	Shroud	IP65	Standard bezel Flush bezel	<b>UP9P-99V1*</b>	<b>UP9P-99V1*PN10</b>		10

• LED cannot be replaced.

Note: Connect an external current limiting resistor in series. Otherwise, the LED may be damaged.

### Dimensions

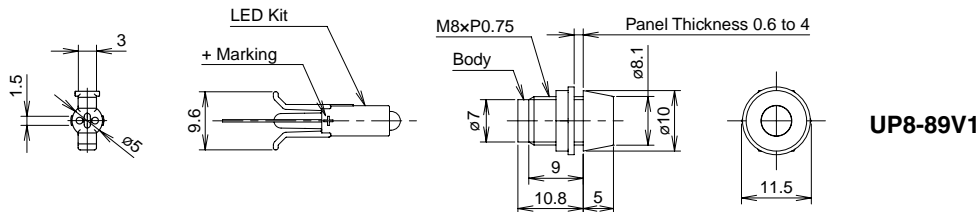

### [Assembly Drawing]

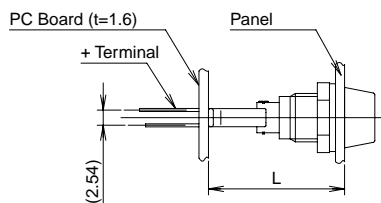

#### Dimensions (L)

Standard Bezel	22.5mm
Flush Bezel	29.9mm

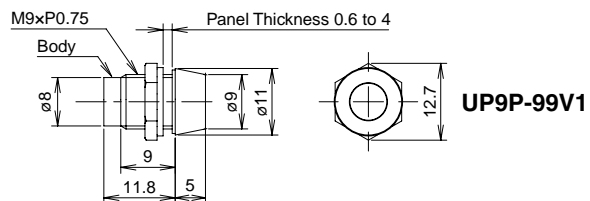
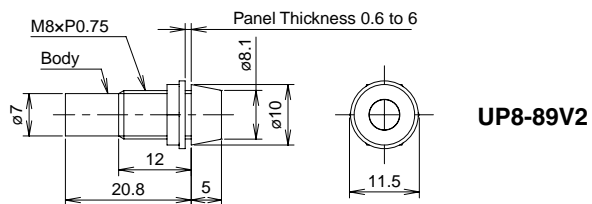

### PC Board Mounting Hole

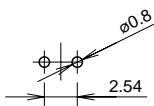

### Panel Cut-out

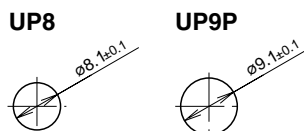

### Internal Circuit

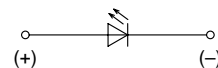

The longer pin is the positive terminal

All dimensions in mm.

# UP Series Single Board Mount Pilot Lights

## Safety Precautions

- Turn off power to the unit before installation, removal, wiring, maintenance, and inspection. Failure to turn off may cause electrical shocks or fire hazard.
- For wiring, use wires of a proper size to meet the voltage and current requirements.
- Improper soldering or failure to tighten the terminal screw may cause overheating and fire.

## Single Board Mounting

UP series miniature pilot light single board mounting types can be mounted with LB/ LBW series on the same panel. Follow the instructions below on single board mounting.

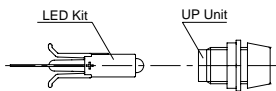

1. Mount the LED kit to the PC board.

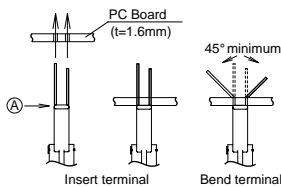

### Temporary mounting

1. Note the polarity of the terminals and insert the terminals to the PC board.
2. Make sure that part A of the LED kit is pressed tightly to the PC board. Bend the terminals sideways as shown on the left.

2. Mount the operator and the UP series pilot lights on to the control panel.

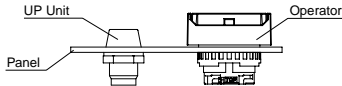

3. Mount the contact block to the operator of the miniature control unit and lock the unit by turning the locking lever.

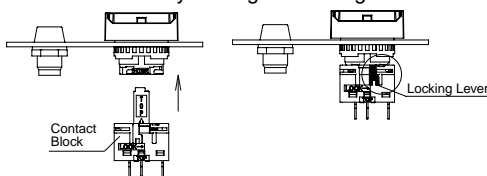

4. Install the PC board in 1. to the panel in 3.

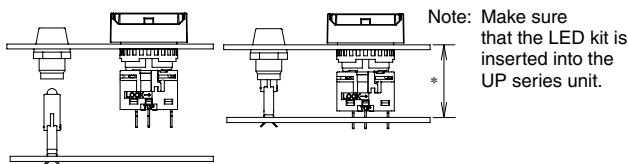

5. Solder the terminals.

Before soldering, make sure that each terminal of the contact block is securely inserted into the PC board holes.

- \* When mounting LB/LBW and UP series on a single board, make sure that the distance between the front of the panel and the mounting side of the PC board is as shown in the table below.

Part No.	Mountable Unit	Distance (*)
UP8-89V1*	Standard bezel	22.5mm
UP8-89V2*	Flush bezel	29.9mm
UP9P-99V1*	Standard bezel	22.5mm
	Flush bezel	29.9mm

## Instructions

### Polarity

Pay attention to the polarity of the power supply as UP series units do not contain a diode for protection against reverse polarity. The long terminal is positive and the short terminal is negative.

### Current Limiting Resistor

When using a UP series unit without a built-in current limiting resistor, connect an external current limiting resistor. Calculate the resistance using the following formula.

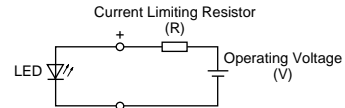

$$\text{Resistance } (\Omega) = \frac{\text{Operating Voltage (V)} - \text{Forward Voltage (Vf)}}{\text{Rated Current (I)} *}$$

- \* Rated Current (I) = R (red), W (white) : 0.007A  
G (green) : 0.002A
- Forward Voltage (Vf) = R (red), W (white): 2V  
G (green) : 2.7V

Note: Use a resistor of higher resistance than the calculated value ( $\Omega$ )

$$\text{Rated Wattage of Resistor (W)} = \frac{\text{Rated Current (I)} \times \text{Operating Voltage (V)} \times 2 \text{ to } 3 *}{* 2 \text{ to } 3 \text{ is a safety factor}}$$

### <Current Limiting Resistor Reference Value>

Operating Voltage	Color	Red (R), White (W)	Green (G)
	5V DC		430 $\Omega$ (1/4W)
6V DC		560 $\Omega$ (1/4W)	1600 $\Omega$ (1/4W)
12V DC		1500 $\Omega$ (1/4W)	4700 $\Omega$ (1/4W)
24V DC		3000 $\Omega$ (1/2W)	11000 $\Omega$ (1/4W)

### Countermeasures against Dim Lighting

See page 66.

### Wiring

Solder the terminal at 350°C within 3 seconds using a 60W soldering iron. SnAgCu type lead-free solder is recommended. When soldering, do not touch the pilot light housing with the terminal. Do not bend the terminal or apply excessive force to the terminal.

### Notes on Panel Mounting

Tightening torque should not exceed 0.49 N·m. Do not use pliers. Do not tighten with excessive force, otherwise the locking ring will be damaged.

### PC Board and Circuit Design

Use glass epoxy copper clad laminate, double-sided through-hole PC boards with a thickness of 1.6 mm.

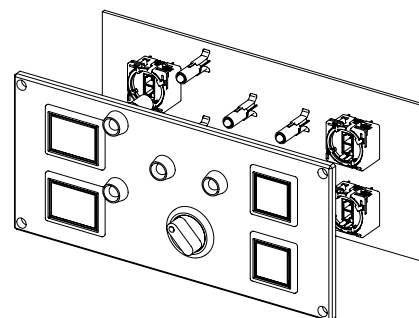

Example of single board mounting

Flush Silhouette  
LB Series

Flush Silhouette  
LBW Series

$\phi$ 16  
LB Series

UP Series

Illuminated  
Pushbutton

Pilot Light

Pushbutton

Selector

Illuminated  
Selector

Key Selector

Lever Switch

Buzzer

Accessories

Maintenance  
Parts







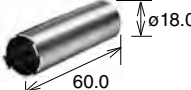

Panel  
Cut-out

Instructions

# LB/LBW Series Accessories















## Accessories

Package Quantity:1

Shape	Specification	Part No.	Ordering No.	Package Quantity	Remarks
Locking Ring Wrench 	Metal (Nickel-plated brass)	<b>MT-001</b>	<b>MT-001</b>	1	Used to tighten the locking ring when installing the units on to the panel.
Lens Removal Tool 	Stainless Steel	<b>MT-101</b>	<b>MT-101</b>	1	Used to remove the lens or button. (for standard bezels)
Switch Guard (180° Spring return) 	For round / square units (LB1/LB2)	<b>AL-K6SP</b>	<b>AL-K6SP</b>	1	Degree of protection: IP65 Used to protect pushbuttons and illuminated pushbuttons from inadvertent operation. See page 56 for dimensions. With the gasket mounted on the switch, attach the switch guard and mount on the panel.
	For rectangular units (LB3/LB4)	<b>AL-KH6SP</b>	<b>AL-KH6SP</b>	1	
Switchguard for Single Board Mounting 	For rectangular units (LB3/LB4)	<b>LA9Z-K3</b>	<b>LA9Z-K3</b>	1	Degree of protection: IP65 With the gasket mounted on the switch, attach the switch guard and mount on the panel. See page 56 for dimensions.
Rubber Boot ①  ②  ③ 	1. For round units (LB1)	<b>LB9Z-D1</b>	<b>LB9Z-D1</b>	1	Degree of protection: IP65 See page 56 for dimensions. See page 65 for mounting.
	2. For square units (LB2)	<b>LB9Z-D2</b>	<b>LB9Z-D2</b>	1	
	3. For rectangular units (LB3/LB4)	<b>LB9Z-D3</b>	<b>LB9Z-D3</b>	1	
Mounting Hole Plug 	Metal	<b>AL-BM6</b>	<b>AL-BM6</b>	1	Degree of protection: IP65 Tightening torque: 0.1 to 0.29 N·m See page 56 for dimensions.
Mounting Hole Plug 	Rubber	<b>AL-B6</b>	<b>AL-B6PN05</b>	5	Degree of protection: IP65 See page 56 for dimensions.

## Accessories

Package Quantity: 1

Shape		Specification	Part No.	Ordering No.	Package Quantity	Remarks
For LB Series Flush Bezels	Rubber Boot ① 	1. For round units (LB6/LB6M)	Rubber (Transparent silicon rubber)	<b>LB9Z-D6</b>	<b>LB9Z-D6</b>	Degree of protection: IP65 See page 57 for dimensions. See page 65 for mounting.
	② 	2. For square units (LB7/LB7M)		<b>LB9Z-D7</b>	<b>LB9Z-D7</b>	
	③ 	3. For rectangular units (LB8/LB8M)		<b>LB9Z-D8</b>	<b>LB9Z-D8</b>	
	Mounting Hole Plug ① 	1. For round units (LB6/LB6M)	[Plug] Polyamide (Black)	<b>LB9Z-BS6*</b>	<b>LB9Z-BS6*</b>	* Color code: blank (black), W (white) Degree of protection: IP65 Panel thickness: 0.5 to 3.2 mm See page 57 for dimensions.
		② 	[Gasket] Nitrile rubber	<b>LB9Z-BS7*</b>	<b>LB9Z-BS7*</b>	
		③ 	[Mounting Plate] Stainless Steel	<b>LB9Z-BS8*</b>	<b>LB9Z-BS8*</b>	
For LBW Series Flush Bezels	Mounting Hole Plug ① 	1. For round units (LBW6/LB6W6M)	[Plug] Polyamide (Black)	<b>LBW9Z-BS6*</b>	<b>LBW9Z-BS6*</b>	* Color code: blank (black), W (white) Degree of protection: IP65 Panel thickness: 0.5 to 3.2 mm See page 58 for dimensions.
		② 	2. For rectangular units (LBW7/LB6W7M)	[Gasket] Nitrile rubber [Mounting Plate] Stainless Steel	<b>LBW9Z-BS7*</b>	
	Mounting Hole Plug 	Metal	[Plug] Zinc diecast [Locking Ring] Polyamide [Gasket] Nitrile rubber	<b>LW9Z-BM</b>	<b>LW9Z-BM</b>	Degree of protection: IP66 Tightening torque: 1.2 N·m See page 58 for dimensions.
	Mounting Hole Plug 	Rubber	Nitrile rubber	<b>LW9Z-BP1</b>	<b>LW9Z-BP1</b>	Degree of protection: IP65 Tightening torque: 2.0 N·m See page 58 for dimensions.
	Terminal Cover ① 	1. For SPDT/DPDT contacts	PBT (White)	<b>LB9Z-VL2</b>	<b>LB9Z-VL2PN10</b>	10
② 		2. For 3PDT contacts		<b>LB9Z-VL3</b>	<b>LB9Z-VL3PN10</b>	
Key  Reversible key  Non-reversible key	For key selector switches (wave key)	Metal (zinc nickel-plated)	<b>LA9Z-SK-*</b>	<b>LA9Z-SK-*</b> PN02	2	Specify a key number in place of * in the Part No. Blank: Standard key 0H (reversible) 1H to 2H: Reversible key 3H to 6H: Non-reversible key See page 58 for dimensions.
	For key selector switches (disc tumbler key)	Metal (brass nickel-plated) 18×1.8×25.1 t1.8	<b>AS6-SK-132</b>	<b>AS6-SK-132PN02</b>	2	

Flush Silhouette LB Series

Flush Silhouette LBW Series

ø16 LB Series

UP Series

Illuminated Pushbutton

Pilot Light

Pushbutton

Selector

Illuminated Selector

Key Selector

Lever Switch

Buzzer

Accessories

Maintenance Parts

Panel Cut-out

Instructions

# LB/LBW Series Accessories

## Dimensions for Accessories

### For LB Series Standard Bezel

All dimensions in mm.

#### Rubber Boot

For round units  
(LB9Z-D1)

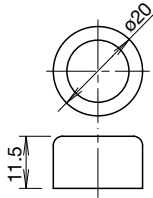

For square units  
(LB9Z-D2)

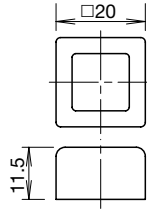

For rectangular units  
(LB9Z-D3)

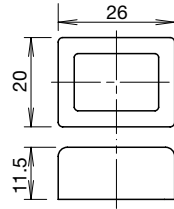

#### Mounting Hole Plug

AL-B6

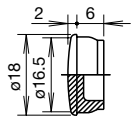

Mounting Hole  
Layout

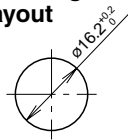

AL-BM6

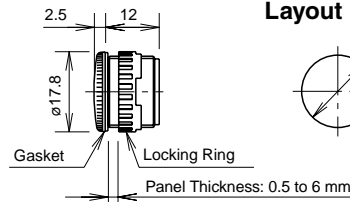

Mounting Hole  
Layout

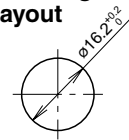

#### Switch Guard

For round / square units  
(AL-K6SP)

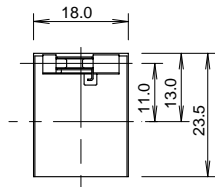

[For round / square units]

For rectangular units  
(AL-KH6SP)

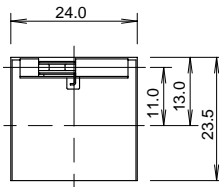

[For rectangular units]

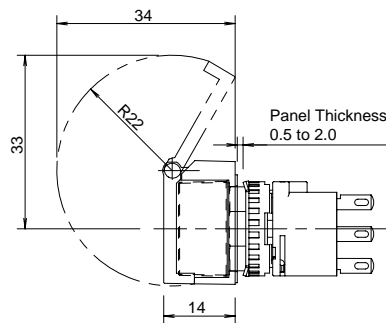

#### For Single Board Mounting (LA9Z-K3)

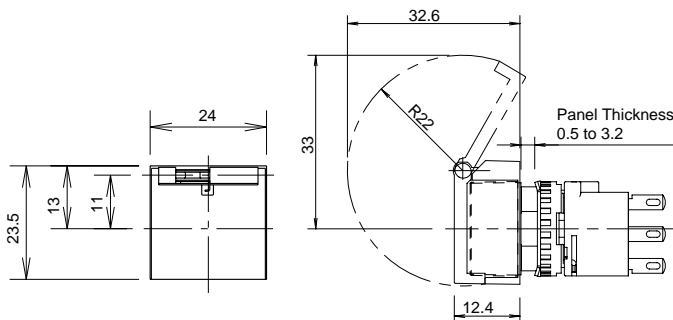

Note: The panel depth is the same for switches with or without switch guards. Both types can be installed on the same PC board.



## Dimensions for Accessories

Flush Silhouette

LB Series

Flush Silhouette

LBW Series

ø16

LB Series

UP Series

### For LB Series Flush Bezel

#### Rubber Boot

For round units  
(LB9Z-D6)

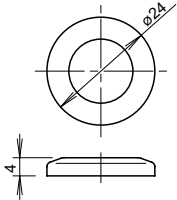

For square units  
(LB9Z-D7)

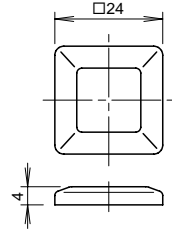

For rectangular units  
(LB9Z-D8)

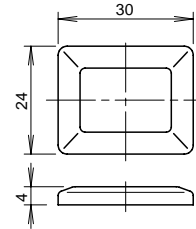

#### Mounting Hole Plug

For round units  
(LB9Z-BS6\*)

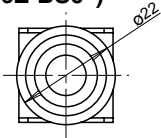

For square units  
(LB9Z-BS7\*)

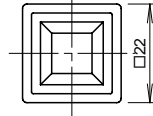

For rectangular units  
(LB9Z-BS8\*)

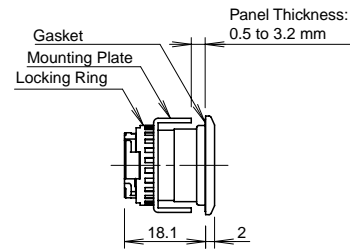
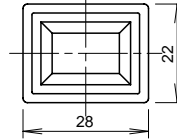

#### Mounting Hole Layout

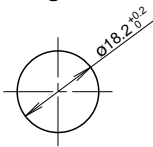

#### Mounting Hole Layout

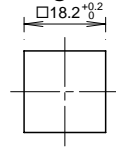

#### Mounting Hole Layout

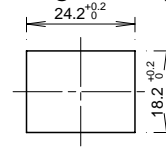

Illuminated  
Pushbutton

Pilot Light

Pushbutton

Selector

Illuminated  
Selector

Key Selector

Lever Switch

Buzzer

Accessories

Maintenance  
Parts

Panel  
Cut-out

Instructions

# LB/LBW Series Accessories

## Dimensions for Accessories

### For LB Series Flush Bezel

#### Mounting Hole Plug

**Metal  
(LW9Z-BM)**

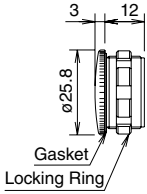

**Mounting  
Hole Layout**

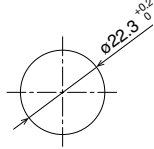

**Rubber  
(LW9Z-BP1)**

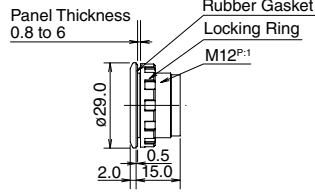

**Mounting  
Hole Layout**

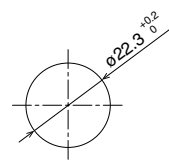

**For round units  
(LBW9Z-BS6\*)**

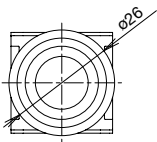

**Mounting  
Hole Layout**

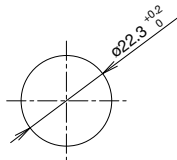

**For square units  
(LBW9Z-BS7\*)**

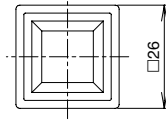

**Mounting  
Hole Layout**

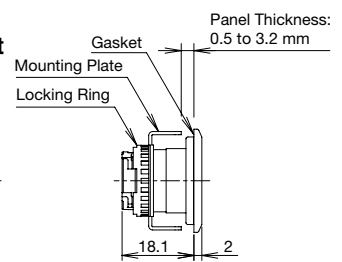
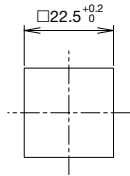

#### Terminal Cover

**For SPDT/DPDT contacts  
(LB9Z-VL2)**

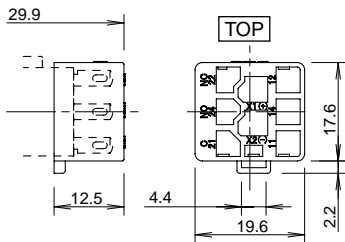

**For 3PDT contacts  
(LB9Z-VL3)**

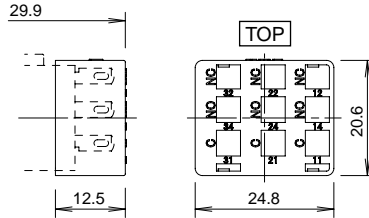

#### Key (Wave Key)

**Reversible key**

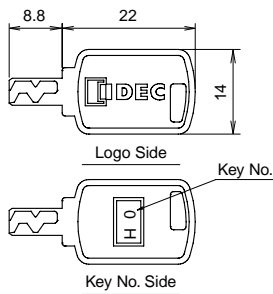

**Non-reversible key**

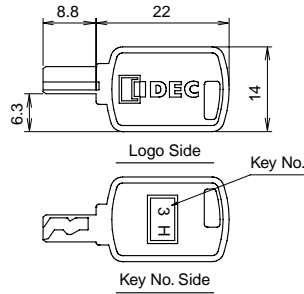

All dimensions in mm.

## Accessories

Shape		Material / Dimensions (W×H×D)	Part No.	Ordering No.	Package Quantity	Remarks	
<b>Lens</b> 	1. For round units	Polyarylate ø15.4 H4	<b>AL6M-L*</b>	<b>AL6M-L*PN05</b>	5	Specify the color code in place of * in the part no. A: Amber, C: Clear, G: Green, R: Red, S: Blue, Y: Yellow  Note: Use a clear lens for white (W) or pure white (PW) illumination.	
	2. For square units	Polyarylate □15.4 H4	<b>AL6Q-L*</b>	<b>AL6Q-L*PN05</b>	5		
	3. For rectangular units	Polyarylate W21.4 H4 D15.4	<b>AL6H-L*</b>	<b>AL6H-L*PN05</b>	5		
	4. For dome units	Polyarylate ø16 H9.4	<b>AL6D-L*</b>	<b>AL6D-L*PN05</b>	5		
<b>Buttons</b> 	1. For round units	Polyarylate ø15.4 H4	<b>AB6M-B*</b>	<b>AB6M-B*PN05</b>	5	Specify the color code in place of * in the part no. B: Black, G: Green, R: Red, S: Blue W: White, Y: Yellow	
	2. For square units	Polyarylate □15.4 H4	<b>AB6Q-B*</b>	<b>AB6Q-B*PN05</b>	5		
	3. For rectangular units	Polyarylate W21.4 H4 D15.4	<b>AB6H-B*</b>	<b>AB6H-B*PN05</b>	5		
<b>Marking plate</b> 	1. For round units	Acrylic ø13.7 H0.8	<b>AL6M-*</b>	<b>AL6M-*PN05</b>	5	Specify the color code in place of * in the part no. B: Black, W: White  See page 63 for dimensions and engraving area.	
	2. For square units	Acrylic □13.7 H0.8	<b>AL6Q-*</b>	<b>AL6Q-*PN05</b>	5		
	3. For rectangular units	Acrylic W19.7 H0.8 (0.4) D13.7	<b>AL6H-*</b>	<b>AL6H-*PN05</b>	5		
<b>Diffusion plate</b> 	For dome units	Acrylic ø13.6 H2.8	<b>AL6D-W</b>	<b>AL6D-WPN05</b>	5	White	
<b>Anti-rotation Ring</b> 	Standard bezel	Metal (Stainless steel) □17.9 t0.6	<b>LB9Z-LP1</b>	<b>LB9Z-LP1PN10</b>	10		
<b>Anti-rotation Ring</b> 	Flush bezel	Metal (Stainless steel) 21×8.2×20.6 t0.8	<b>LB9Z-LP6</b>	<b>LB9Z-LP6PN10</b>	10		
<b>LBW Series</b>	<b>Lens</b> 	1. For round flush units	Polyarylate ø20 H4	<b>HA9Z-L11*</b>	<b>HA9Z-L11*PN05</b>	5	Specify the color code in place of * in the part no. A: Amber, C: Clear, G: Green, R: Red, S: Blue, Y: Yellow Note: Use a clear lens for white (W) or pure white (PW) illumination.
		2. For square flush units	Polyarylate ø20 H4	<b>HA9Z-L21*</b>	<b>HA9Z-L21*PN05</b>	5	
	<b>Buttons</b> 	1. For round flush units	Polyacetal ø20 H3.2 (L5)	<b>HA9Z-B11*</b>	<b>HA9Z-B11*PN05</b>	5	Specify the color code in place of * in the part no. B: Black, G: Green, R: Red, S: Blue W: White, Y: Yellow
		2. For square flush units	Polyacetal ø20 H3.9 (L5)	<b>HA9Z-B21*</b>	<b>HA9Z-B21*PN05</b>	5	
		3. For round extended units	Polyacetal ø19.8 H7.3 (L9.1)	<b>HA9Z-B12*</b>	<b>HA9Z-B12*PN05</b>	5	
		4. For square extended units	Polyacetal ø19.8 H8 (L9.1)	<b>HA9Z-B22*</b>	<b>HA9Z-B22*PN05</b>	5	
	<b>Marking plate</b> 	1. For round flush units	Acrylic ø17 t0.85 (L1.1)	<b>HA9Z-P1*</b>	<b>HA9Z-P1*PN05</b>	5	Specify the color code in place of * in the part no. B: Black, W: White See page 64 for dimensions and engraving area.
		2. For square units	Acrylic □18.4 t0.85	<b>HA9Z-P2*</b>	<b>HA9Z-P2*PN05</b>	5	
	<b>Anti-rotation Ring</b> 	LBW series	Metal (Stainless steel) 25×8.2×24.8 t0.8	<b>LBW9Z-LP6</b>	<b>LBW9Z-LP6PN10</b>	10	
	<b>Locking ring</b> 	All models	Polyamide ø17.9 H3.9	<b>LB9Z-LN</b>	<b>LB9Z-LNPN10</b>	10	
<b>Illuminated selector knob operator</b> 	Illuminated selector switches	<For operator> Polyarylate Waterproof O-gasket Nitril rubber ø15.4 H13	<b>LA1A-F*</b>	<b>LA1A-F*PN02</b>		Specify the color code in place of * in the part no. G: green, R: red, W: white	

Flush Silhouette  
LB Series

Flush Silhouette  
LBW Series

ø16  
LB Series

UP Series

Illuminated  
Pushbutton

Pilot Light

Pushbutton

Selector

Illuminated  
Selector

Key Selector

Lever Switch

Buzzer

Accessories

Maintenance  
Parts

Panel  
Cut-out

Instructions

# LB/LBW Series Maintenance Parts

## Maintenance Parts

### LB Series Maintenance LED Unit

Package Quantity: 1

Shape	Rated Operating Voltage	Part No. (Ordering No.)	* Color Code
	5V DC	<b>LB9Z-LED5*</b>	A: Amber G: Green PW: Pure White R: Red S: Blue W: White
	12V AC/DC	<b>LB9Z-LED1*</b>	
	24V AC/DC	<b>LB9Z-LED2*</b>	

- All LB/LBW series contain an LED unit.
- Use a pure white (PW) LED unit for yellow (Y) illumination.

### Transformer

Package Quantity: 1

Transformer	Primary Voltage	Secondary Voltage	Part No. (Ordering No.)	Applicable Load
	AC100/110V	100/110V AC ±10%	<b>TWR512</b>	LB9Z-LED2* (24V AC/DC LED unit)
	AC200/220V	200/220V AC ±10%	<b>TWR522</b>	
	AC400/440V	400/440V AC±10%	<b>TWR542</b>	

- Terminal cover (TWR-VL3) is supplied as standard.
- Connect one LB9Z-LED2\* to a transformer.

### Specifications

Part No.	TWR5□2
Operating Voltage	100/110V AC, 200/220V AC, 400/440V AC (50/60Hz)
Current Draw	2.4VA
Rated Insulation Voltage	600V
Insulation Resistance	100 MΩ minimum (500V DC megger)
Operating Temperature	-30 to +60°C (no freezing)
Storage Temperature	-40 to +80°C (no freezing)
Operating Humidity	35 to 85% RH (no condensation)
Vibration Resistance	Damage Limits: 30 Hz, amplitude 1.5 mm Operating extremes: 5 to 55 Hz, amplitude 0.5 mm
Shock Resistance	Damage limits: 1,000 m/s <sup>2</sup> Operating Extremes: 100 m/s <sup>2</sup>
Dielectric Strength	2,500V AC, 1 minute
Terminal Screw	M3.5
Applicable Wire	2 mm <sup>2</sup> maximum, 2 wires maximum
Weight (approx.)	87g

### Dimensions

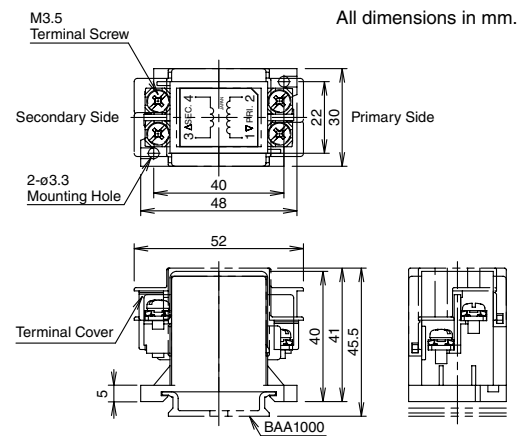

### Accessories

#### 35mm DIN Rail

Part No.	Ordering No.	Length	Material	Package Quantity
<b>BAA1000</b>	<b>BAA1000PN10</b>	1,000mm	Aluminum (approx. 200g)	10
<b>BAP1000</b>	<b>BAP1000PN10</b>	1,000mm	Steel (approx. 320g)	10

#### End Clip

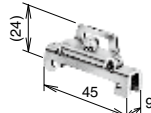
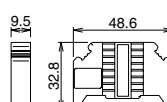
Part No.	Ordering No.	Applicable DIN Rail	Package Quantity	Dimensions
<b>BNL6</b>	<b>BNL6PN10</b>	BAA1000 BAP1000	10	 <p>Approx. 15g Steel (Zinc-plated)</p>
<b>BC9Z-E/NS35N</b>	<b>BC9Z-E/NS35NPN10</b>	BAA1000 BAP1000	10	 <p>Approx. 15g</p>

- Use plastic end clip BC9Z-E/NS35N when using 400/440V AC primary voltage transformers.

# Flush Silhouette Switch LB Series Flush Silhouette Switch LBW Series ø16mm LB Series Miniature Switches and Pilot Lights

## Contents

⚠ <b>Safety Precautions</b> . . . . .	61		
<b>Instructions</b> . . . . .	61		
Wiring . . . . .	61	Terminal Cover . . . . .	61
Operating Environment . . . . .	61	Handling . . . . .	61
Removing and Installing the Contact Block . . . . .	62	Panel Mounting . . . . .	62
Replacing the Lens and Marking Plate . . . . .	62	Installing the Lens Unit and Contact Block . . . . .	63
Marking Plates and Films . . . . .	63	Replacing the LED Unit . . . . .	64
Notes on Using Quick Connect Terminals . . . . .	64	Installing the Rubber Boot . . . . .	65
Maintained Pushbuttons . . . . .	65	Switches with Guard . . . . .	65
Selector Switches . . . . .	65	Key Selector Switches . . . . .	66
<b>Single Board Mounting</b> . . . . .	51		
Installing and Removing Contact Blocks . . . . .	51	Mounting Holes and Assembly Procedure . . . . .	51

## ⚠ Safety Precautions

- Turn off the power to the LB/LBW series before installation, removal, wiring, maintenance, and inspection. Failure to turn power off may cause electrical shocks or fire hazard.
- To avoid burning your hand, use the lamp holder tool when replacing the lamps.
- For wiring, use wires of a proper size to meet voltage and current requirements. Solder correctly according to the instructions in "Wiring" and "Notes on Terminal Cover." Improper soldering may cause overheating and create a fire hazard. Also, when using tab terminals, use receptacles of appropriate size.

## Instructions

### Wiring

- 1) Solder the terminals at 350°C within 3 seconds using a 60W soldering iron. Sn-Ag-Cu type is recommended when using leadfree solder. When soldering, do not touch the LB series with the soldering iron. Also ensure that no tensile force is applied to the terminal. Do not bend the terminal or apply excessive force to the terminal.
- 2) Use non-corrosive liquid flux.

### Terminal Cover

#### Solder/tab terminal

Insert the terminal cover into the contact block with the TOP markings on the contact block and the terminal cover in the same direction.

Note: When wiring, insert the lead wires into the terminal cover holes before soldering.  
After wiring, the terminal covers cannot be installed.

#### Standard Bezel



#### Flush Bezel



### Operating Environment

- Do not use the LB/LBW series where corrosive gases exist or under an environment exceeding the operating temperature and humidity ranges. Otherwise, damages due to contact failure or change of surface color may occur.
- Major parts of the switch are plastic. Scratches or damages may occur when scraped with a sharp object or applied with excessive load or shock. Note that this may cause operation and appearance failure of the operator and bezel.
- Adherence of detergent, cutting oil, or special chemicals to the switch may result in operation failures and appearance failures such as change of surface color.

### Handling

#### Contacts (micro switch)

When using NC (normally closed) and NO (normally open) contacts of the same microswitch, avoid connections of different voltages, or connections of different types of power supplies. Failure to observe this instruction may cause a short-circuit.

#### Protection against oil (IP65)

The LB series has been tested according to JIS C 0920: Appendix 1 by using water insoluble cutting oil Class N3, No. 8 (JIS K 2241) to prove that the switches will not be damaged by oil drops or splashes. This may not apply to special types of oils. Contact IDEC for details.

Flush Silhouette LB Series
Flush Silhouette LBW Series
ø16 LB Series
UP Series

Illuminated Pushbutton
Pilot Light
Pushbutton
Selector
Illuminated Selector
Key Selector
Lever Switch
Buzzer
Accessories
Maintenance Parts
Panel Cut-out
Instructions

## Instructions

### Removing and Installing the Contact Block

- 1) Turn the locking lever on the contact block in the direction opposite to the arrow on the housing. Then the contact block can be removed.
- 2) Insert the contact block with the TOP markings on the contact block and the operator placed in the same direction. Then lock the units, turning the locking lever in the direction of the arrow.

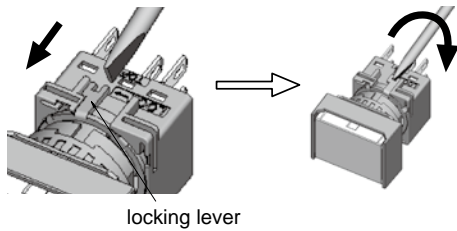

### Panel Mounting

Remove the contact block from the operator. Insert the operator into the panel cut-out from the front, then install the contact block to the operator.

(For Standard Bezel)

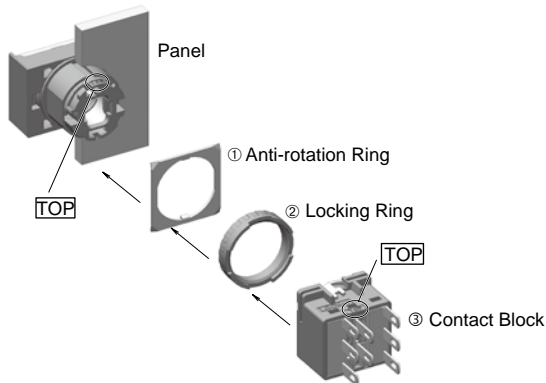

(For Flush Bezel)

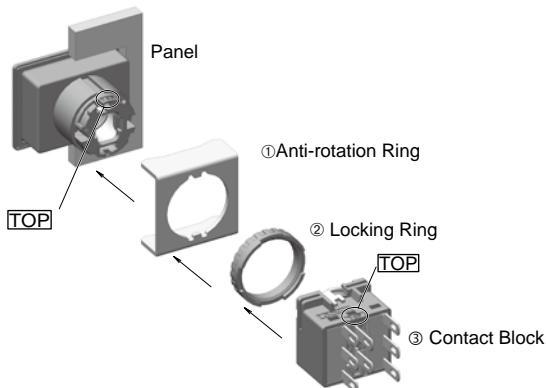

### Notes on Mounting

Use the optional ring wrench (MT-001) to mount the operator onto the panel. The recommended tightening torque is 0.5 to 0.7 N·m. Do not use pliers. Excessive tightening will damage the locking ring.

### Replacing the Lens and Marking Plate

#### Removing

[Removing the operator]

##### Standard Bezel

- 1) From the opposite side of the TOP marking, remove the operator (lens, marking plate, and lens holder) using the optional lens removal tool (MT-101) by gripping the recesses of the color lens.

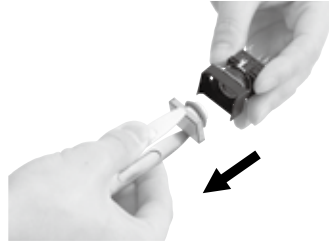

##### Flush Bezel

- 1) From the opposite side of the TOP marking, push the tip (width: 3 mm, thickness: 0.5 mm) of the flat screwdriver to the groove of the color lens and pull out the operator (lens, marking plate, lens holder).

Note: For metallic bezels, the bezel may be damaged if the screwdriver is inserted from the TOP side or inserted deeply or with force into the groove of the lens.

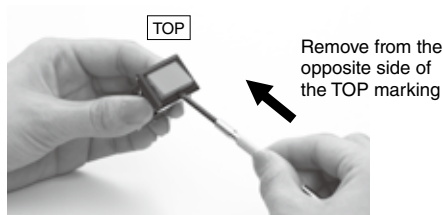

[Removing the Operator]

- 2) Remove the marking plate by pushing the lens from the rear to disengage the latches between the lens and holder, using the screwdriver as shown below.

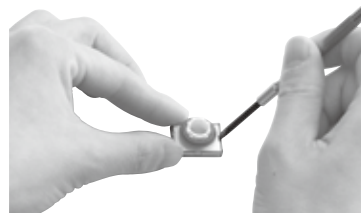

Note: The translucent in the lens holder cannot be removed because this filter is sealed to make the unit waterproof and oiltight.

### LBW Series Pushbutton (button style)

LBW series pushbuttons (button style, see page 28) can be removed according to the following procedure. LBW series pushbuttons (button style) cannot be removed from the front of the panel.

[Removing the Operator]

- 1) Detach the operator unit and contact block. (See Removing and Installing the Contact Block at the top of the page.)
- 2) Remove the button unit (button, button holder) by pushing out the cross-shaped protrusion (white) at the back of the operator with a screwdriver.

## Instructions

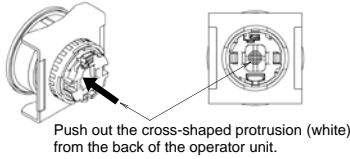

### Removing the Button

The button can be removed by inserting a small screwdriver into the groove of the button holder.

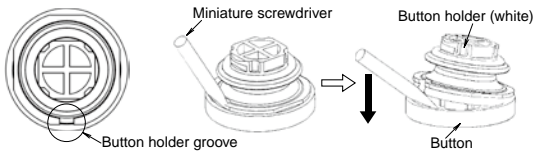

To attach the button to the button holder, align the groove on cross-shaped protrusion with the positioning protrusion on the button and insert securely.

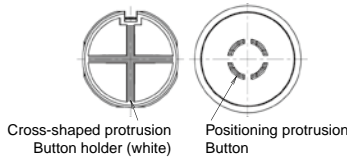

### Installing

Insert the marking plate into the color lens, and press the lens onto the lens holder to engage the latches. Pay attention to the orientation of the marking plate.

#### LB/LBW Series Round

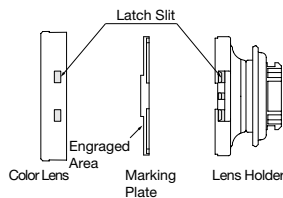

#### LB Series Square/Rectangular

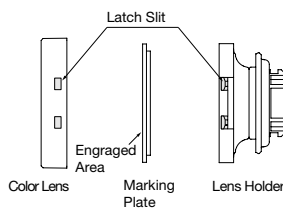

#### LBW Series Square

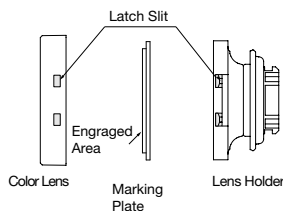

### Installing the Lens Unit and Contact Block

To insert the lens unit into the operator, press in the lens unit by making sure that the latch on the operator is aligned with the latch on the lens unit.

#### Round Lens Unit Square Lens Unit

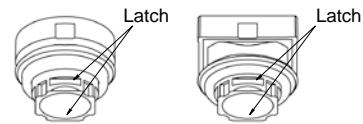

#### Standard Bezel

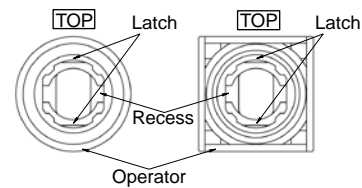

#### Flush Bezel

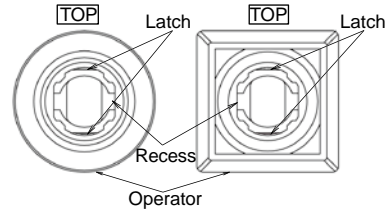

### Marking Plates and Films

For illuminated pushbuttons and pushbuttons with lens, legends and symbols can be engraved on the marking plates, or printed film can be inserted under the lens for labelling purposes.

#### Marking Plate and Marking Film Size

##### LB Series (flush bezel / standard bezel)

Lens	Round	Square	Rectangular
Built-in Marking Plate			
Applicable Marking Film			
	<ul style="list-style-type: none"> <li>Engraving must be made on the engraving area within 0.5 mm deep.</li> <li>The marking plate is made of white acrylic resin.</li> <li>Film thickness: 0.1 mm per film</li> <li>Marking film is not included.</li> <li>Recommended marking film: Polyester film</li> </ul>		

# LB/LBW Series Instructions

## Instructions

### LBW Series

Lens	Round Flush	Square	Round Extended
Built-in Marking Plate			
	<ul style="list-style-type: none"> <li>Engraving thickness: 0.5 mm max.</li> <li>The marking plate is made of white acrylic resin.</li> </ul>		
Applicable Marking Film			
	<ul style="list-style-type: none"> <li>Film thickness: 0.1 mm per 2 films or 0.2 mm per film.</li> <li>Marking film is not included.</li> <li>Recommended marking film: Polyester film</li> </ul>		

### LBW Series (ring-illuminated model)

Lens	Round (Note)	Square
Applicable Marking Film		
	<ul style="list-style-type: none"> <li>Film thickness: 0.1 mm max.</li> </ul>	

Note: Use a film with adhesive and attach on the light shield sheet. Make sure that the marking film is properly installed and does not protrude from the edge of light shield sheet.

### Ring Illuminated Model Lens Holder

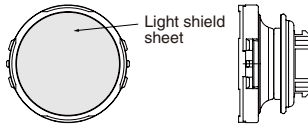

### Insertion Order of Marking Plate and Film

#### LB/LBW Series Round

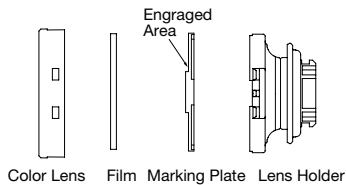

#### LB/LBW Series Square/Rectangular

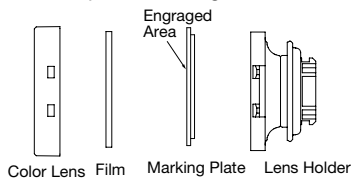

Note: Film is not included.

The marking plate must be engraved on the specified side as shown above. Pay attention to the orientation of the marking plate. When inserting a film, make sure to insert between the color lens and marking plate.

Note: Marking plate is not supplied with ring-illuminated model.

### Replacing the LED Unit

The LED unit can be replaced without tools by pulling out the lens unit from the contact block.

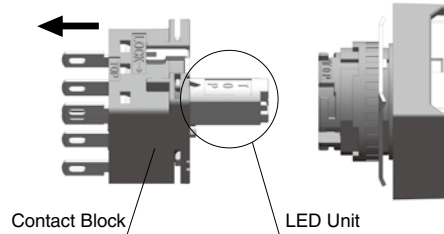

#### Orientation of the LED unit

Insert the LED unit into the contact block with the TOP markings on the contact block and LED unit in the same orientation.

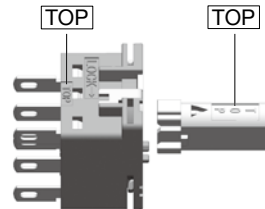

#### Notes on replacing the LED Unit

When replacing the LED unit, make sure that static electricity is not applied.

Make sure that the LB/LBW series has cooled down before replacing the LED unit. To avoid burn injuries, be careful not to touch the unit while it is still hot.

### Notes on Using Quick Connect Terminals

- Use #110 tab quick connects, 0.5 mm-thick.
- When connecting the terminals on the left and center, make sure that surfaces of the quick connects face each other. Otherwise, short-circuit may occur.

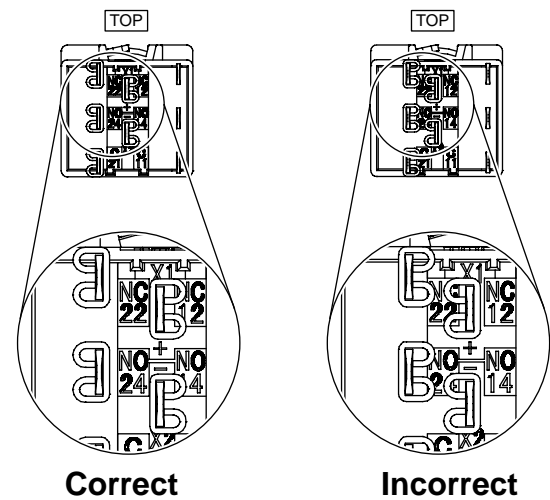

- Apply only horizontal force against the panel to the tab. The switch may be damaged if a force other than a horizontal force is applied.



## Instructions

### Installing the Rubber Boot

When using in places where the switches are subjected to water splash or an excessive amount of dust, make sure to use the optional rubber boot.

As shown in the drawing below, ① remove the gasket from the operator, and ② attach the rubber boot from the front (button side).

#### Standard Bezel

For rectangular and square units, pull out the seals of the rubber boot and place them around the operator sleeve as shown below. Make sure that the seals are not twisted or tucked inside and that the gasket is removed, otherwise waterproof and dustproof characteristics are not ensured.

### How to Install the Rubber Boot

#### Rectangular

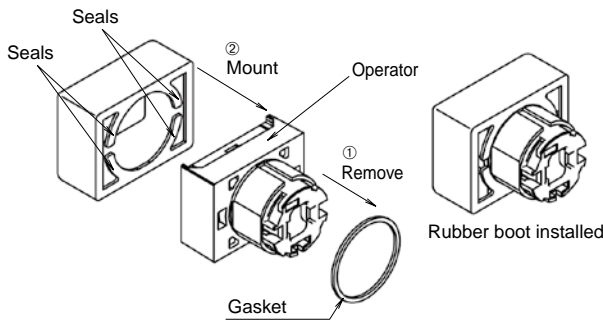

#### Square

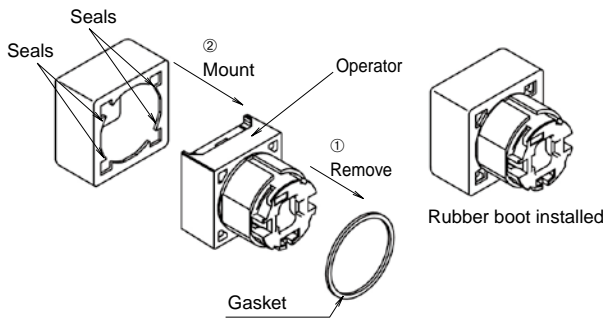

#### Round

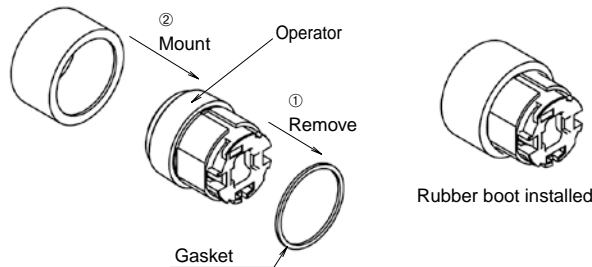

### Flush Bezel

Mount the rubber boot so that the protrusion at the bottom surface of the operator fits with the recess on the operator, placing the rubber boot all around the operator sleeve.

Make sure that the protrusion on the rubber boot and the recess on the operator is properly fitted, otherwise, the waterproof and dustproof characteristics are not ensured.

#### How to Install the Rubber Boot

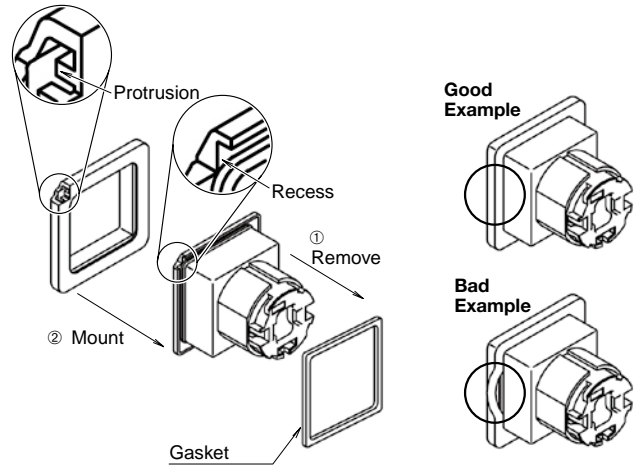

Note: Install the rubber boot before mounting the unit to the panel.

### Maintained Pushbuttons

Do not replace the buttons when the pushbutton is in the maintained position. Replacing the button in the maintained position may damage the internal mechanism. Also, do not remove the contact block with the button in the maintained position. The contact may not operate properly when the contact block is remounted. Make sure to push down fully when using the pushbuttons.

### Pushbuttons and Illuminated Pushbuttons with Switch Guard

Do not apply force to the switch guard when the switch guard is not attached to a panel. When opening the switch guard, do not open more than 180°. The hinge may break.

### Selector Switches

When turning the operator or key, make sure that they are properly turned to each position.

- Illuminated Pushbutton
- Pilot Light
- Pushbutton
- Selector
- Illuminated Selector
- Key Selector
- Lever Switch
- Buzzer
- Accessories
- Maintenance Parts
- Panel Cut-out
- Instructions

# LB/LBW Series Instructions

## Selector Switches with Key

Observe the following instructions to prevent malfunction or damage.

- Insert the key to the bottom of the key hole.
- Do not remove the key from any key retained position.
- Besides the standard key (key number 0H), six other key numbers are available. Use a key of the matching number with the key cylinder. The standard key does not have a key number indication.
- Keys are available in two types.  
Key numbers 0H (standard), 1H, and 2H are reversible keys which can be inserted in two ways.  
Key numbers 3H, 4H, 5H, and 6H are non-reversible keys. Make sure of correct insertion direction.

## Countermeasures against Dim Lighting

Leakage currents through transistors or a contact protection circuit may cause the LED lamp to illuminate dimly even when the output is off.

When the LED lamp is illuminated by a transistor output, take the following measure.

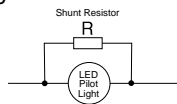

## Leakage Current Shunt Resistor Allotment Table (Recommended)

Leakage Current $I_o$	Shunt resistance R			
	Red (R), White (W)		Green (G)	
	Resistance	Rated Power	Resistance	Rated Power
0.1 mA max.	13k $\Omega$	0.25W	18k $\Omega$	0.25W
0.1 to 0.7 mA	2k $\Omega$	0.25W	2.7k $\Omega$	0.25W

## Noise

LED elements deteriorate due to extraneous noise, resulting in significant decrease in luminance, hue change, or failure of lighting. When such effects are anticipated, take a protection measure shown below. However, measures may differ according to operating environment and condition

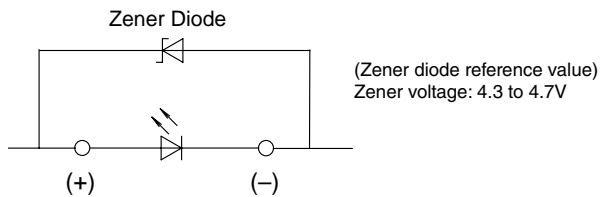

## Static Electricity (UP Series)

UP series are delicate products that may be damaged by static electricity. Make sure to take measures to prevent static electricity.



Specifications and other descriptions in this brochure are subject to change without notice.



## IDEC CORPORATION

6-64, Nishi-Miyahara 2-Chome, Yodogawa-ku, Osaka 532-0004, Japan  
Tel: +81-6-6398-2527, Fax: +81-6-6398-2547  
E-mail: marketing@idec.co.jp

**IDEC CORPORATION (USA)**  
1175 Elko Drive, Sunnyvale, CA 94089-2209, USA  
Tel: +1-408-747-0550 / (800) 262-IDECE (4332)  
Fax: +1-408-744-9055 / (800) 635-6246  
E-mail: opencontact@idec.com

**IDEC CANADA LIMITED**  
3155 Pepper Mill Court, Unit 4  
Mississauga, Ontario, L5L 4X7, Canada  
Tel: +1-905-890-8561, Toll Free: (800) 262-IDECE (4332)  
Fax: +1-905-890-8562  
E-mail: sales@ca.idec.com

**IDEC AUSTRALIA PTY. LTD.**  
Unit 17, 104 Ferntree Gully Road,  
Oakleigh, Victoria 3166, Australia  
Tel: +61-3-8523-5900, Toll Free: 1800-68-4332  
Fax: +61-3-8523-5999  
E-mail: sales@au.idec.com

**IDEC ELECTRONICS LIMITED**  
Unit 2, Beechwood, Chineham Business Park,  
Basingstoke, Hampshire RG24 8WA, UK  
Tel: +44-1256-321000, Fax: +44-1256-327755  
E-mail: sales@uk.idec.com

**IDEC ELEKTROTECHNIK GmbH**  
Wendenstrasse 331, 20537 Hamburg, Germany  
Tel: +49-40-25 30 54 - 0, Fax: +49-40-25 30 54 - 24  
E-mail: service@idec.de

**IDEC (SHANGHAI) CORPORATION**  
Room 701-702 Chong Hing Finance Center,  
No. 288 Nanjing Road West, Shanghai 200003, PRC  
Tel: +86-21-6135-1515  
Fax: +86-21-6135-6225 / +86-21-6135-6226  
E-mail: idec@cn.idec.com

**IDEC (BEIJING) CORPORATION**  
Room 211B, Tower B, The Grand Pacific Building,  
8A Guanghua Road, Chaoyang District,  
Beijing 100026, PRC  
Tel: +86-10-6581-6131, Fax: +86-10-6581-5119

**IDEC (SHENZHEN) CORPORATION**  
Unit AB-3B2, Tian Xiang Building, Tian'an Cyber Park,  
Fu Tian District, Shenzhen, Guang Dong 518040, PRC  
Tel: +86-755-8356-2977, Fax: +86-755-8356-2944

**IDEC IZUMI (H.K.) CO., LTD.**  
Unit G & H, 26/F., MG Tower,  
No. 133 Hoi Bun Road, Kwun Tong, Kowloon,  
Hong Kong  
Tel: +852-2803-8989, Fax: +852-2565-0171  
E-mail: info@hk.idec.com

**IDEC TAIWAN CORPORATION**  
8F-1, No. 79, Hsin Tai Wu Road, Sec. 1,  
Hsi-Chih District, 22101 New Taipei City, Taiwan  
Tel: +886-2-2698-3929, Fax: +886-2-2698-3931  
E-mail: service@tw.idec.com

**IDEC IZUMI ASIA PTE. LTD.**  
No. 31, Tannery Lane #05-01,  
HB Centre 2, Singapore 347788  
Tel: +65-6746-1155, Fax: +65-6844-5995  
E-mail: info@sg.idec.com

**IDEC ASIA (THAILAND) CO.,LTD.**  
20th Fl., Sorachai Bldg., No.23/78,  
Soi Sukhumvit 63, Sukhumvit Rd.,  
Klongton-nua, Wattana, Bangkok 10110  
Tel: +662-392-9765, Fax: +662-392-9768  
E-mail: sales@th.idec.com

www.idec.com