

Versatile and Function-filled Miniature Power Relay for Sequence Control and Power Switching Applications

- Many variations possible through a selection of operation indicators (mechanical and LED indicators), test button, built-in diode and CR (surge suppression), bifurcated contacts, etc.
- Arc barrier standard on 4-pole Relays.
- Dielectric withstand voltage: 2,000 VAC (coil to contact)
- Environment-friendly cadmium-free contacts.
- Safety standard approvals obtained.
- Wide range of Sockets (PY, PYF Series) and optional parts are available.
- Max. Switching Current: 2-pole: 10 A, 4-pole: 5 A
- Built-in mechanical operation indicator.
- Provided with nameplate.



Ordering Information

■ Relays

Standard Coil Polarity

Type	Contact form	Plug-in socket/Solder terminals		Without LED indicator
		Standard with LED indicator	With LED indicator and test button	
Standard	DPDT	MY2N	MY2IN	MY2
	4PDT	MY4N	MY4IN	MY4
	4PDT (bifurcated)	MY4ZN	MY4ZIN	MY4Z
With built-in diode (DC only)	DPDT	MY2N-D2	MY2IN-D2	---
	4PDT	MY4N-D2	MY4IN-D2	---
	4PDT (bifurcated)	MY4ZN-D2	MY4ZIN-D2	---
With built-in CR (220/240 VAC, 110/120 VAC only)	DPDT	MY2N-CR	MY2IN-CR	---
	4PDT	MY4N-CR	MY4IN-CR	---
	4PDT (bifurcated)	MY4ZN-CR	MY4ZIN-CR	---

Reverse Coil Polarity

Type	Contact form	Plug-in socket/Solder terminals	
		With LED indicator	With LED indicator and test button
Standard (DC only)	DPDT	MY2N1	MY2IN1
	4PDT	MY4N1	MY4IN1
	4PDT (bifurcated)	MY4ZN1	MY4ZIN1
With built-in diode (DC only)	DPDT	MY2N1-D2	MY2IN1-D2
	4PDT	MY4N1-D2	MY4IN1-D2
	4PDT (bifurcated)	MY4ZN1-D2	MY4ZIN1-D2

Note: When ordering, add the rated coil voltage to the model number. Rated coil voltages are given in the coil ratings table.

Example: MY2 6VAC

↑
Rated coil voltage

■ Accessories (Order Separately)

Sockets

Poles	Front-mounting Socket (DIN-track/screw mounting)	Back-mounting Socket				
		Solder terminals		Wire-wrap terminals		PCB terminals
		Without clip	With clip	Without clip	With clip	
2	PYF08A-E PYF08A-N	PY08	PY08-Y1	PY08QN PY08QN2	PY08QN-Y1 PY08QN2-Y1	PY08-02
4	PYF14A-E PYF14A-N	PY14	PY14-Y1	PY14QN PY14QN2	PY14QN-Y1 PY14QN2-Y1	PY14-02

Socket Hold-down Clip Pairing

Relay type	Poles	Front-connecting Socket (DIN-track/screw mounting)		Back-connecting Socket			
		Socket	Clip	Solder/Wire-wrap terminals		PCB terminals	
				Socket	Clip	Socket	Clip
Without 2-pole test button	2	PYF08A-E PYF08A-N	PYC-A1	PY08(QN)	PYC-P PYC-P2	PY08-02	PYC-P PYC-P2
	4	PYF14A-E PYF14A-N		PY14(QN)		PY14-02	
2-pole test button	2	PYF08A-E PYF08A-N	PYC-E1	PY08(QN)	PYC-P2	PY08-02	PYC-P2

Mounting Plates for Sockets

Socket model	For 1 Socket	For 18 Sockets	For 36 Sockets
PY08, PY08QN(2), PY14, PY14QN(2)	PYP-1	PYP-18	PYP-36

Note: PYP-18 and PYP-36 can be cut into any desired length in accordance with the number of Sockets.

Rail and Accessories

Supporting Rail (length = 500 mm)	PFP-50N
Supporting Rail (length = 1,000 mm)	PFP-100N, PFP-100N2
End Plate	PFP-M
Spacer	PFP-S

Specifications

■ Coil Ratings

	Rated voltage	Rated current		Coil resistance	Inductance (reference value)		Must operate	Must release	Max. voltage	Power consumption (approx.)
		50 Hz	60 Hz		Arm. OFF	Arm. ON				
AC	6 V*	214.1 mA	183 mA	12.2 Ω	0.04 H	0.08 H	80% max.	30% min.	110%	1.0 to 1.2 VA (60 Hz)
	12 V	106.5 mA	91 mA	46 Ω	0.17 H	0.33 H				
	24 V	53.8 mA	46 mA	180 Ω	0.69 H	1.30 H				
	48 V*	25.7 mA	22 mA	788 Ω	3.22 H	5.66 H				
	110/120 V	9.9/10.8 mA	8.4/9.2 mA	4,430 Ω	19.20 H	32.1 H				
	220/240 V	4.8/5.3 mA	4.2/4.6 mA	18,790 Ω	83.50 H	136.4 H				
DC	6 V*	151 mA		39.8 Ω	0.17 H	0.33 H	10% min.			0.9 W
	12 V	75 mA		160 Ω	0.73 H	1.37 H				
	24 V	37.7 mA		636 Ω	3.20 H	5.72 H				
	48 V*	18.8 mA		2,560 Ω	10.60 H	21.0 H				
	100/110 V	9.0/9.9 mA		11,100 Ω	45.60 H	86.2 H				

Note: 1. The rated current and coil resistance are measured at a coil temperature of 23°C with tolerances of +15%/–20% for rated currents and ±15% for DC coil resistance.

2. Performance characteristic data are measured at a coil temperature of 23°C.

3. AC coil resistance and impedance are provided as reference values (at 60 Hz).
4. Power consumption drop was measured for the above data. When driving transistors, check leakage current and connect a bleeder resistor if required.
5. Rated voltage denoted by “**” will be manufactured upon request. Ask your OMRON representative.

■ Contact Ratings

Item	2-pole		4-pole		4-pole (bifurcated)	
	Resistive load ($\cos\phi = 1$)	Inductive load ($\cos\phi = 0.4$, L/R = 7 ms)	Resistive load ($\cos\phi = 1$)	Inductive load ($\cos\phi = 0.4$, L/R = 7 ms)	Resistive load ($\cos\phi = 1$)	Inductive load ($\cos\phi = 0.4$, L/R = 7 ms)
Rated load	5A, 250 VAC 5A, 30 VDC	2A, 250 VAC 2 A, 30 VDC	3 A, 250 VAC 3 A, 30 VDC	0.8 A, 250 VAC 1.5 A, 30 VDC	3 A, 250 VAC 3 A, 30 VDC	0.8 A, 250 VAC 1.5 A, 30 VDC
Carry current	10 A (see note)		5 A (see note)			
Max. switching voltage	250 VAC 125 VDC		250 VAC 125 VDC			
Max. switching current	10 A		5 A			
Max. switching capacity	2,500 VA 300 W	1,250 VA 300 W	1,250 VA 150 W	500 VA 150 W	1,250 VA 150 W	500 VA 150 W

Note: Don't exceed the carry current of a Socket in use.

■ Characteristics

Item	All Relays
Contact resistance	100 mΩ max.
Operate time	20 ms max.
Release time	20 ms max.
Max. operating frequency	Mechanical: 18,000 operations/hr Electrical: 1,800 operations/hr (under rated load)
Insulation resistance	1,000 MΩ min. (at 500 VDC)
Dielectric withstand voltage	2,000 VAC, 50/60 Hz for 1.0 min (1,000 VAC between contacts of same polarity)
Vibration resistance	Destruction: 10 to 55 Hz, 1.0-mm double amplitude Malfunction: 10 to 55 Hz, 1.0-mm double amplitude
Shock resistance	Destruction: 1,000 m/s ² (approx. 100G) Malfunction: 200 m/s ² (approx. 20G)
Life expectancy	See the following table.
Ambient temperature	Operating: -55°C to 70°C (with no icing)
Ambient humidity	Operating: 35% to 85%
Weight	Approx. 35 g

Note: The values given above are initial values.

■ Life Expectancy Characteristics

Pole	Mechanical life (at 18,000 operations/hr)	Electrical life (at 1,800 operations/hr under rated load)
2-pole	AC: 50,000,000 operations min.	500,000 operations min.
4-pole	DC: 100,000,000 operations min.	200,000 operations min.
4-pole (bifurcated)	20,000,000 operations min.	100,000 operations min.

■ Approved Standards

VDE, UL, CSA, IMQ

Engineering Data

Maximum Switching Capacity

MY2

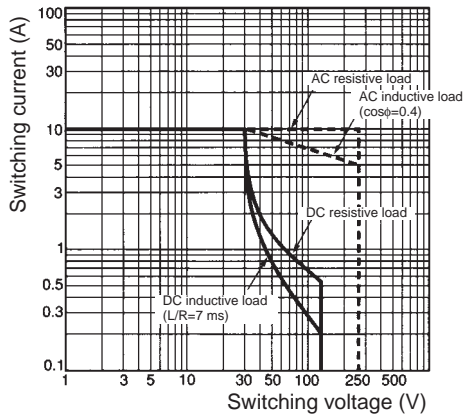

MY4, MY4Z

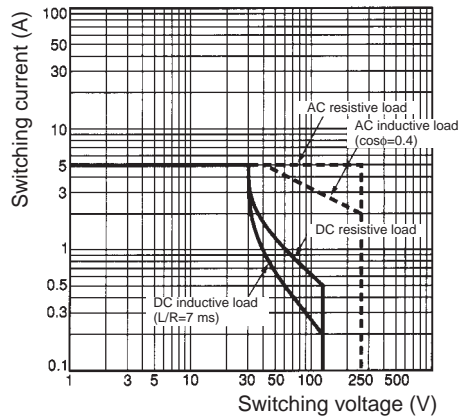

Life Expectancy

MY2 (Resistive Loads)

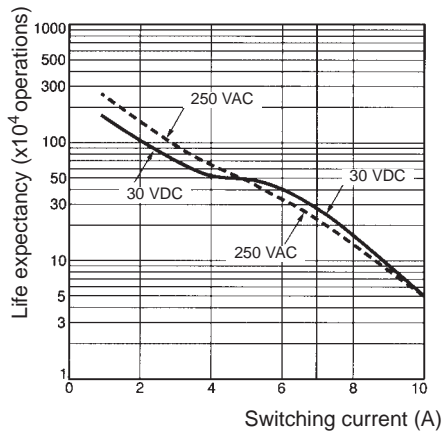

MY2 (Inductive Loads)

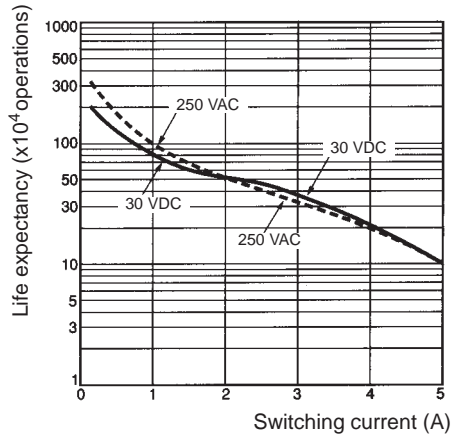

MY4 (Resistive Loads)

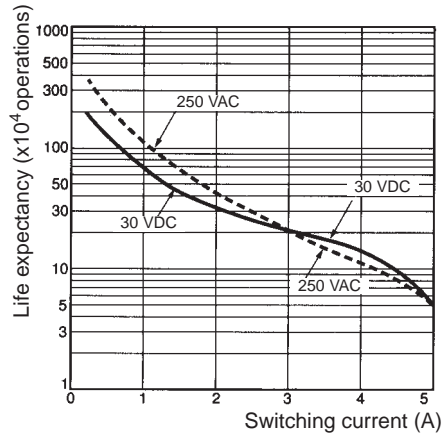

MY4 (Inductive Loads)

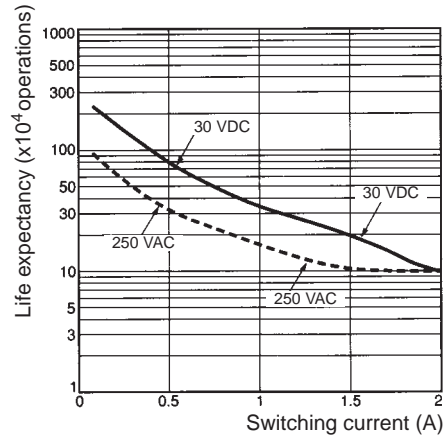

MY4Z (Resistive Loads)

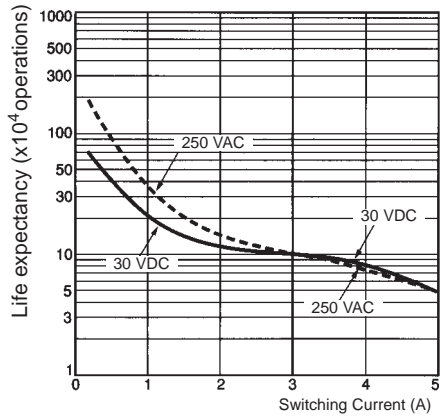

MY4Z (Inductive Loads)

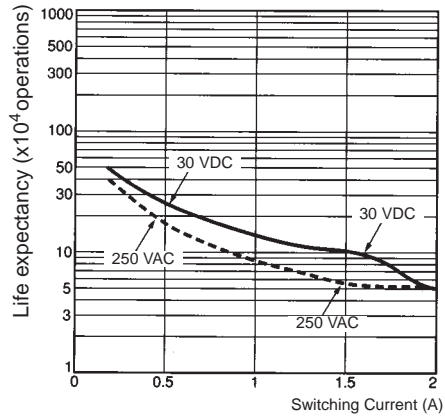

Dimensions

Note: All units are in millimeters unless otherwise indicated.

2-Pole Models

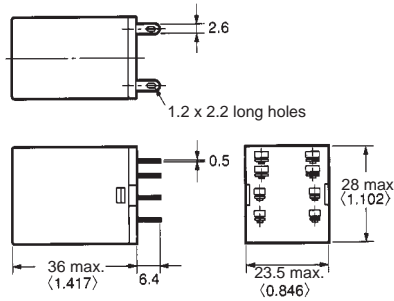
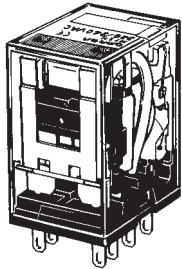

4-Pole Models

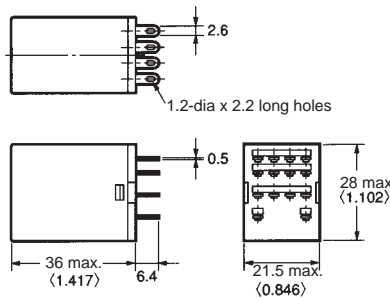
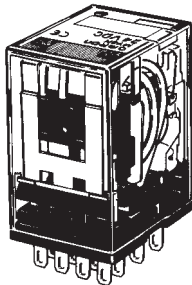

Models with Test Button

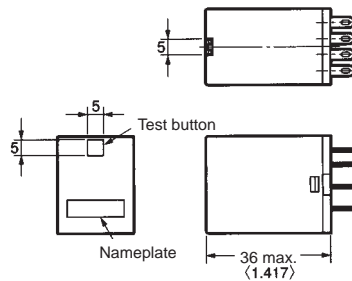
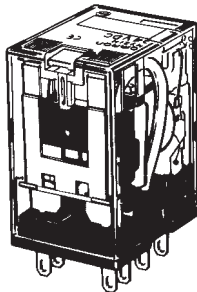

■ Terminal Arrangement/Internal Connections (Bottom View)

MY2

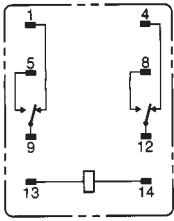

MY2N/MY2IN
(AC Models)

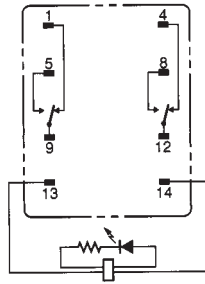

MY2N/MY2IN
(DC Models)

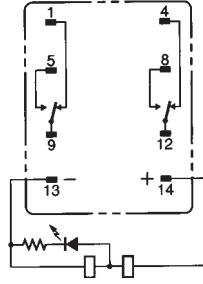

MY2N-D2/MY2IN-D2
(DC Models Only)

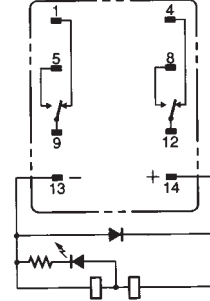

MY2N-CR/MY2IN-CR
(AC Models Only)

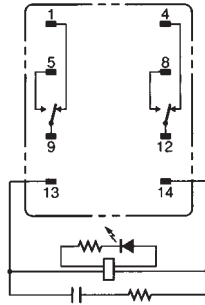

MY2N1/MY2IN1
(DC Models Only)

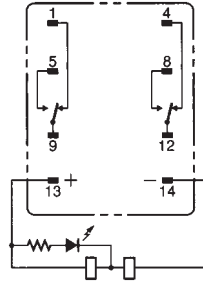

MY2N1-D2/MY2IN1-D2
(DC Models Only)

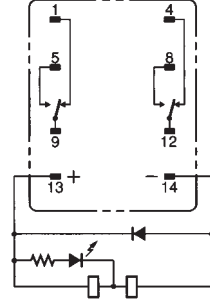

MY4(Z)

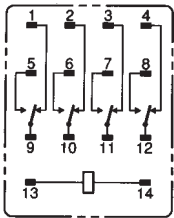

MY4(Z)N/MY4(Z)IN
(AC Models)

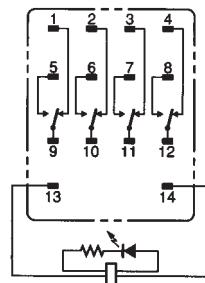

MY4(Z)N/MY4(Z)IN
(DC Models)

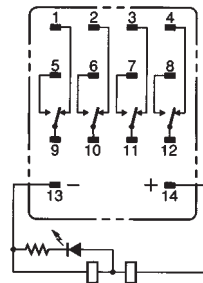

MY4(Z)N-D/MY4(Z)IN-D2
(DC Models Only)

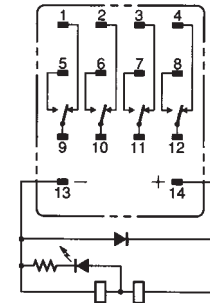

MY4(Z)N-CR/MY4(Z)IN-CR
(AC Models Only)

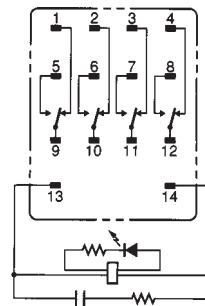

MY4(Z)N1/MY4(Z)IN1
(DC Models Only)

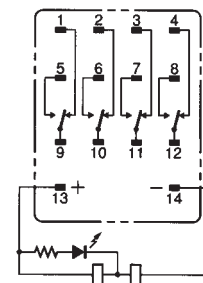

MY4(Z)N1-D2/MY4(Z)IN1-D2
(DC Models Only)

