

OEM relative and absolute pressure transmitter type 511

Pressure range
-1 ... 0 – 600 bar



Type 511 pressure transmitters meet the highest specifications for longevity, accuracy, temperature stability and EMC characteristics, making them suitable for an extremely wide range of demanding industrial applications.

- Compact, rugged construction for highest operational reliability
- No media egress when exceeding rupture pressure
- Negligible temperature influence on accuracy
- Excellent EMC capacity
- Saving time by quick cable mounting by the customer with swift connector

Technical overview

Pressure range

Relative	-1 ... 0 – 600 bar
Absolute	0 ... 25 bar

Operating conditions

Medium		Liquids and gases	
Temperature	Ambient ¹⁾	FPM	-15 ... +125 °C
		EPDM	-40 ... +150 °C (UL max. 125 °C)
		NBR	-25 ... +125 °C
		ration. output, AMP JPT	max. +125 °C
		all other versions	max. +85 °C
Tolerable overload / Rupture pressure ²⁾	< 6	3.0 x fs	
	≥ 6	2.5 x fs (max. 900 bar)	

Materials

Case		Stainless steel 1.4305 / AISI 303
Materials in contact with the medium	Pressure connection	Stainless steel 1.4305 / AISI 303
	Sensor	Ceramic Al ₂ O ₃ (96%)
	Media stop system	PPS
	Sealing material	FPM, EPDM, NBR, FPM spec.

Media stop system

Huba-patented media stop system to prevent media egress when exceeding rupture pressure range (> 40 bar nominal value).

Electrical overview

2 wire	Output	Power supply	Load	Current consumption ⁴⁾
	4 ... 20 mA	8.0 ... 33 VDC	< $\frac{\text{supply voltage} - 8 \text{ V}}{0.02 \text{ A}}$ [Ohm]	< 20 mA
3 wire	0 ... 5 V	8.0 ... 33 VDC	>10 kOhm / < 100 nF	< 4 mA
	1 ... 6 V	8.0 ... 33 VDC	>10 kOhm / < 100 nF	< 4 mA
	0 ... 10 V	11.4 ... 33 VDC	>10 kOhm / < 100 nF	< 4 mA
	0 ... 10 V	24 VAC ±15%	>10 kOhm / < 100 nF	< 4 mA
	ration. 10 ... 90%	5 VDC ±5%	>10 kOhm / < 100 nF	< 4 mA
Polarity reversal protection	Short circuit proof and protected against polarity reversal. Each connection is protected against crossover up to max. supply voltage.			
Insulation voltage			standard	500 VDC
			optional	1000 VDC

Dynamic response

Response time	< 2 ms, typ. 1 ms
Load cycle	< 100 Hz

Protection standard

With connector DIN EN 175301-803-C	IP 65
All other versions	IP 67

Electrical connection

Cable 1.5 m
Swift connector
Connector AMP (Junior power time)
Connector M12x1 plastic thread
Connector M12x1 metal thread
Connector DIN EN 175301-803-C (industrial standard 9.4 mm)

Pressure connection

Inside thread	G ¼ with O-Ring seal
	G ¼ sealed at back, DIN 3852-E
	G ½ sealed at front
	G ½ sealed at back and manometer (combi)
	¼ -18 NPT
Outside thread	R ¼ EN 10226
	M12x1.5 sealed at back, DIN 3852-E
	M14x1.5 sealed at back, DIN 3852-E

Installation arrangement

Unrestricted

Tests / Admissions

Electromagnetic compatibility	CE conformity acc. EN 61326-2-3
UL	acc. Standard 61010-1
Shock acc. IEC 60068-2-27	100 g, 11 ms half sine wave, all 6 directions. Free fall from 2 m on concrete (6x)
Constant shock acc. IEC 60068-2-29	40 g for 6 ms, 1000x all 3 directions
Vibration acc. IEC 60068-2-6	20 g, 2 ... 2000 Hz with amplitude ± 15 mm, 1 Octave/min. all 3 directions, 50 constant load

Weight

Version with inside thread	~ 85 g
Version with outside thread	~ 95 g

Packaging (Please state on order)

Single packaging in cardboard	accessories integrated
Multiple packaging in cardboard (25 pcs)	accessories integrated

Accuracy

Parameter		Unit	
Tolerance zero point	max.	% fs	±0.3
Tolerance full scale	max.	% fs	±0.3
Resolution		% fs	0.1
Total of linearity, hysteresis and repeatability	max.	% fs	±0.3
Long term stability acc. DIN EN 60770		% fs	±1.0
TC zero point ⁴⁾	max.	% fs/10K	±0.15
TC sensitivity ⁴⁾	max.	% fs/10K	±0.15

Test conditions: 25 °C, 45% RH, power supply 24 VDC
TC z.p. / TC s. -40 ... +125 °C

¹⁾ Version until +150 °C on request

²⁾ higher overload and rupture pressure on request

³⁾ at nominal pressure

⁴⁾ TC = Temperature coefficient

Order code selection table in bar				1	2	3	4	5	6	7	8	9	10			
				511.	X	X	X	X	X	X	X	X	X			
Pressure mode	Relative			9												
	Absolute			8												
Pressure range ¹⁾	-1 ... 0 bar			9	0	0										
	0 ... 1 bar				1	1										
	0 ... 1.6 bar				1	2										
	0 ... 2.5 bar				1	4										
	0 ... 4 bar				1	5										
	0 ... 6 bar				1	7										
	0 ... 10 bar				3	0										
	0 ... 16 bar				3	1										
	0 ... 25 bar				3	2										
	0 ... 40 bar			9	3	3							2			
	0 ... 60 bar			9	4	0							2			
	0 ... 100 bar			9	4	1							2,5			
	0 ... 160 bar			9	4	2							2,5			
	0 ... 250 bar			9	4	3							2,5			
	0 ... 400 bar (FPM seal only -40 ... +150 °C)			9	5	4	6						2,5			
	0 ... 600 bar (FPM seal only -40 ... +150 °C)			9	5	5	6						2,5			
	▲ Full scale signal at these pressures															
Sealing material ²⁾	FPM	Fluoro elastomer	-15 ... +125 °C						0							
			-40 ... +150 °C (UL max. 125 °C)						6							
	EPDM	Ethylene propylene							1							
	NBR	Butadiene Acrylonitrile							2							
Adjustment	Factory								0							
Output / power supply	0 ... 5 V	8.0 ... 33 VDC	IN=1 / OUT=3 / GND=4									1				
		8.0 ... 33 VDC	IN=1 / OUT=4 / GND=3									F	5,7			
	1 ... 6 V	8.0 ... 33 VDC	IN=1 / OUT=3 / GND=4										6			
		8.0 ... 33 VDC	IN=1 / OUT=4 / GND=3										G	5,7		
	0 ... 10 V	11.4 ... 33 VDC	IN=1 / OUT=3 / GND=4										2			
		11.4 ... 33 VDC	IN=1 / OUT=4 / GND=3										H	5,7		
	4 ... 20 mA	8.0 ... 33 VDC											7	1,0		
ration. 10 ... 90%	5 VDC ±5%											3				
												4				
Electrical connection	Cable 1.5 m												0			
	Swift connector													1		
	Connector	AMP JPT ³⁾												2		
		M12x1 plastic thread ³⁾													5	
		M12x1 metal thread ³⁾													7	
DIN EN 175301-803-C		2 w: IN=3 / OUT=1 3 w: IN=3 / OUT=2 / GND=1											8			
	DIN EN 175301-803-C		2 w: IN=1 / OUT=2 3 w: IN=1 / OUT=3 / GND=2											9		
Pressure connection ⁴⁾	Inside thread	G ¼ with O-Ring seal (no pressure tip orifice possible)											1	1,2		
		G ¼ sealed at back, DIN 3852-E												4		
		G ½ sealed at front												9		
	Outside thread	G ½ sealed at back and manometer (combi)												8		
		¼ -18 NPT												3		
		R ¼, EN 10226												7		
		M12x1.5 sealed at back, DIN 3852-E												5		
	M14x1.5 sealed at back, DIN 3852-E												6			
Version	Stainless steel without media stopper (≤ 60 bar)													1		
	Stainless steel with media stopper (standard ≥ 40 bar)													2		
	Stainless steel with pressure tip orifice (≥ 100 bar)													5		
Pressure range variation (optional)	Indicate W and state range on order (e.g.: W0... + 8bar/OUT1...6V)													W		

Accessories		Order number
Female connector for connector M12x1		106975
Female connector AMP (Junior power timer) 2-wire		110442
Female connector AMP (Junior power timer) 3-wire		108767
Female connector swift connector	(included in delivery)	117312
Female connector		104244
Calibration certificate		104551

¹⁾ Other pressure range on request ²⁾ Other sealing material on request ³⁾ Delivery without female connector ⁴⁾ Other pressure connection on request

			1	2	3	4	5	6	7	8	9	10	
Order code selection table in psi			511. X X X X X X X X X X										
Pressure mode	Relative		9										
	Absolute		8										
Pressure range ¹⁾	-30 ... 0" hg		9	A	0								
	0 ... 15 psi			B	1								
	0 ... 30 psi			B	4								
	0 ... 60 psi			B	5								
	0 ... 100 psi			B	7								
	0 ... 200 psi			C	1								
	0 ... 300 psi			C	2								
	0 ... 500 psi			9	C	3						2	
	0 ... 750 psi			9	D	0						2	
	0 ... 1000 psi			9	D	1						2,5	
	0 ... 2000 psi			9	D	2						2,5	
	0 ... 3000 psi			9	D	3						2,5	
	0 ... 5000 psi (FPM seal only -40 ... +150 °C)			9	E	4	6					2,5	
	0 ... 7500 psi (FPM seal only -40 ... +150 °C)			9	E	5	6					2,5	
	▲ Full scale signal at these pressures												
Sealing material ²⁾	FPM	Fluoro elastomer						0					
								-15 ... +125 °C					
								-40 ... +150 °C (UL max. 125 °C)	6				
	EPDM	Ethylene propylene						1					
	NBR	Butadiene Acrylonitrile						2					
Adjustment	Factory							0					
Output / power supply	0 ... 5 V	8.0 ... 33 VDC	IN=1 / OUT=3 / GND=4						1				
		8.0 ... 33 VDC	IN=1 / OUT=4 / GND=3						F	5,7			
	1 ... 6 V	8.0 ... 33 VDC	IN=1 / OUT=3 / GND=4						6				
		8.0 ... 33 VDC	IN=1 / OUT=4 / GND=3						G	5,7			
	0 ... 10 V	11.4 ... 33 VDC	IN=1 / OUT=3 / GND=4						2				
		11.4 ... 33 VDC	IN=1 / OUT=4 / GND=3						H	5,7			
		24 VAC ±15%							7	1,0			
4 ... 20 mA	8.0 ... 33 VDC							3					
ration. 10 ... 90%	5 VDC ±5%							4					
Electrical connection	Cable 1.5 m										0		
	Swift connector										1		
	Connector	AMP JPT ³⁾										2	
		M12x1 plastic thread ³⁾										5	
		M12x1 metal thread ³⁾										7	
		DIN EN 175301-803-C		2 w: IN=3 / OUT=1	3 w: IN=3 / OUT=2 / GND=1							8	
DIN EN 175301-803-C		2 w: IN=1 / OUT=2	3 w: IN=1 / OUT=3 / GND=2							9			
Pressure connection ⁴⁾	Inside thread	G ¼ mit O-Ring seal (no pressure tip orifice possible)									1	1,2	
		G ¼ sealed at back, DIN 3852-E										4	
		G ½ sealed at front										9	
		G ½ sealed at back and manometer (combi)										8	
	Outside thread	¼ -18 NPT										3	
		R ¼, EN 10226										7	
		M12x1.5 sealed at back, DIN 3852-E										5	
M14x1.5 sealed at back, DIN 3852-E											6		
Version	Stainless steel without media stopper (≤ 700 psi)											1	
	Stainless steel with media stopper (standard ≥ 500 psi)											2	
	Stainless steel with pressure tip orifice (≥ 1000 psi)											5	
Pressure range variation (optional)	Indicate W and state range on order (e.g.: W0... + 120psi/OUT1...6V)										W		

¹⁾ Other pressure range on request

²⁾ Other sealing material on request

³⁾ Delivery without female connector

⁴⁾ Other pressure connection on request

				1	2	3	4	5	6	7	8	9	10		
Order code selection table in MPa				511. X X X X X X X X X X											
Pressure mode	Relative			9											
	Absolute			8											
Pressure range ¹⁾	-0.1 ... 0 MPa			9	F	0									
	0 ... 0.1 MPa				G	1									
	0 ... 0.16 MPa				G	2									
	0 ... 0.25 MPa				G	4									
	0 ... 0.4 MPa				G	5									
	0 ... 0.6 MPa				G	7									
	0 ... 1 MPa				H	0									
	0 ... 1.6 MPa				H	1									
	0 ... 2.5 MPa				H	2									
	0 ... 4 MPa			9	H	3							2		
	0 ... 6 MPa			9	K	0							2		
	0 ... 10 MPa			9	K	1							2,5		
	0 ... 16 MPa			9	K	2							2,5		
	0 ... 25 MPa			9	K	3							2,5		
	0 ... 40 MPa (FPM seal only -40 ... +150 °C)			9	L	4	6						2,5		
	0 ... 60 MPa (FPM seal only -40 ... +150 °C)			9	L	5	6						2,5		
▲ Full scale signal at these pressures															
Sealing material ²⁾	FPM	Fluoro elastomer	-15 ... +125 °C			0									
			-40 ... +150 °C (UL max. 125 °C)			6									
	EPDM	Ethylene propylene				1									
	NBR	Butadiene Acrylonitrile				2									
Adjustment	Factory							0							
Output / power supply	0 ... 5 V	8.0 ... 33 VDC	IN=1 / OUT=3 / GND=4							1					
		8.0 ... 33 VDC	IN=1 / OUT=4 / GND=3							F	5,7				
	1 ... 6 V	8.0 ... 33 VDC	IN=1 / OUT=3 / GND=4								6				
		8.0 ... 33 VDC	IN=1 / OUT=4 / GND=3								G	5,7			
	0 ... 10 V	11.4 ... 33 VDC	IN=1 / OUT=3 / GND=4								2				
		11.4 ... 33 VDC	IN=1 / OUT=4 / GND=3								H	5,7			
			24 VAC ±15%								7	1,0			
	4 ... 20 mA	8.0 ... 33 VDC									3				
ration. 10 ... 90%	5 VDC ±5%									4					
Electrical connection	Cable 1.5 m											0			
	Swift connector											1			
	Connector	AMP JPT ³⁾										2			
		M12x1 plastic thread ³⁾											5		
		M12x1 metal thread ³⁾											7		
		DIN EN 175301-803-C		2 w: IN=3 / OUT=1	3 w: IN=3 / OUT=2 / GND=1								8		
		DIN EN 175301-803-C		2 w: IN=1 / OUT=2	3 w: IN=1 / OUT=3 / GND=2								9		
Pressure connection ⁴⁾	Inside thread	G ¼ with O-Ring seal (no pressure tip orifice possible)											1	1,2	
		G ¼ sealed at back, DIN 3852-E												4	
	G ½ sealed at front												9		
	G ½ sealed at back and manometer (combi)												8		
	Outside thread	¼ -18 NPT												3	
		R ¼, EN 10226												7	
		M12x1.5 sealed at back, DIN 3852-E												5	
		M14x1.5 sealed at back, DIN 3852-E												6	
Version	Stainless steel without media stopper (≤ 6 MPa)												1		
	Stainless steel with media stopper (standard ≥ 4 MPa)												2		
	Stainless steel with pressure tip orifice (≥ 10 MPa)												5		
Pressure range variation (optional)	Indicate W and state range on order (e.g.: W0... + 0.8MPa/OUT1...6V)													W	

¹⁾ Other pressure range on request

²⁾ Other sealing material on request

³⁾ Delivery without female connector

⁴⁾ Other pressure connection on request

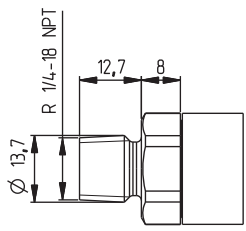

G 1/4
Inside thread

Female connector
swift connector

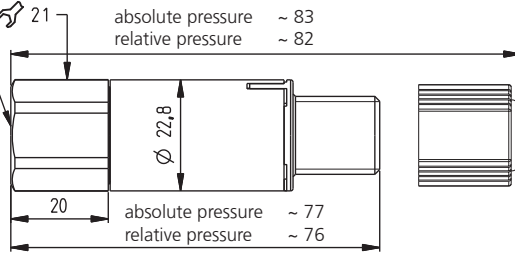

2 wire
(4 ... 20 mA)

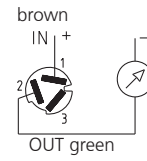

3 wire

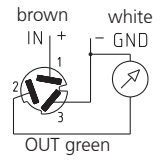

All absolute versions
are especially marked
with an indentation.

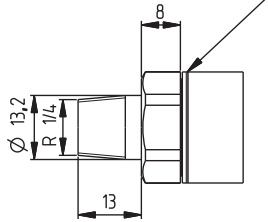

Female connector M12x1

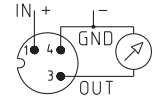
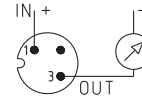
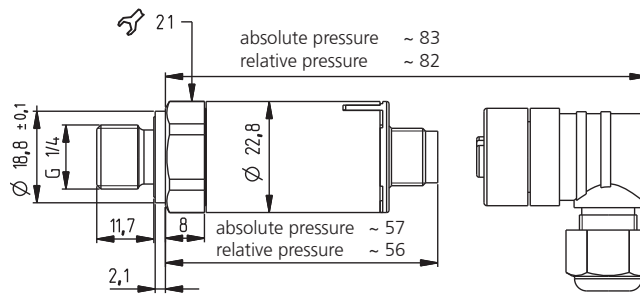

Female connector AMP JPT

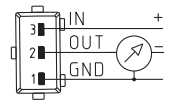
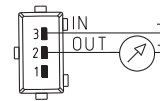
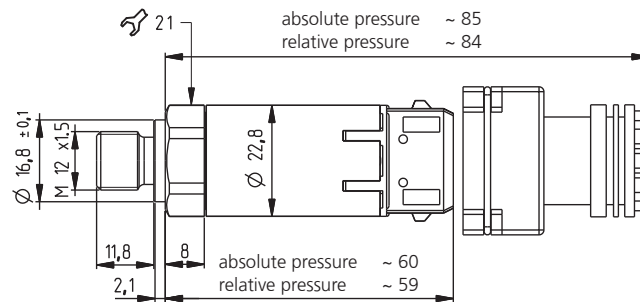
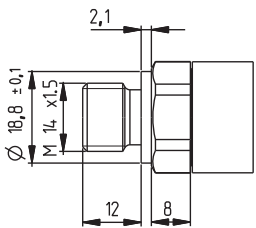

Female connector
DIN EN 175301-803-C

