



# Self Priming Centrifugal Pump

## Model T2A60-B

Size 2" x 2"

VARIOUS PATENTS APPLY

### PUMP SPECIFICATIONS

**Size:** 2" x 2" (51 mm x 51 mm) NPT - Female.

**Casing:** Gray Iron 30.

Maximum Operating Pressure 79 psi (545 kPa).\*

**Semi-Open Type, Two Vane Impeller:** Ductile Iron 65-45-12.

Handles 1 1/2" (38 mm) Diameter Spherical Solids.

**Impeller Shaft:** Alloy Steel 4150.

**Shaft Sleeve:** Alloy Steel 4130.

**Replaceable Wear Plate:** Carbon Steel 1026

**Removable Cover Plate:** Gray Iron 30; 13.6 lbs. (6 kg).

**Seal Plate:** Gray Iron 30.

**Externally Replaceable Flap Valve:** Neoprene <sup>w</sup>/Steel Reinforcing.

**Bearing Housing:** Gray Iron 30.

**Radial Bearing:** Open Single Row Ball.

**Thrust Bearing:** Open Double Row Ball.

**Bearing and Seal Cavity Lubrication:** SAE 30 Non-Detergent Oil.

**Flanges:** Gray Iron 30.

**Gaskets:** Buna-N, Vegetable Fiber, Cork and Rubber.

**O-Rings:** Buna-N.

**Internal Wetted Hardware:** Standard Plated Steel.

**External Hardware:** Standard Plated Steel.

**Brass Pressure Relief Valve.**

**Bearing and Seal Cavity Oil Level Sight Gauges.**

**Optional Equipment:** Automatic Air Release Valve.

120V/240V Casing Heater. High Pump Temperature Shutdown Kit. GR Hard Iron Seal Plate. Self-Cleaning Wear Plate. Hardened Steel Wear Plate. Aflas Seal. Self-Cleaning Wear Plate.

Gray Iron 30 Suction and Discharge Spool Flanges:

2" ASA (**Specify Model T2A60-B /F**).

50 mm DIN 2527 (PN 16) (**Specify Model T2A60-B /FM**).

\*Consult Factory for Applications Exceeding Maximum Pressure and/or Temperature Indicated.



Shown with Optional Suction & Discharge Spool Flanges (Available in ASA or DIN Standard Sizes).

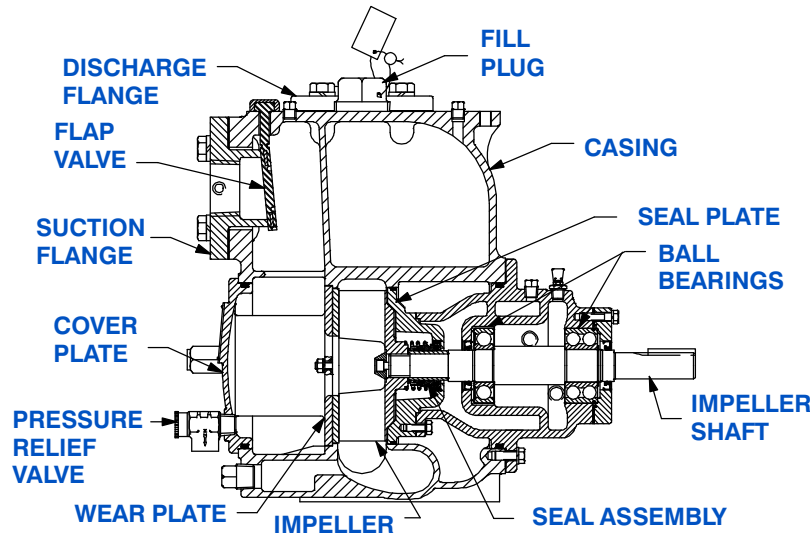
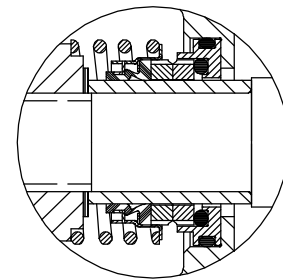

### SEAL DETAIL

Mechanical, Oil-Lubricated, Double Floating, Self-Aligning. Silicon Carbide Rotating and Stationary Faces. Stainless Steel 316 Stationary Seat. Fluorocarbon Elastomers (DuPont Viton<sup>®</sup> or Equivalent). Stainless Steel 18-8 Cage and Spring. Maximum Temperature of Liquid Pumped, 160°F (71°C).\*



GORMAN-RUPP PUMPS

www.grpumps.com

Specifications Subject to Change Without Notice

Printed in U.S.A.

**Specification Data**

**APPROXIMATE DIMENSIONS and WEIGHTS**

**NET WEIGHT: 210 LBS. (95 KG.)\***  
**SHIPPING WEIGHT: 220 LBS. (10 KG.)\***  
**EXPORT CRATE: 7.9 CU. FT. (0,22 CU. M.)**  
**\*ADD 8 LBS. (3,6 KG.) W/EACH SPOOL FLANGE**

SECTION 55, PAGE 985

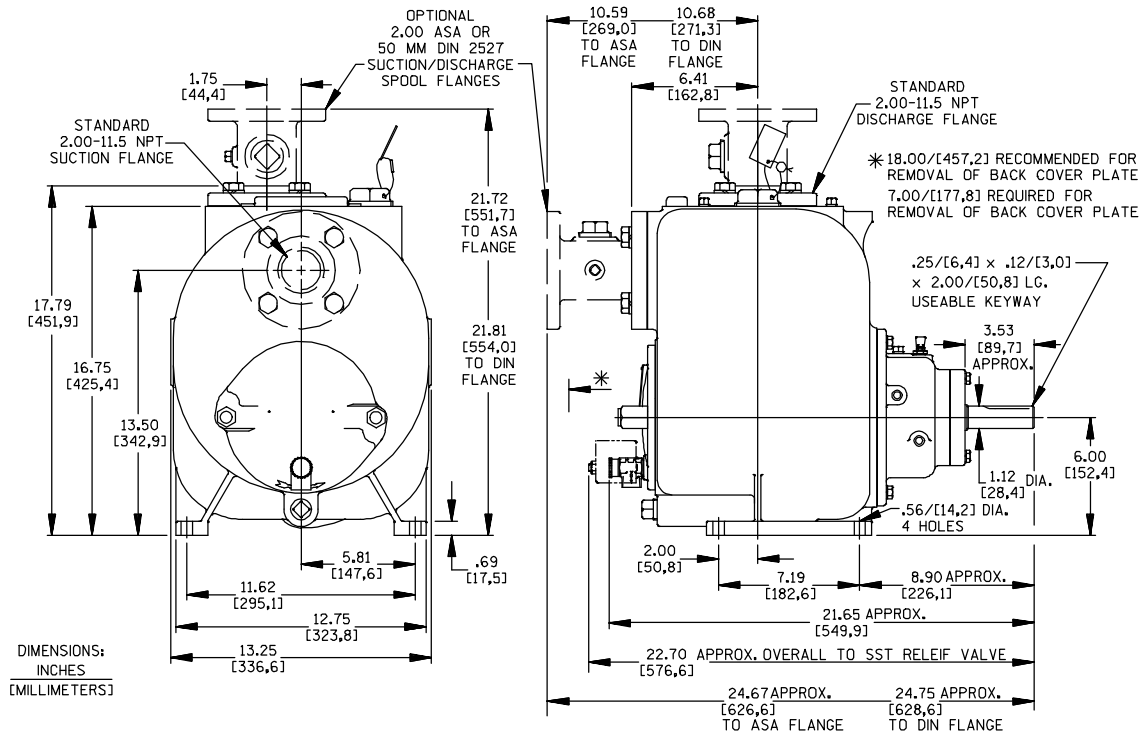

**OPTIONAL ASA OR DIN STANDARD SUCTION & DISCHARGE SPOOL FLANGES AVAILABLE**

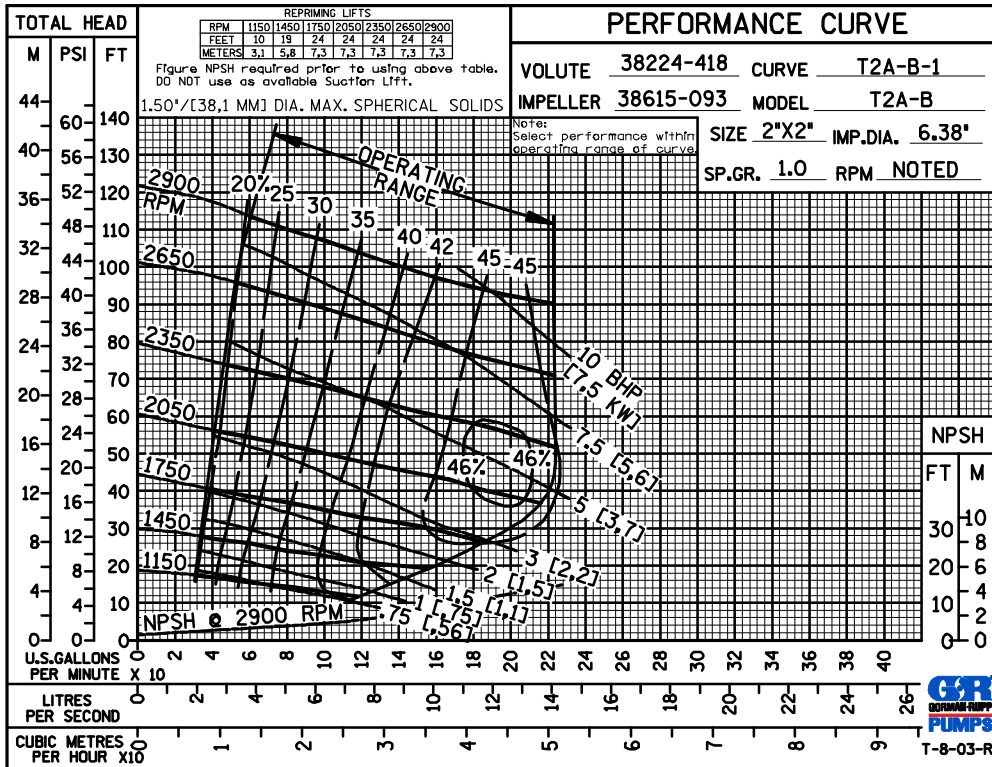

**GORMAN-RUPP PUMPS**

www.grpumps.com

Specifications Subject to Change Without Notice

Printed in U.S.A.

**MULTI-SPEED  
PERFORMANCE  
BASED ON  
WATER  
TRIMMED  
IMPELLER**

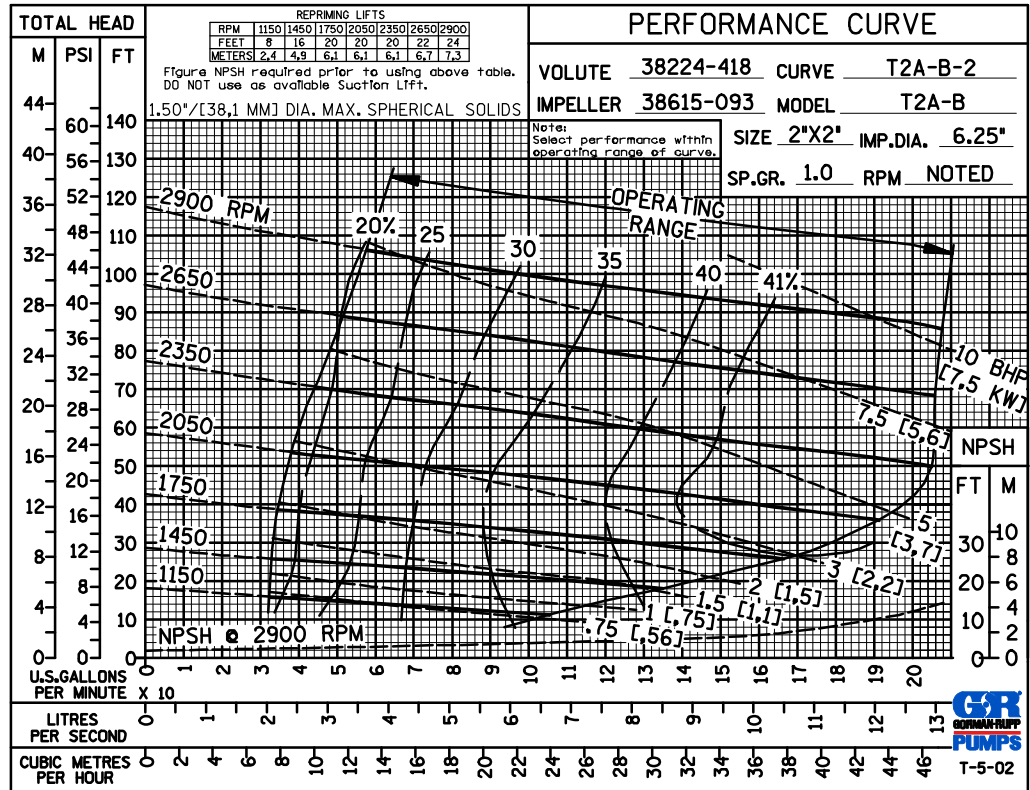

**MULTI-SPEED  
PERFORMANCE  
BASED ON  
WATER  
TRIMMED  
IMPELLER**

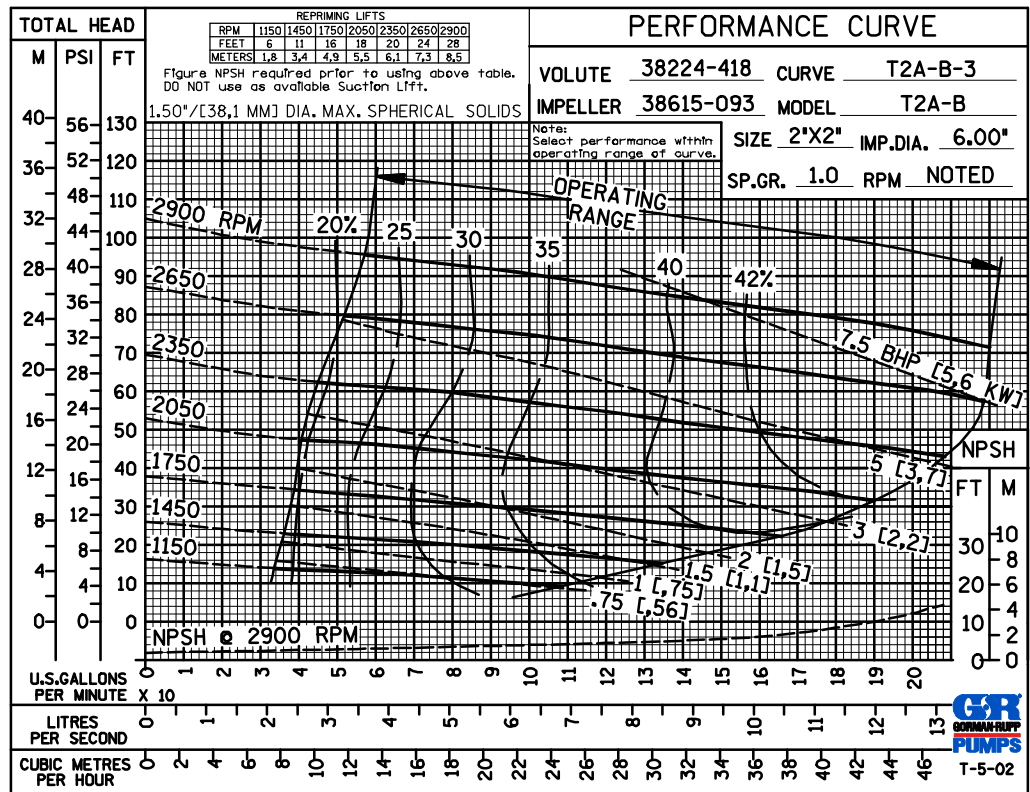

**GORMAN-RUPP PUMPS**

www.grpumps.com

Specifications Subject to Change Without Notice

Printed in U.S.A.

**MULTI-SPEED  
PERFORMANCE  
BASED ON  
WATER  
TRIMMED  
IMPELLER**

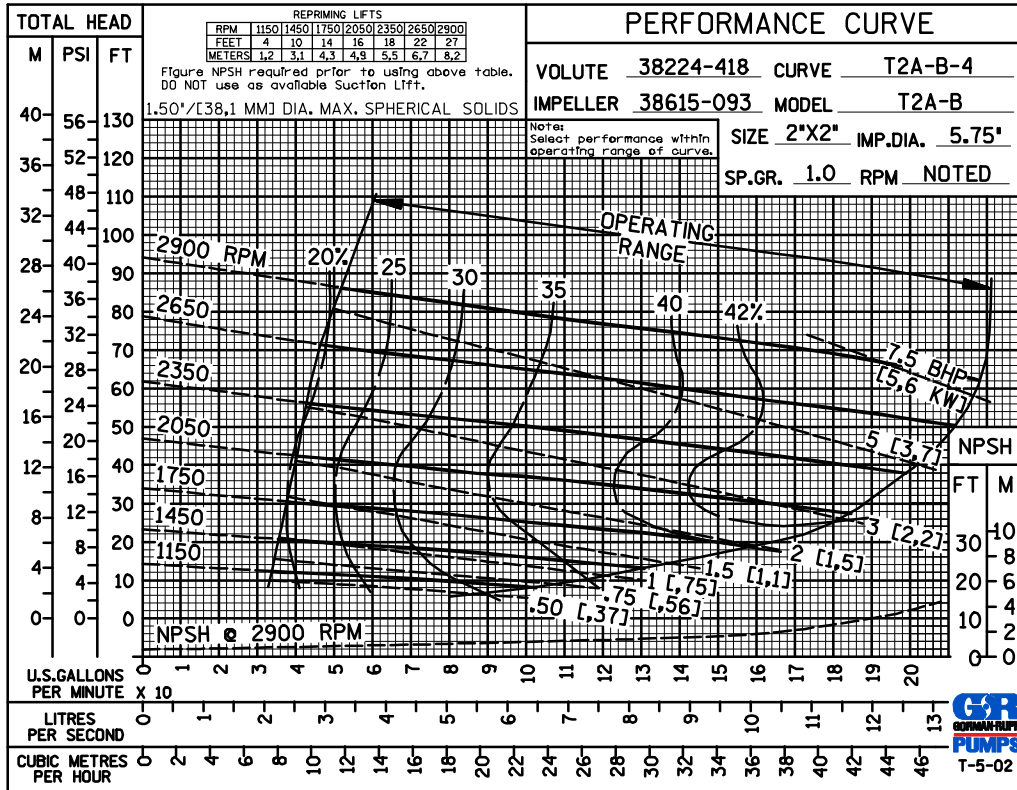

**MULTI-SPEED  
PERFORMANCE  
BASED ON  
WATER  
TRIMMED  
IMPELLER**

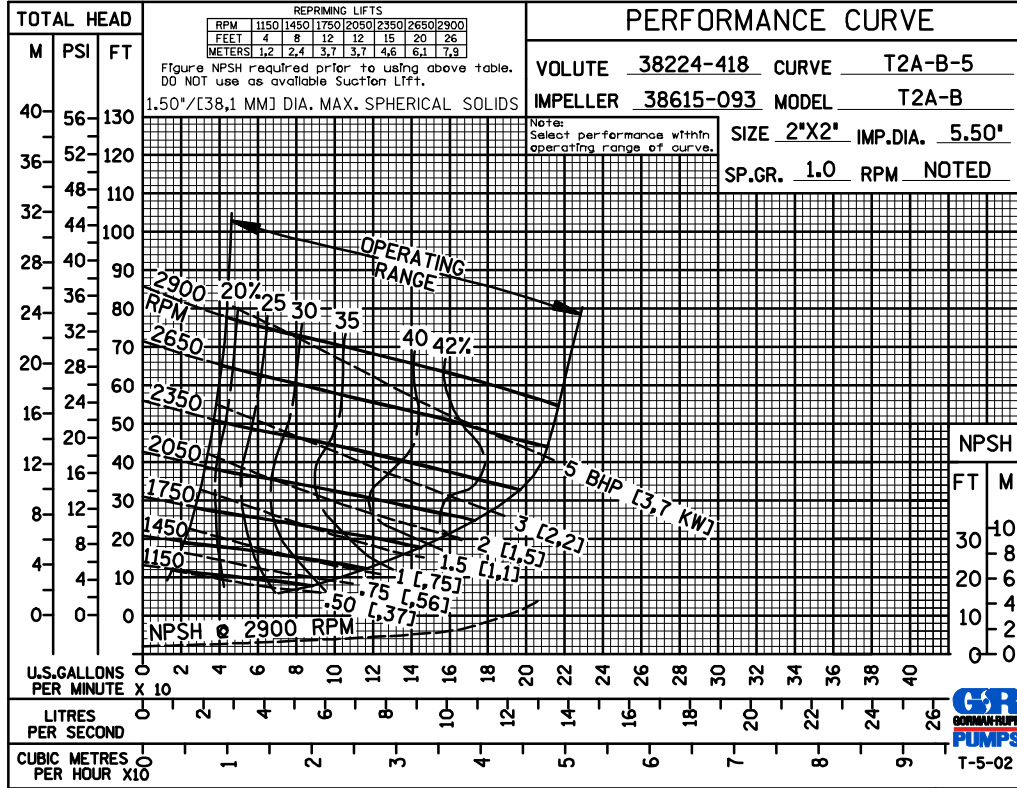

**GORMAN-RUPP PUMPS**

www.grpumps.com

Specifications Subject to Change Without Notice

Printed in U.S.A.

PERFORMANCE  
BASED ON  
WATER  
TRIMMED  
IMPELLER

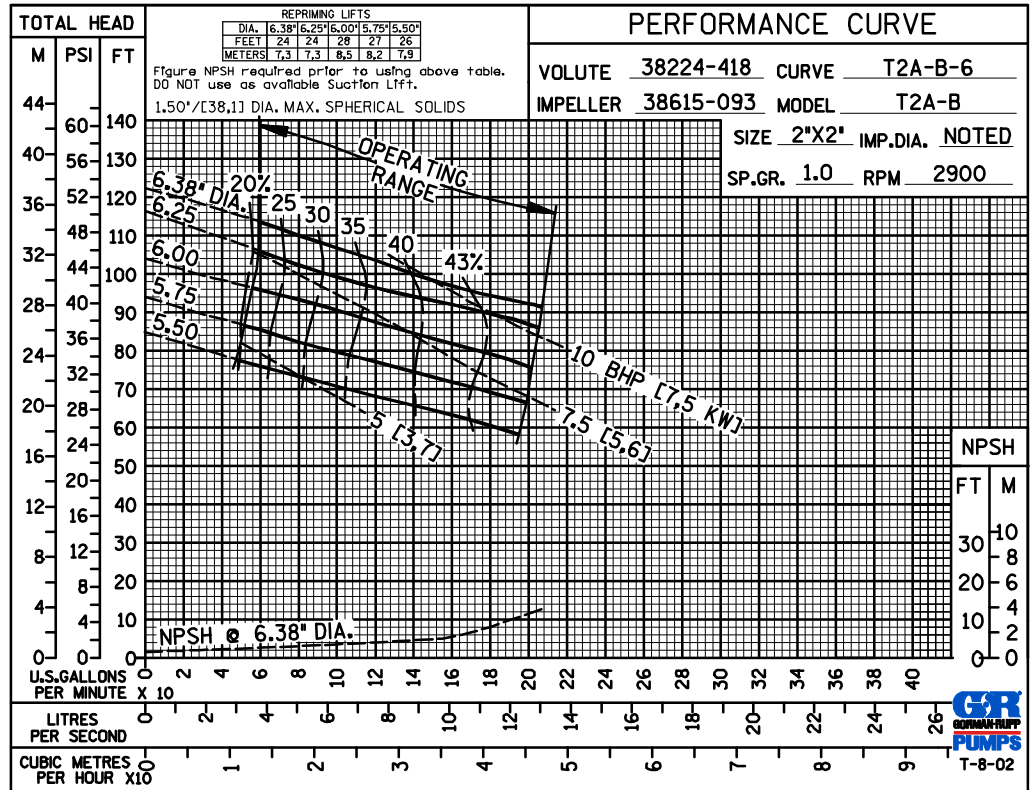

PERFORMANCE  
BASED ON  
WATER  
TRIMMED  
IMPELLER

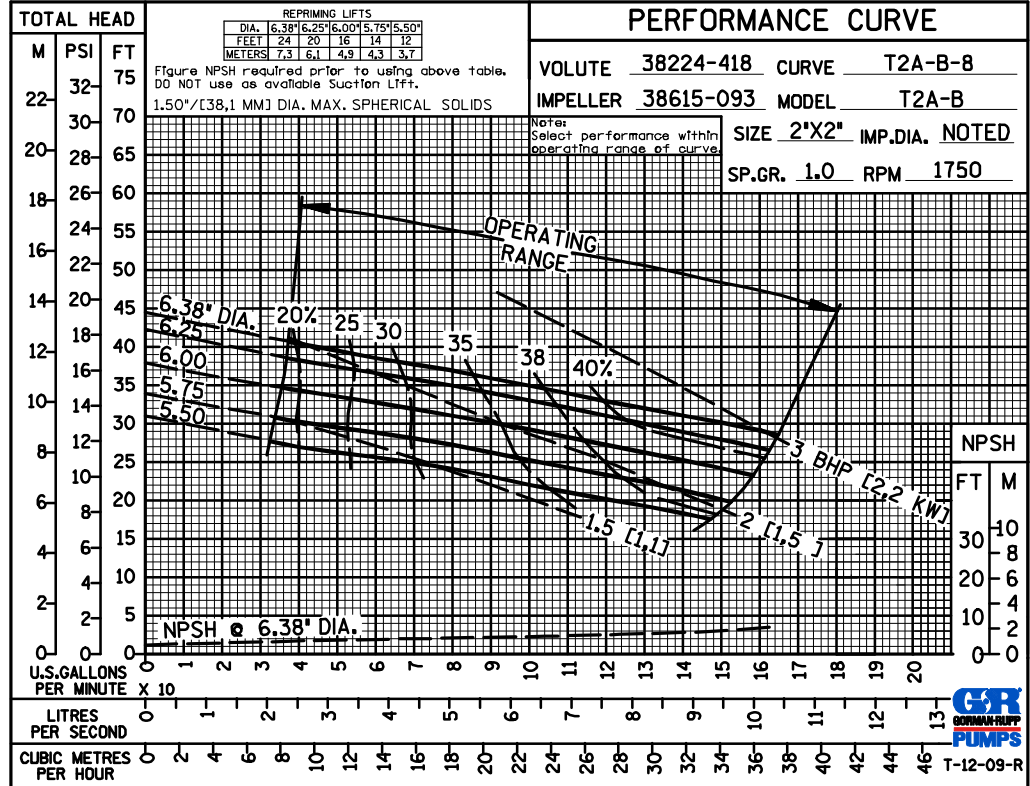

GORMAN-RUPP PUMPS

www.grpumps.com

Specifications Subject to Change Without Notice

Printed in U.S.A.

PERFORMANCE  
BASED ON  
WATER  
TRIMMED  
IMPELLER

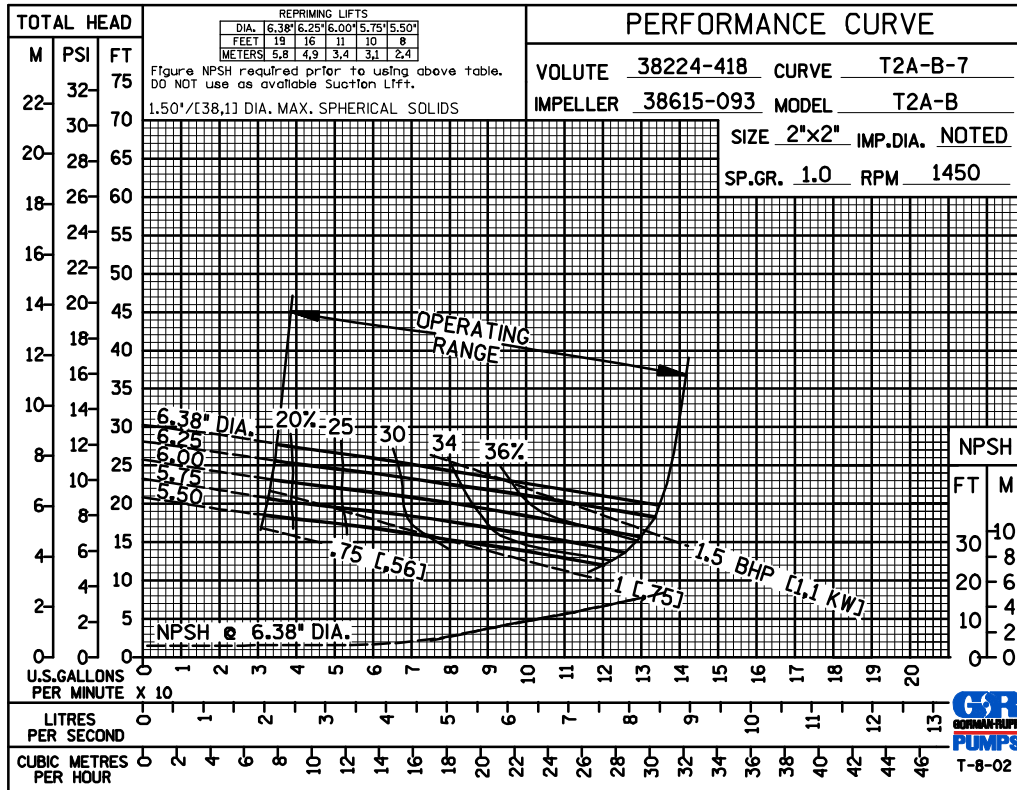

PERFORMANCE  
BASED ON  
WATER  
TRIMMED  
IMPELLER

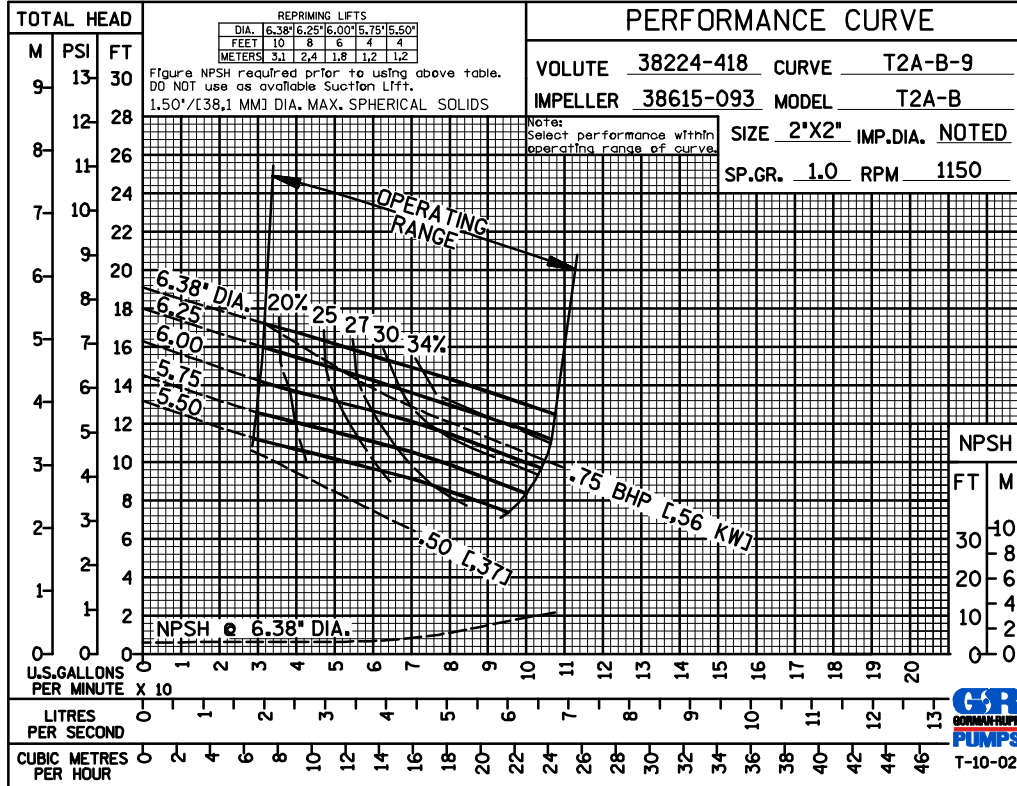

GORMAN-RUPP PUMPS

www.grpumps.com

Specifications Subject to Change Without Notice

Printed in U.S.A.

PERFORMANCE  
BASED ON  
WATER  
PUMPS IN  
PARALLEL

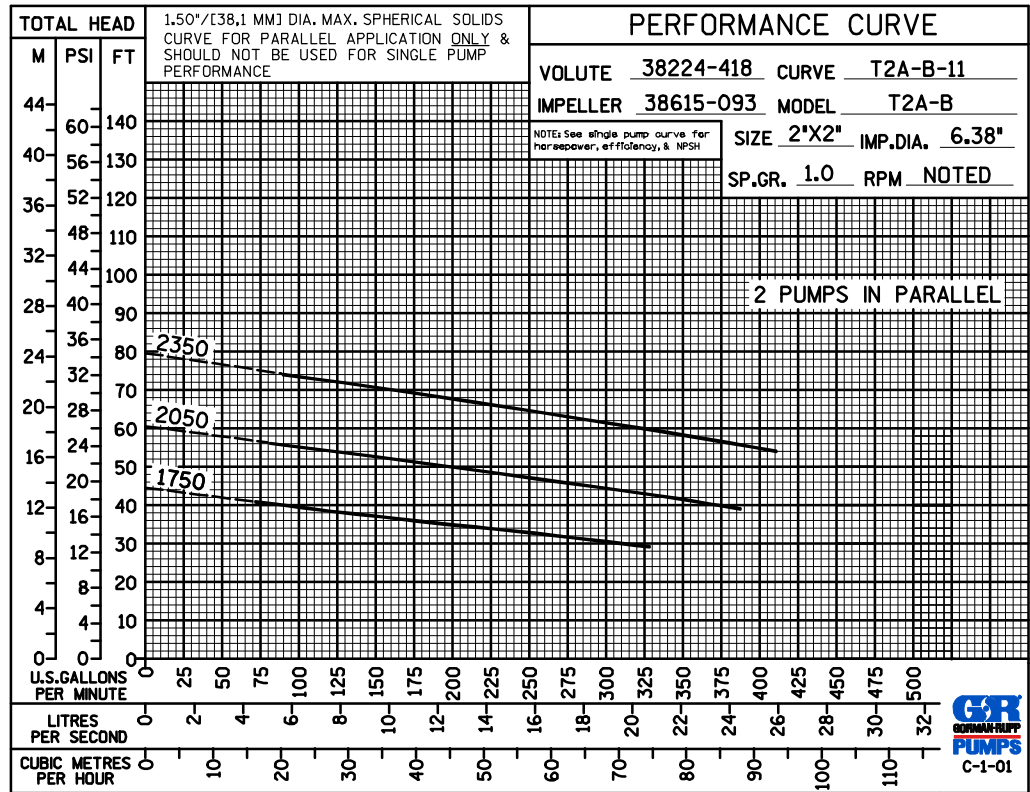

PERFORMANCE  
BASED ON  
WATER  
PUMPS IN  
SERIES

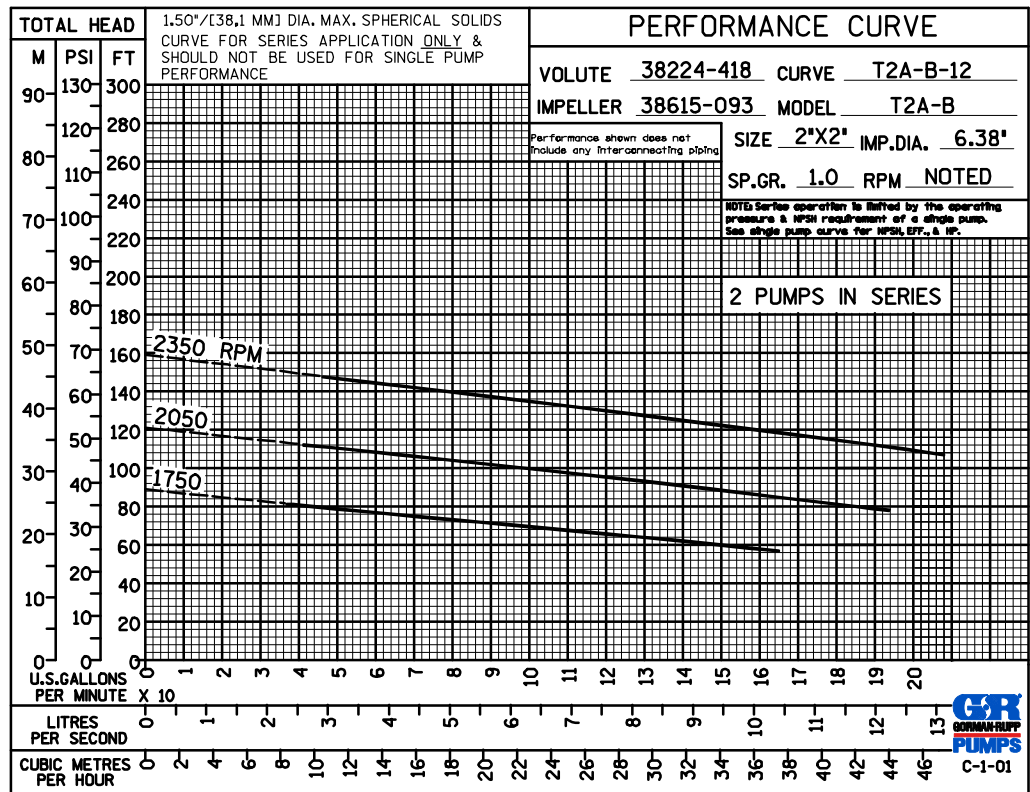

GORMAN-RUPP PUMPS

www.grpumps.com

Specifications Subject to Change Without Notice

Printed in U.S.A.