

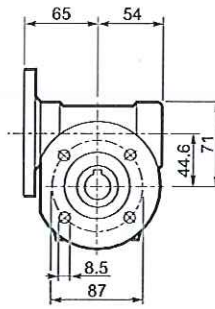

# VF 44...P (IEC)

**F**

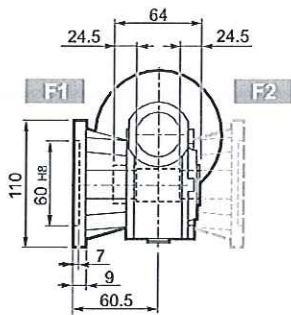

**FA**

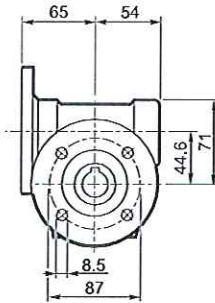
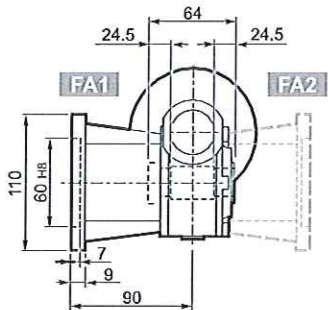

**U**

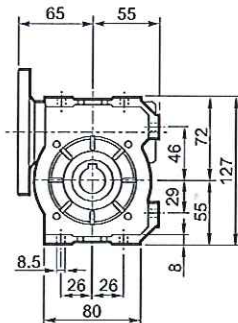
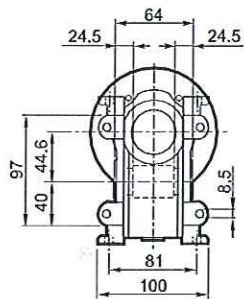

**INPUT**

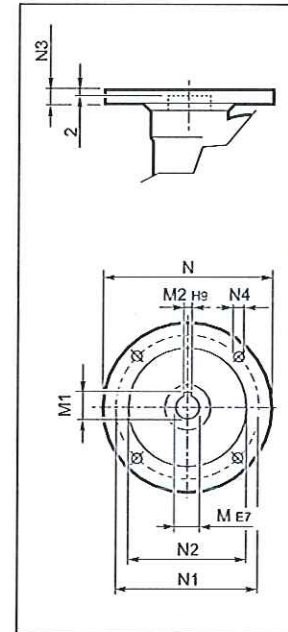

**OUTPUT**

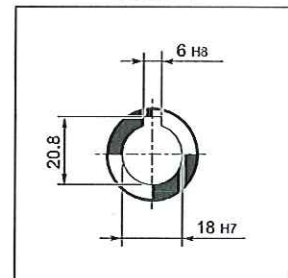

		M	M1	M2	N	N1	N2	N3	N4	
VF 44	P63 B5	11	12.8	4	140	115	95	10	9.5	2.0
VF 44	P71 B5	14	16.3	5	160	130	110	10	9.5	
VF 44	P63 B14	11	12.8	4	90	75	60	8	5.5	
VF 44	P71 B14	14	16.3	5	105	85	70	10	7	



**VF 44...P (IEC)**

**A**

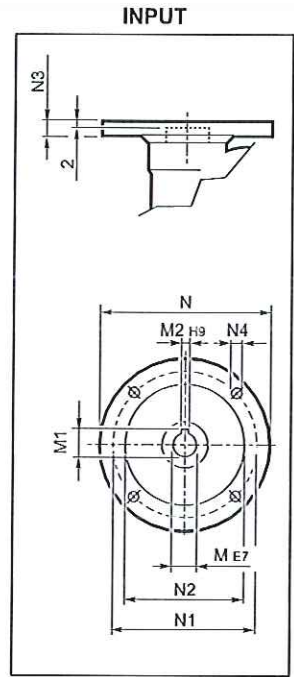
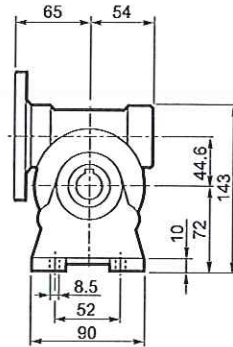
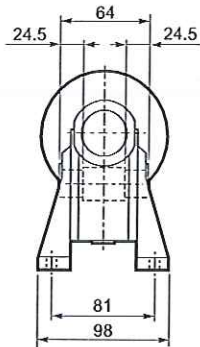

**N**

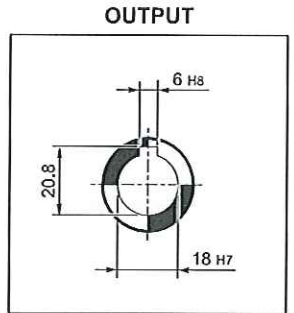
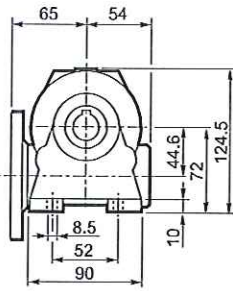
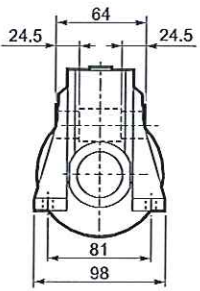

**V**

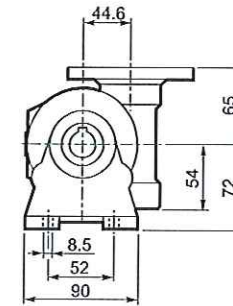
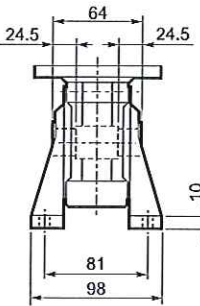

**P**

