

JUMO GmbH & Co. KG
 Delivery address: Mackenrodtstraße 14
 36039 Fulda, Germany
 Postal address: 36035 Fulda, Germany
 Phone: +49 661 6003-0
 Fax: +49 661 6003-607
 Email: mail@jumo.net
 Internet: www.jumo.net

JUMO Instrument Co. Ltd.
 JUMO House
 Temple Bank, Riverway
 Harlow, Essex CM20 2DY, UK
 Phone: +44 1279 635533
 Fax: +44 1279 635262
 Email: sales@jumo.co.uk
 Internet: www.jumo.co.uk

JUMO Process Control, Inc.
 6733 Myers Road
 East Syracuse, NY 13057, USA
 Phone: 315-437-5866
 1-800-554-5866
 Fax: 315-437-5860
 Email: info.us@jumo.net
 Internet: www.jumousa.com



JUMO dTRANS T01 HART[®] / T01T HART[®] / T01 Junior / T01 Ex / T01 HART[®] Ex Programmable 2-wire transmitter

for connection to RTD temperature probes and thermocouples
 for installation in : terminal head Form B to DIN 43729
 for mounting on : rail

Brief description

The 2-wire transmitter detects the temperature by means of an RTD temperature probe or a thermocouple. For RTD temperature probes, the probe can be connected in a 2-wire circuit, 3-wire circuit, or 4-wire circuit. The probe type, connection type, and measuring range can be configured using a setup program. The output signal 4 to 20 mA or reversed 20 to 4 mA is available in a linearized way (temperature linear).

The device is designed for industrial applications and complies with the respective European standards to guarantee electromagnetic compatibility (EMC).

The inexpensive version dTRANS T01 Junior type 707014/... supports a limited selection of RTD temperature probes and thermocouples. This type does not have a customer-specific linearization.

The versions 707015/... and 707016/... are electrical equipment for use in a potentially explosive area.

The transmitters JUMO dTRANS T01 (types 707011/..., 707013/... and 707016/...) can also be programmed using a HART[®] modem in conjunction with a PC setup program.



Type 707011/... (HART[®]),
 Type 707015/... (Ex),
 Type 707016/... (HART[®] Ex)



Type 707014/... (Junior)

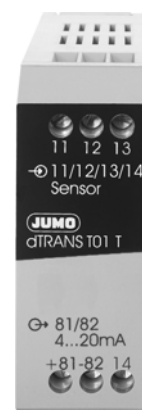

Type 707013/... (HART[®])

System diagrams



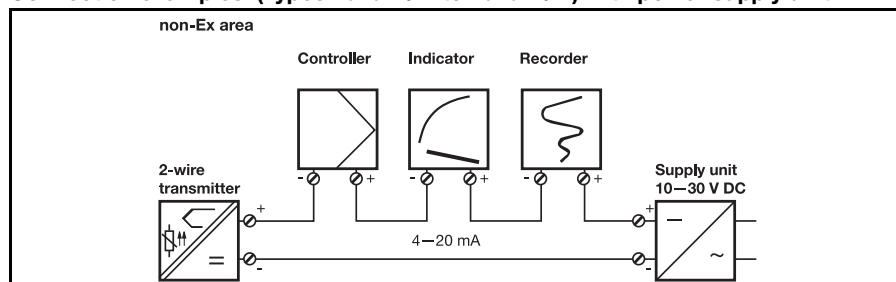

Connection examples (Types 707011/... to 707014/...) with power supply unit

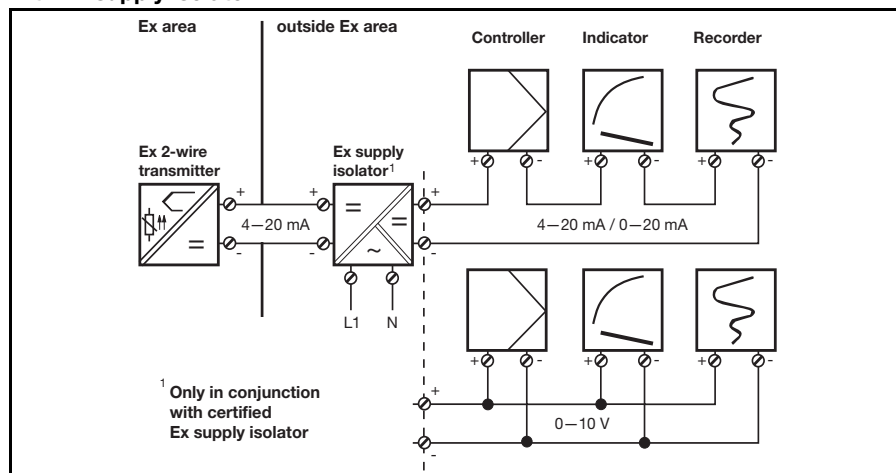

Connection examples (Types 707015/... and 707016/...) for Ex application with Ex supply isolator

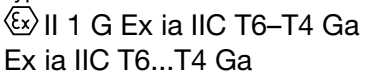

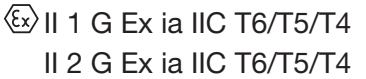
Features

- Types 707011/..., 707013/... and 707016/... with HART[®] interface
- Type 707015/... Ex and IECEx version

- Type 707016/... with HART[®] interface and as Ex version

- Type 707013/... in rail-mounting housing
- input and output electrically isolated
- freely configurable ranges
- customized linearization for RTD temperature probe and thermocouple (excepting 707014/...)

Technical data

Input for Thermocouple for the types 707011/..., 707013/..., 707015//..., 707016/...

Designation	Range limits	Accuracy ^a (typical)
Fe-CuNi „L“ DIN 43710 ^c	-200 ... +900 °C	typ. 0,5 K
Fe-CuNi „J“ DIN EN 60584	-210 ... +1200 °C	typ. 0,5 K above -150 °C
Cu-CuNi „U“ DIN 43710 ^c	-200 ... +600 °C	typ. 0,5 K
Cu-CuNi „T“ DIN EN 60584 ^c	-270 ... +400 °C	typ. 0,5 K above -200 °C
NiCr-Ni „K“ DIN EN 60584	-270 ... +1372 °C	typ. 0,5 K above -140 °C
NiCr-CuNi „E“ DIN EN 60584 ^c	-270 ... +1000 °C	typ. 0,5 K above -150 °C
NiCrSi-NiSi „N“ DIN EN 60584 ^c	-270 ... +1300 °C	typ. 1 K above -100 °C
Pt10Rh-Pt „S“ DIN EN 60584 ^c	-50 ... +1768 °C	typ. 2 K above 20 °C
Pt13Rh-Pt „R“ DIN EN 60584 ^c	-50 ... +1768 °C	typ. 2 K above 50 °C
Pt30Rh-Pt6Rh „B“ DIN EN 60584 ^c	0 ... 1820 °C	typ. 2 K above 400 °C
MoRe5-MoRe41 ^b	0 ... 2000 °C	typ. 2 K above 500 °C
W3Re-W25Re „D“ ^c	0 ... 2495 °C	typ. 1 K above 500 °C
W5Re-W26Re „C“ ^c	0 ... 2320 °C	typ. 1 K above 500 °C
Shortest span	Type L, J, U, T, K, E, N: 50 K Type S, R, B: 500 K Type MoRe5-MoRe41, D, C: 500 K	
Cold junction	Pt100 internal or external cold junction (adjustable from 0 ... 80 °C)	
Cold junction accuracy	±1 K	
Sampling rate	>1 measurement per second	
Sensor current	350 nA	
Input filter	1st order digital filter; filter constant adjustable: - on Type 707015/... within the range 0 ... 125sec - on Types 707011/..., 707013/... and 707016/... within the range 0 ... 100 sec	
Features	also programmable in °F; freely programmable range limits; input isolated from output	

^a The accuracy refers to the maximum range span.

^b Only for type 707015/...

^c For type 707013/... on request only.

Input RTD temperature probe for the types 707011/..., 707013/..., 707015/..., 707016/...

Designation	Range limits	Range	Accuracy ^a
Pt100 DIN EN 60751	-200 ... +850 °C	-100 ... +200 °C -200 ... +850 °C	±0,2 K ±0,4 K
Pt100 JIS	-200 ... +649 °C	-100 ... +200 °C -200 ... +649 °C	±0,2 K ±0,4 K
Pt500 DIN	-200 ... +250 °C	-100 ... +200 °C -200 ... +250 °C	±0,2 K ±0,4 K
Pt1000 DIN	-200 ... +250 °C	-100 ... +200 °C -200 ... +250 °C	±0,2 K ±0,4 K
Ni100	-60 ... +250 °C	-60 ... +250 °C	±0,2 K
Ni500	-60 ... +150 °C	-60 ... +150 °C	±0,2 K
Ni1000	-60 ... +150 °C	-60 ... +150 °C	±0,2 K
Connection circuit	2-,3- or 4-wire circuit		
Shortest span	10 K		
Sensor lead resistance - for 3-, 4-wire connection - for 2-wire connection	≤ 11Ω per conductor measuring resistance + ≤22 Ω internal lead resistance		
Sensor current	< 0,6 mA		
Sampling rate	> 1 measurement per second		
Input filter	1st order digital filter; filter constant adjustable: - on type 707015/... within a range 0 ... 125s - on types 707011/..., 707013/... and 707016/... within a range 0 ... 100s		
Features	also programmable in °F; freely programmable range limits; input isolated from output		

^a The accuracy refers to the maximum range span.

Input thermocouple for the type 707014/...

Designation	Range limits	Accuracy ^a (typical)
Fe-CuNi „J“ DIN EN 60584	-210 ... +1200 °C	typ. 0,5K above -150 °C
NiCr-Ni „K“ DIN EN 60584	-270 ... +1372 °C	typ. 0,5K above -140 °C
NiCrSi-NiSi „N“ DIN EN 60584	-270 ... +1300 °C	typ. 1K above -100 °C
Pt10Rh-Pt „S“ DIN EN 60584	-50 ... +1768 °C	typ. 2K above 20 °C
Pt13Rh-Pt „R“ DIN EN 60584	-50 ... +1768 °C	typ. 2K above 50 °C
Shortest span	Type J, K, N: 50K Type S, R: 500K	
Cold junction	Pt100 internal or external cold junction (adjustable from 0 ... 80 °C)	
Cold junction accuracy	±1 K	
Sampling rate	>1 measurement per second	
Sensor current	350nA	
Input filter	1st order digital filter; filter constant adjustable: - on type 707014/... within the range 0 ... 125 s	
Features	also programmable in °F; freely programmable range limits; input isolated from output	

^a The accuracy refers to the maximum range span.

Input RTD temperature probe for the type 707014/...

Designation	Range limits	Range	Accuracy ^a
Pt100 DIN EN 60751	-200 ... +850 °C	-100 ... +200 °C -200 ... +850 °C	±0,2 K ±0,4 K
Pt100 JIS	-200 ... +649 °C	-100 ... +200 °C -200 ... +649 °C	±0,2 K ±0,4 K
Pt1000 DIN	-200 ... +250 °C	-100 ... +200 °C -200 ... +250 °C	±0,2 K ±0,4 K
Connection circuit	2-,3- or 4-wire circuit		
Shortest span	10K		
Sensor lead resistance - for 3-, 4-wire connection - for 2-wire connection	≤ 11 Ω per conductor measuring resistance + ≤22 Ω internal lead resistance		
Sensor current	< 0,6 mA		
Sampling rate	> 1 measurement per second		
Input filter	1st order digital filter; filter constant adjustable: - on type 707014/... within the range 0 ... 125 s		
Features	also programmable in °F; freely programmable range limits; input isolated from output		

^a The accuracy refers to the maximum range span.

Measurement circuit monitoring

Underrange	linear drop to 3.8 mA (as per NAMUR recommendation 43)
Overrange	linear rise to 20.5 mA (as per NAMUR recommendation 43)
Probe short circuit / probe and lead break	RTD temperature probe: ≤ 3.5 mA or ≥ 21.0 mA (configurable) thermocouple: ≤ 3.5 mA or ≥ 21.0 mA (configurable) ^a
Current limiting on probe short circuit or probe break	≤ 23 mA

^a Probe short-circuit recognition is not possible for thermocouple.

Output

	Types 707014/..., 707015/...	Types 707011/..., 707013/..., 707016/...
Output signal	proportional DC current 4 ... 20 mA, 20 ... 4 mA	
Electrical isolation Test voltage	between input and output Type 707014/...: $U_{peak} = 1.0 \text{ kV}/50 \text{ Hz}$ Type 707015/...: $U_{peak} = 3.75 \text{ kV}/50 \text{ Hz}$	between input and output $U = 2.0 \text{ kV}/50 \text{ Hz}$
Transfer characteristic	linear with temperature	
	Type 707015/...: customized linearization	customized linearization
	reversion of output signal	
Burden (Rb)	$Rb = (Ub - 8 \text{ V}) / 0.022 \text{ A}$	$Rb = (Ub - 10\text{V}) / 0.022\text{A}$
Burden error	$\leq \pm 0.02 \% / 100 \Omega^a$	
Calibration conditions / accuracy	24V DC at approx. 22 °C / $\leq \pm 0.05 \%^a$	
1st order digital filter	0 – 125 sec configurable	0 – 100 sec configurable
Step response 0 – 100 %	< 2 sec (with filter constant 0 sec)	
Switch-on delay (correct measurement after connecting the supply voltage only after ...)	5 sec	4 sec

^a All specified values refer to 20 mA full scale.

Custom linearization

Types 707011/..., 707013/..., 707016/... - Number of calibration points - Polynomial	maximum: 40 with linear interpolation 4th order polynomial
Type 707015/... - Number of calibration points	maximum: 40 with linear interpolation
Type 707014/...	No custom linearization available

Supply

Supply voltage (Ub) with reverse polarity protection	Type 707014/...: DC 8 ... 35V Type 707015/...: DC 8 ... 30V	Type 707011/...: DC 11,5 ... 35V Type 707013/...: DC 11,5 ... 35V Type 707016/...: DC 11,5 ... 30V
Supply voltage error	$\leq \pm 0,01 \% \text{ per V deviation from } 24 \text{ V}^a$	

^a All specified values refer to 20 mA full scale.

Environmental influences

Operating temperature range	-40 to +85 °C	
Storage temperature range	-40 to +100 °C	
Temperature error	RTD temperature probe: $\leq \pm 0.005 \% \text{ per } ^\circ\text{C deviation from } 22 \text{ }^\circ\text{C}^a$ thermocouple: $\leq \pm 0.005 \% \text{ per } ^\circ\text{C deviation from } 22 \text{ }^\circ\text{C}^a$ plus accuracy of cold junction	
Long-term stability	$\leq 0.1 \text{ }^\circ\text{C per year}^b$ or $\leq 0.05 \% \text{ per year}^{b,c}$	
Climatic conditions	rel. humidity $\leq 95 \%$, with condensation	
Vibration strength	according to GL characteristic 2	
Electromagnetic compatibility (EMC) - interference emission - immunity to interference	EN 61326-1 Class B to industrial requirements	
IP protection - in terminal head - open mounting - on rail	IP54 IP00 -	Types 707011/... and 707016/...: IP66 Types 707011/... and 707016/...: IP00 Type 707013/...: IP20

^a All specified values refer to 20 mA full scale

^b under calibration conditions

^c % refer to the selected span. The larger value applies.

Housing

	Types 707011/..., 707014/..., 707015/..., 707016/...	Type 707013/...
Material	polycarbonate (encapsulated)	polycarbonate
Screw terminal	≤ 1.75 mm ² ; max. tightening torque 0.6 Nm	≤ 2.5 mm ² ; max. tightening torque 0.6 Nm
Mounting	in terminal head Form B DIN 43729; in surface-mounting case (on request); in switchgear cabinet (mounting bracket is required)	on DIN rail 35mm x 7.5mm (EN 60715); on DIN rail 15mm (EN 60715); on G rail (EN 60715)
Operating position	unrestricted	
Weight	approx. 40g	approx. 90g



Version 707015/... (Ex) - Extract from the EC Type-Examination Certificate ZELM 99 ATEX 0018X

Marking	II 1 G Ex ia IIC T6–T4 Ga
Temp. range in "II 2 G" and "II 3 G"	T6 = -40 to +55 °C / T5 = -40 to +70 °C / T4 = -40 to +75 °C
Temp. range in "II 1 G"	T6 = -40 to +40 °C / T5 = -40 to +50 °C / T4 = -40 to +60 °C
Supply circuit Max. values at the terminals 1(+) and 2(-)	U _i = 30V DC I _i = 100 mA P _i = 750 mW
Internal inductance and capacitance	L _i = negligible C _i = negligible
Sensor circuit Max. values at the terminals 3, 4, 5 and 6	U _o = 9.6V DC I _o = 4.5 mA P _o = 11 mW linear output characteristic
Max. permissible external inductance and capacitance Ex ia IIC Ex ia IIB	L _o = 4.5 mH / C _o = 709 nF L _o = 8.5 mH / C _o = 1300 nF



Version 707016/... (Ex) - Extract from the EC Type-Examination Certificate PTB 01 ATEX 2124

Marking	II 1 G Ex ia IIC T6/T5/T4 II 2 G Ex ia IIC T6/T5/T4
Temp. range in "II 2 G" and "II 3 G"	T6 = -40 to +55 °C / T5 = -40 to +70 °C / T4 = -40 to +85 °C
Temp. range in "II 1 G"	T6 = -20 to +40 °C / T5 = -20 to +50 °C / T4 = -20 to +60 °C
Supply circuit Max. value at the terminals 1(+) and 2(-)	U _i = 30 VDC I _i = 100 mA P _i = 750 mW
Internal inductance and capacitance	L _i = negligible C _i = negligible
Sensor circuit Max. values at the terminals 3, 4, 5 and 6	U _o = 5 V DC I _o = 5.4 mA P _o = 6.6 mW linear characteristic
Internal inductance and capacitance	L _i = negligible C _i = negligible
Connected circuit without lumped external inductance or capacitance	L _o = 1000 mH C _o = 100 μF
Connected circuit with lumped external inductance or capacitance	
Ex ia IIC Ex ia IIB, Ex ia IIA	L _o = 100 mH / C _o = 2 μF L _o = 100 mH / C _o = 9.9 μF

Approvals/marks of conformity

Mark of conformity	Testing laboratory	Certificates/ certification numbers	Test basis	valid for
II 1 G Ex ia IIC T6-T4 Ga	ZELM Ex	ZELM 99 ATEX 0018 X	EN 60079-0:2012 + A11:2013 EN 60079-11:2012 EN 60079-26:2007 EN 1127-1:2011	Type 707015/...
Ex ia IIC T6...T4 Ga	ZELM Ex	IECEX ZLM 14.0011X	IEC 60079-0:2011 (ed. 6) IEC 60079-11:2011 (ed. 6) IEC 60079-26:2006	Type 707015/...
II 1 G Ex ia IIC T6/T5/T4 II 2 G Ex ia IIC T6/T5/T4	PTB	PTB 01 ATEX 2124	EN 60079-0:2012 + A11:2013 EN 60079-11:2012 EN 60079-26:2015	Type 707016/...

Setup program

The setup program is available for configuring the transmitter from a PC. With Types 707014/... and 707015/... , the connection is via the PC interface with a an USB/TTL converter and the setup interface of the transmitter, in the case of Types 707011/..., 707013/... and 707016/..., via a HART® modem. The connection for the setup circuit must only be used outside the hazardous area. It is not permissible to configure the transmitter inside the Ex area.

The protective cover must be closed after programming type 707015/... .

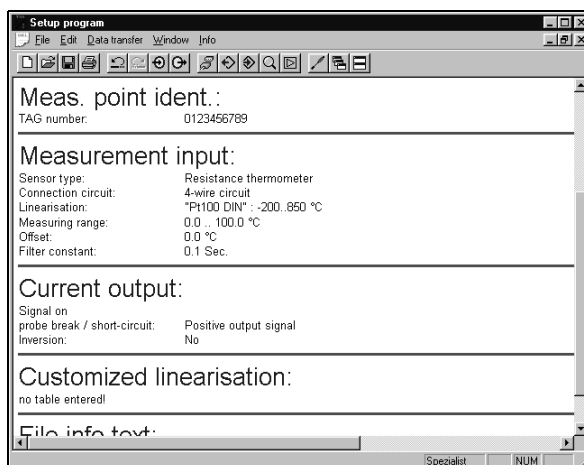

Configurable parameters

TAG number (10 characters) on Types 707011/..., 707013/... and 707016/..., 8 characters only, but with additional 16-character description	Sensor type
Connection circuit (2-/3-/4-wire)	External and internal cold junction
Customized linearization (not for type 707014/...)	Range limits
Output signal rising/falling (reversion)	Digital filter
Response to probe break/short circuit	Recalibration/fine calibration (not for Types 707011/..., 707013/... and 707016/...)
Lead resistance with 2-wire circuit	

If no power supply (supply isolator) is available, the 2-wire transmitter Type 707014/... or 707015/... has to be configured using a 9V block battery as a power source.

Fine calibration (not on Types 707011/..., 707013/... and 707016/...)

Fine calibration means correction of the output signal. The signal can be adjusted within ± 5 % of the 20 mA full-scale value. Fine calibration is performed through the setup program. Values for 4 mA (zero), 20 mA (full scale) and offset can be calibrated separately, via the setup program.

Hardware and software requirements

A PC with CD/DVD drive as well as a serial interface or USB interface (e.g. HART® modem) is required to install and use the setup program.

Details about supported operating systems (Microsoft® Windows®), required hard disk drives, and memory can be found under information about the setup program on the manufacturer's website (search for 707010, in the search results click the link to the product, go to software, and look for further information about the setup program).

Setup interface (Types 707014/... and 707015/...)

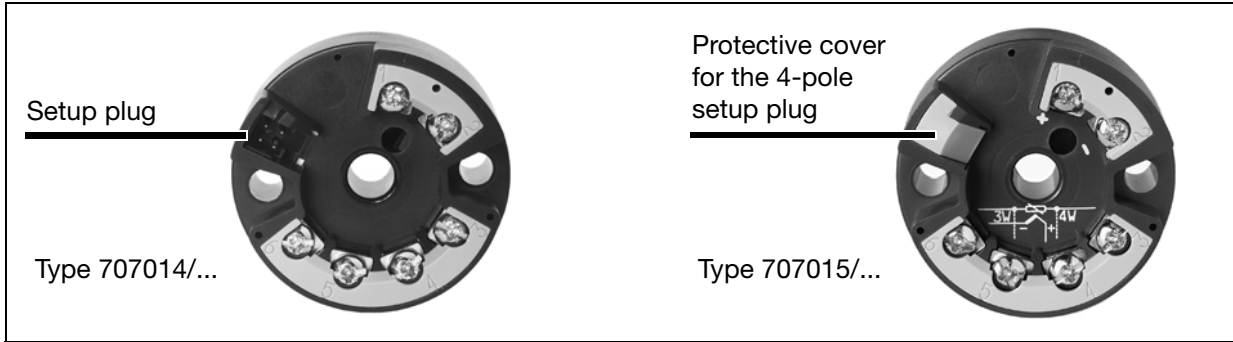

HART[®] interface (Type 707011/... and 707013/...)

Connection via HART[®] modem

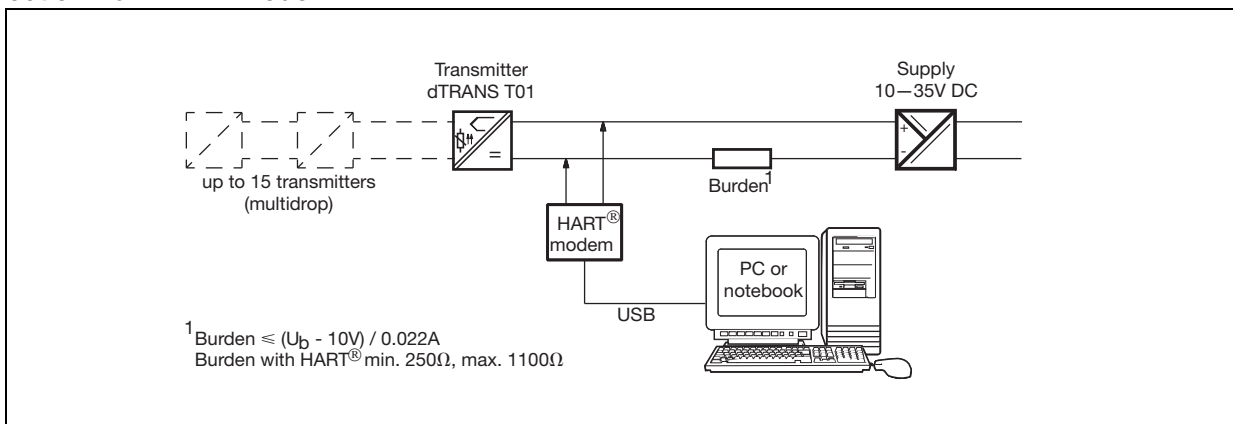

HART[®] interface (Type 707016/...)

Connection via HART[®] modem for Ex application

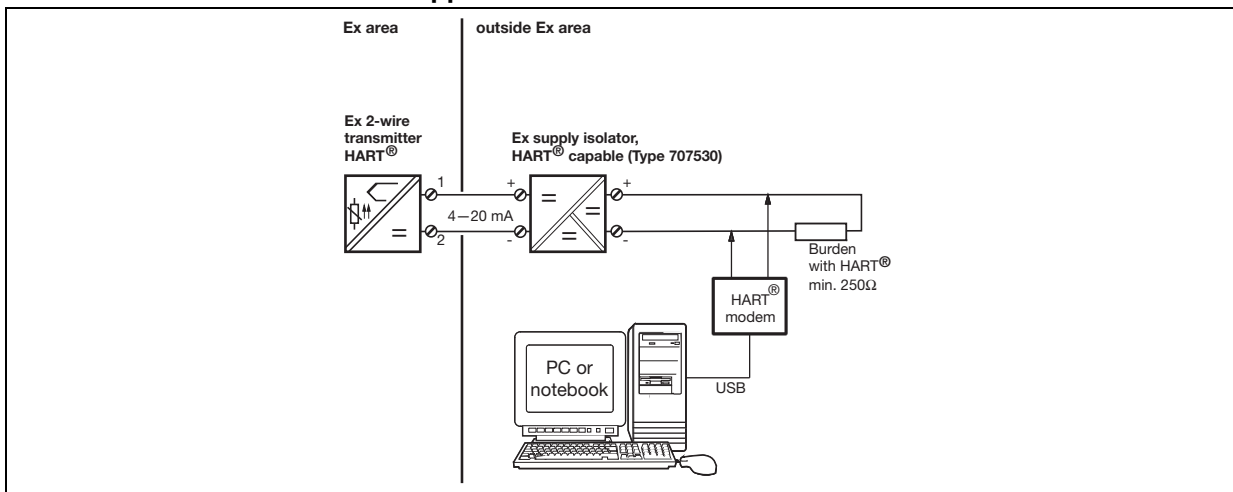

Connection diagram

<p>21^{+0.5}₀</p> <p>Ø44⁺¹₀</p> <p>33</p> <p>Type 707011/..., Type 707015/..., Type 707016/...</p> <p>Setup</p> <p>33</p> <p>Type 707014/...</p>	Connection for		Terminals		
		Supply voltage for Type 707011/... 11,5 ... 35V DC	+1	$R_B = \frac{U_b - 11,5V}{22mA}$	
		Supply voltage for Type 707014/... 8 ... 35V DC	-2	$R_B = \frac{U_b - 8V}{22mA}$	
		Supply voltage for Type 707015/... 8 ... 30V DC (Ex) ^a		$R_B = \frac{U_b - 8V}{22mA}$	
	Supply voltage for Type 707016/... 11,5 ... 30V DC (Ex) ^a		$R_B = \frac{U_b - 11,5V}{22mA}$		
	Current output 4 – 20 mA			$R_B = \text{burden resistance}$ $U_b = \text{supply voltage}$	
Ex version only in conjunction with certified Ex transmitter supply unit					
Analog inputs					
	Thermocouple	+4 -6			
	RTD temperature probe in 2-wire circuit	3 6	$R_L \leq 11 \Omega$ $R_L = \text{lead resistance per conductor}$		
	RTD temperature probe in 3-wire circuit	3 5 6	$R_L \leq 11 \Omega$ $R_L = \text{lead resistance per conductor}$		
	RTD temperature probe in 4-wire circuit	3 4 5 6	$R_L \leq 11 \Omega$ $R_L = \text{lead resistance per conductor}$		
Ex version: please note connection data of the Ex input circuit!					

^a On types 707015/... and 707016/... only up to 30V. The connection must only be made to an intrinsically safe circuit.



<p>61</p> <p>22.5</p> <p>Depth behind panel 98 max.</p> <p>11 12 13</p> <p>⊖ 11/12/13/14 Sensor</p> <p>JUMO dTRANS T01 T</p> <p>⊕ 81/82 4...20mA</p> <p>+81 -82 14</p>	Connection for		Terminals		
		Supply voltage for Type 707013/... 11,5 – 35 V DC	+81	$R_B = \frac{U_b - 11,5V}{22mA}$	
		Current output 4 – 20 mA	-82	$R_B = \text{burden resistance}$ $U_b = \text{supply voltage}$	
	Analog inputs				
	Thermocouple (special feature: see order details)	+11 -12			
	RTD temperature probe in 2-wire circuit	11 13	$R_L \leq 11 \Omega$ $R_L = \text{lead resistance per conductor}$		
	RTD temperature probe in 3-wire circuit	11 12 13	$R_L \leq 11 \Omega$ $R_L = \text{lead resistance per conductor}$		
	RTD temperature probe in 4-wire circuit	11 12 13 14	$R_L \leq 11 \Omega$ $R_L = \text{lead resistance per conductor}$		

Caution: the order details on P. 9 must be observed

Order details: JUMO dTRANS T01 / T01T

Programmable 2-wire transmitter

(1) Basic type

	707011	dTRANS T01 B HART® programmable 2-wire transmitter with HART® interface	
	707013	dTRANS T01 T HART programmable 2-wire transmitter with HART interface installed in rail mounting housing ^a (Caution: observe the footnotes)	
	707014	dTRANS T01 Junior	
	707015	dTRANS T01 B Ex programmable 2-wire transmitter with Ex protection	 
	707016	dTRANS T01 B Ex HART® programmable 2-wire transmitter with HART® interface and Ex protection	
	(2) Input (programmable)		
x x x x x	888	factory-set (Pt100 DIN 4w / 0 ... 100 °C)	
x x x x x	999	configuration to customer specification ^b	
	(3) Output (proportional DC current)		
x x x x x	888	factory-set (4 – 20 mA)	
x x x x x	999	configuration to customer specification (20 ... 4 mA)	
	(4) Probe break/ short circuit		
x x x x x	888	factory-set (positive protection)	
x x x x x	999	configuration to customer specification (negative protection)	
	(5) Extra codes		
x x x x x	000	none	
x x x x x	243	transmitter in surface-mounting case	

Order code

(1) / (2) - (3) - (4) / (5)

Order example

707010 / 888 - 888 - 888 / 243

^a When ordering, please specify the type of sensor required (thermocouple or RTD temperature probe). For thermocouple inputs, the sensor input cannot be changed retrospectively, because of the internal compensating cable. For RTD temperature probe inputs, all types of RTD temperature probes listed on P. 2 can be connected, but no thermocouples. Thermocouple inputs are available on request.

^b Probe type and range have to be specified in plain text for configuration to customer specification.

Standard accessories

- 1 Operating Instructions
- Fixing items: 2 screws, 2 compression springs (not for Type 707013/...)

Accessories

- PC setup program, multilingual
- PC interface with USB/TTL converter, adapter (socket) and adapter (pins) for Types 707014/... and 707015/...
- Bracket for mounting on DIN rail, part no. 00352463
- HART® modem USB (for Types 707011/..., 707013/... and 707016/...), part no. 00443447
- Power supply units 1- and 4-way (Data Sheet 707500)
- Ex-i power supply/input isolating amplifier (Data Sheet 707530), part no. 00577948