

LS2LR30-1500Q8

Light Screen for Machine Safety Applications – Receiver

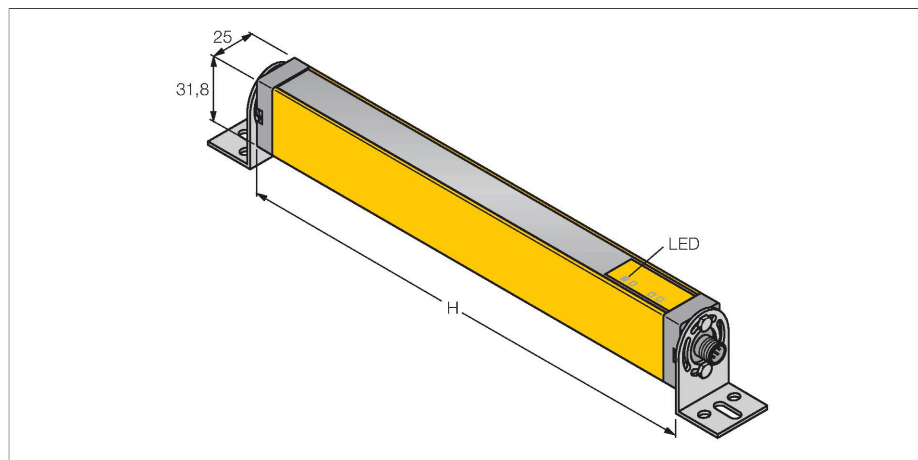

Features

- Male M12 × 1, 8-pin
- Protection class IP65
- Scan field 1500 mm
- Resolution 30 mm
- Internal testing in 500 ms cycle
- Range 15 m
- Operating voltage 24 VDC +15 %
- Switching output with LATCH
- Muting is not supported
- Type 2 acc. to IEC 61496-1,-2; category 2
PLd acc. to EN ISO 13849-1; SIL2 acc. to IEC 61508

Technical data

Type	LS2LR30-1500Q8
ID	3073563
Optical data	
Function	Light screen
Optical resolution	30 mm
Range	200...15000 mm
Scan field	1500 mm
Number of beams	80
With muting function	no
Scan Code	None
Electrical data	
Operating voltage	20...28 VDC
Residual ripple	< 15 % U _{ss}
DC rated operational current	≤ 90 mA
No-load current	≤ 90 mA
Max. current safe output	500 mA
Output function	2 x NC (normally closed), 2 x PNP
Current output	500 mA
Number of safe semiconductor outputs	2
Response time typical	< 25 ms
With restart interlock	yes
Blanking function	no
Mechanical data	
Design	Rectangular, EZ-Screen
Dimensions	31.8 x 25.2 x 1563 mm
Housing material	Metal, AL, Yellow polyester
Lens	plastic, Acrylic

Wiring diagram

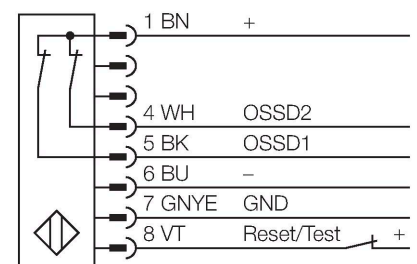

Functional principle

The safety light curtain consists of an emitter and a receiver. The system is optically synchronized, making the wiring between emitter and receiver redundant. The receiver's safety switching outputs are directly connected to a load relay and trigger an immediate stop of the dangerous machine cycle. Due to the dual-channel design of the switching device, personal safety degree type 2 acc. to IEC 61496 and category 2 acc. to EN 9541 are fulfilled.

Technical data

Cascadable	No
Electrical connection	Connector, M12 × 1
Number of cores	8
Ambient temperature	0...+55 °C
Protection class	IP65
Power-on indication	LED, Green
Switching state	LED, Red
Tests/approvals	
Vibration resistance	10-55 Hz at 0.35 mm
Shock test	10 g at 16 ms (6000 cycles)
Approvals	CE, cULus listed