



IPAQ-H / IPAQ-HX

Universal Intelligent 2-wire In-head Transmitters

Actual size

IPAQ-H is a universal and intelligent 2-wire In-head transmitter for temperature and other measurement applications.

IPAQ-HX is the Intrinsic Safe version for use in Ex-applications.

The combination of *competitive pricing, functionality and simple configuration* has made IPAQ-H and IPAQ-HX leading in-head transmitters for industrial temperature measurements.



The Windows based and user friendly software, IPRO 4, is used for transmitter configuration, documentation, monitoring and calibration purposes.

Performance and design:

Excellent stability

- Long-term stability 0.1 %/year.

Enhanced total system accuracy

- Sensor error correction (for known sensor errors).
- System error correction (against known temperatures).

NAMUR-compliant

- Output limitations and fail currents according to NAMUR recommendations.

Input-Output isolation 1500 VAC

- Eliminates measuring errors due to ground loops.

High load capacity

- Only 6.5 V voltage drop over the transmitter (IPAQ-H) allows for high loads.

Designed for harsh conditions

- Operation temperature: -40 to +85 °C, -40 to +185 °F.
- Excellent EMC performance.
- Durable, shockproof design.

Simple mounting and connection

- For DIN B head or larger.
- Large center hole (dia. 7 mm / 0.28 inch).

5 year limited warranty

Functions:

Input for RTDs, T/Cs, mV and resistance

- Reduced inventory costs.
- Simplified plant engineering.

True on-line communication

- Full access to all features while in operation.

Sensor diagnostics

- SmartSense detects low sensor isolation (essential for correct measurements).
- Selectable sensor break action.

Simplified loop check-up

- The transmitter works as an accurate current generator.

On-screen indications and line recording

- Valuable tools for temporary measurements.

Main features of IPAQ-H and IPAQ-HX

Accuracy and stability

IPAQ-H/IPAQ-HX are designed for applications with standard industrial demands on accuracy. To reach these demands, the following factors are essential:

Linearity and calibration errors -The use of quality components and precision calibration equipment reduce these errors, e.g. $\pm 0.1\%$ of span for RTD inputs.

High long-term stability -Internal "self calibration", by means of continuous adjustment of important parameters after comparison with accurate built-in references, contributes to a stability of $\pm 0.1\%$ /year.

Measurements with RTDs and other resistances

IPAQ-H/IPAQ-HX accept inputs from standardized Platinum and Nickel RTDs like Pt10...Pt1000 acc. to IEC 751 ($\alpha=0.00385$), Pt100 acc. to JIS 1604 ($\alpha=0.003916$) and Ni100/Ni1000 acc. to DIN 43760, as well as inputs from plain resistance sensors such as potentiometers. 3- or 4-wire connection can be chosen.

Measurements with thermocouples and plain voltage

IPAQ-H/IPAQ-HX accept inputs from 11 types of standardized thermocouples as well as plain mV input.

For T/C input, the CJC (cold junction compensation) is fully automatic, by means of an accurate measurement of the terminal temperature. Alternatively, the CJC can be disabled.

Customized linearization and Engineering units

The *Customized linearization* can be used to create a linearization curve for RTD, T/C, resistance and mV inputs. By combining *Customized linearization* with the use of *Engineering units*, the transmitters can be programmed to give a linear output corresponding to a specific measuring range expressed in the primary process value. The sensor characteristics are described by a maximum of 9 data pairs. Fig. 1a and 1b.

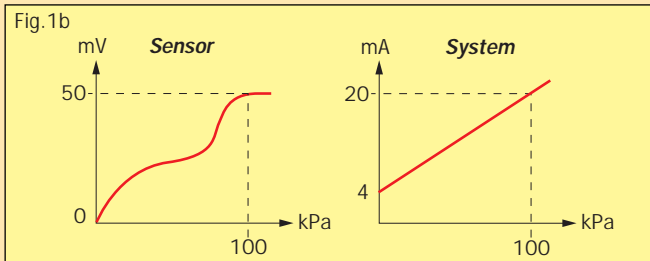
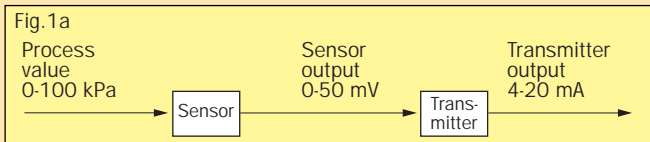

Example of a system (sensor + transmitter) with an output **linear** to the process value, in spite of a **non-linear** sensor.

Sensor or System error correction

IPAQ-H/IPAQ-HX offer two ways of improving the measurement with temperature sensors:

Sensor error correction - Known sensor errors compared to the standard curve, e.g. for a calibrated sensor, are entered, and the transmitter automatically corrects for the sensor errors. Fig. 2.

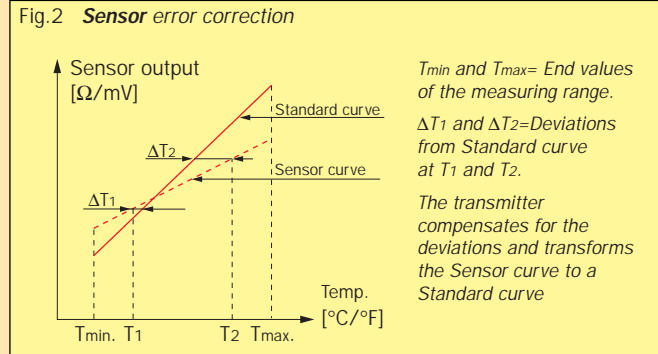

System error correction -This method is used to correct the system error (sensor + transmitter error) by exposing the sensor to one (one-point correction) or two (two-point correction) accurately measured temperatures (true temperatures). The true temperature(s) are entered, and the transmitter automatically corrects for the system errors. Fig. 3.

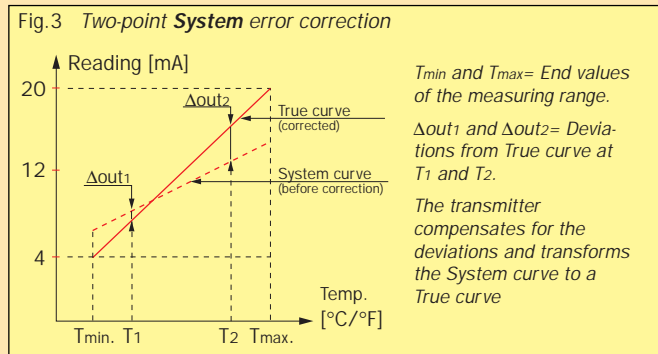

SmartSense - Sensor isolation monitoring

SmartSense continuously monitors the isolation resistance of thermocouples and 3-wire connected RTDs as well as the cabling between sensor and transmitter. The transmitter will react by forcing the output to a user defined level if the isolation is too low. SmartSense requires an extra lead inside the thermocouple or RTD. Fig. 5.

For detailed information, see section Theory and Facts.

Sensor break monitoring

IPAQ-H/IPAQ-HX monitor sensor break and force the output signal to a user defined level, when *any* sensor lead is broken or disconnected. The sensor break monitoring can be switched off. The monitoring is furnished with a *pulsed excitation current*. This eliminates the voltage drop in the lead wires (giving a measuring error), caused by a standard DC excitation current.

Controlled output for instrument calibration

IPAQ-H/IPAQ-HX can be set to automatically provide a recurring output current regardless of the input signal. The total time for the controlled output is adjustable up to 30 minutes.

Dampening

The dampening function can be used to dampen undesired instabilities on the input signal. The dampening time is approximately 2 seconds. The dampening time, is the time required, in addition to the update time, for the output to reach 90% of its final value after a step change has been applied to the input.

Power supply

IPAQ-H/IPAQ-HX are loop-powered and will work on voltages down to 6.5 VDC (8 VDC for IPAQ-HX), thus giving good margins for high loads in the current loop. Reversed polarity will not damage the transmitter. Fig. 6

Mounting

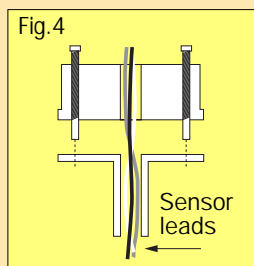

IPAQ-H/IPAQ-HX are designed to fit inside connection heads type DIN B or larger.

The large center hole, dia. 7 mm / 0.28 inch, facilitates the pulling through of the sensor leads or an insert tube, greatly simplifying the mounting procedure. Fig. 4.

Warranty

IPAQ-H/IPAQ-HX are covered by a 5 year limited warranty.

IPRO 4 - The user friendly software for all transmitters of the IPAQ family

IPRO 4, which is used with all IPAQ-transmitters, is the tool to utilize all the versatile functions of the IPAQ-H/IPAQ-HX such as:

- Measurement configuration: Sensor type, range, sensor or system error correction, linearization, engineering units, output settings, filter activation, etc.
- Monitoring of sensor status: Sensor break and sensor isolation (SmartSense).
- On-screen real time presentation of measured values and output signal in the form of numericals, meters, bar graphs and line recorder.
- Transmitter calibration: Field calibration in one or two points and basic calibration.
- Documentation: Configuration files can be saved for future use and configuration protocols can easily be printed.

The communication with the transmitter can be performed on line, i.e. with transmitter in operation. An isolated and Ex-approved communication cable is included in the software kit, IPRO-X.

IPRO 4 is compatible with Windows 3.1, Windows 3.11, Windows 95 and Windows NT Workstation 4.0. The program is menu-driven and easy to learn. On-line help is an effective tool for the user.

IPAQ-H/IPAQ-HX Configuration scheme

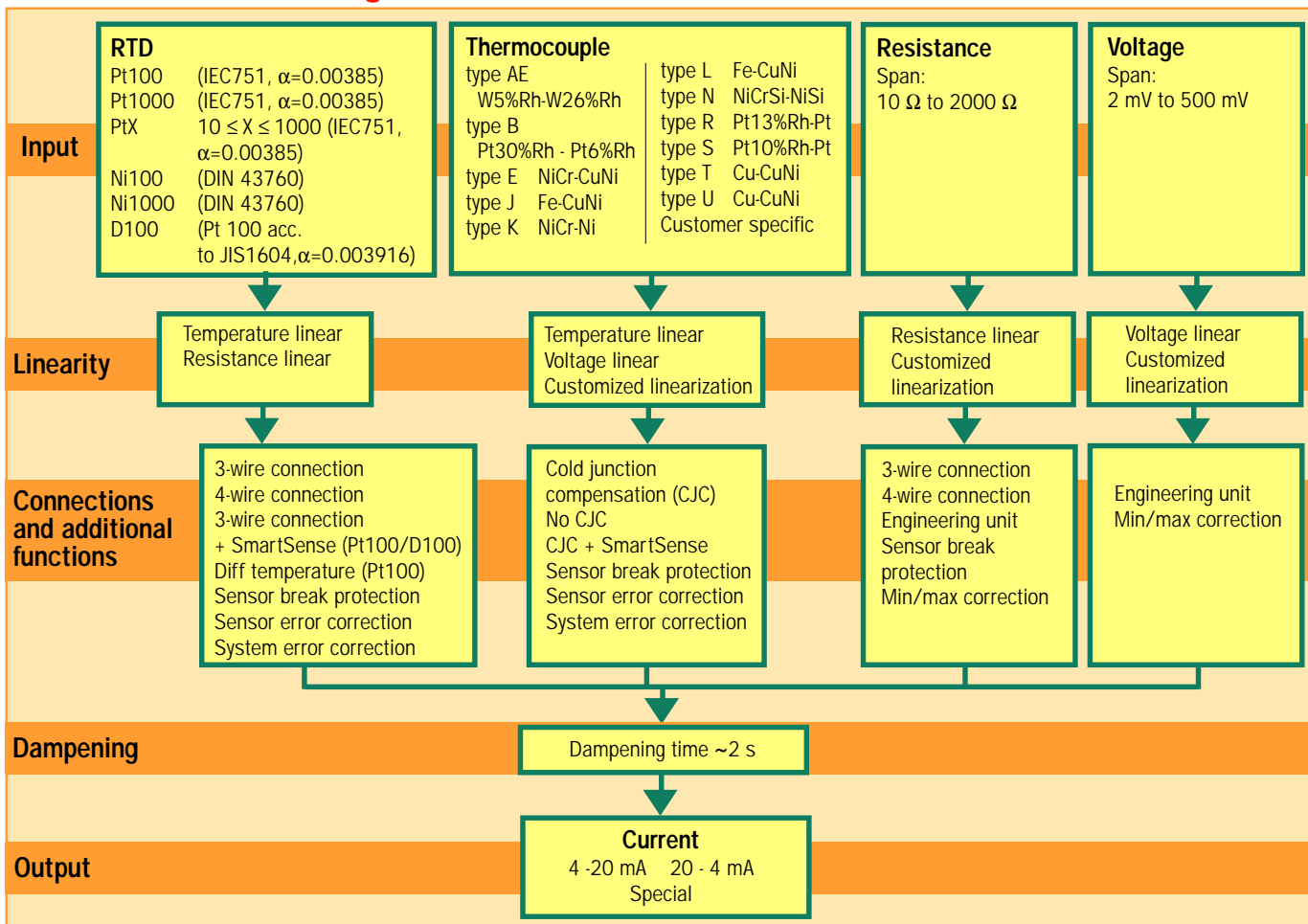

Specifications

| Input | | |
|---|--|-------------------------------------|
| RTD's and Resistance | | |
| Pt100 (IEC751, $\alpha = 0.00385$) | 3-, 4-wire connection | -200 to +1000 °C / -328 to +1832 °F |
| Pt1000 (IEC751, $\alpha = 0.00385$) | 3-, 4-wire connection | -200 to +200 °C / -328 to +392 °F |
| PtX $10 \leq X \leq 1000$ (IEC751, $\alpha = 0.00385$) | 3-, 4-wire connection | Upper range depending on X-value |
| Ni100 (DIN 43760) | 3-, 4-wire connection | -60 to +250 °C / -76 to +482 °F |
| Ni1000 (DIN 43760) | 3-, 4-wire connection | -60 to +150 °C / -76 to +302 °F |
| D100 (Pt 100 acc.to JIS1604, $\alpha = 0.003916$) | 3-, 4-wire connection | -200 to +1000 °C / -328 to +1832 °F |
| Potentiometer/resistance | 3-, 4-wire connection | 0 to 2000 Ω |
| Sensor current | | ~ 0.4 mA |
| Maximum sensor wire resistance | | 25 Ω /wire |
| Thermocouples and Voltage | | |
| T/C | Type: AE, B, E, J, K, L, N, R, S, T, U | Ranges according to users manual |
| Voltage input | | -10 to +500 mV |
| Input impedance | | >10 M Ω |
| Maximum sensor wire resistance | | 500 Ω (total loop) |
| Monitoring | | |
| Sensor break monitoring | User definable output | 3.5 to 21.6 mA |
| SmartSense, sensor isolation monitoring | User definable output | 3.5 to 21.6 mA |
| Adjustments | | |
| Zero adjustment | All inputs | Any value within range limits |
| Minimum spans | Pt100, Pt1000, Ni100, Ni1000 | 10 °C / 18 °F |
| | Potentiometer | 10 Ω |
| | T/C, mV | 2 mV |
| Output | | |
| Straight, reversed or any intermediate value | | 4-20/20-4 mA |
| Resolution | | 5 μ A |
| Minimum output signal | Measurement/Failure | 3.8 mA / 3.5 mA |
| Maximum output signal | Measurement/Failure | 20.5 mA / 21.6 mA |
| Permissible load, see fig.6 | IPAQ-H | 795 Ω @ 24 VDC, 22 mA |
| | IPAQ-HX | 725 Ω @ 24 VDC, 22 mA |
| Temperature | | |
| Ambient, storage | | -40 to +85 °C / -40 to +185 °F |
| Ambient, operation | IPAQ-H | -40 to +85 °C / -40 to +185 °F |
| | IPAQ-HX | See Intrinsic Safety specifications |
| General data | | |
| Selectable dampening time | | ~ 2 s |
| Update time | | ~ 1.5 s |
| Isolation In - Out | Isolated version | 1500 VAC, 1 min |
| Humidity (non-condensing) | | 0 to 95 %RH |
| Intrinsic safety | IPAQ-HX, ATEX | II 1 G EEx ia IIC T4, T5, T6 |
| | FM | Class I, Div. 1, Group A-D, T4 |
| Power supply, polarity protected | | |
| Supply voltage | IPAQ-H | 6.5 to 36 VDC 2-wire |
| | IPAQ-HX | 8.0 to 30 VDC 2-wire |
| Permissible ripple | | 4 V p-p @ 50/60 Hz |

| Accuracy | | |
|--|----------------------------|---|
| Linearity | RTD Potentiometer, mV | ±0.1 % ¹⁾ |
| | T/C | ±0.2 % ¹⁾ |
| Calibration | RTD | Max. of ±0.2 °C / ±0.4 °F or ±0.1 % ¹⁾ |
| | Potentiometer | Max. of ±0.1 Ω or ±0.1 % ¹⁾ |
| | mV, T/C | Max. of ±20 μV or ±0.1 % ¹⁾ |
| Cold Junction Compensation (CJC) | T/C | ±0.5 °C / ±0.9 °F |
| Temperature influence ⁴⁾ | All inputs | Max. of ±0.25 °C/25 °C or ±0.25%/25 °C ^{1) 3)} |
| | | Max. of ±0.5 °F/50 °F or ±0.28%/50 °F ^{1) 3)} |
| Temperature influence CJC ⁴⁾ | T/C | ±0.5 °C/25 °C / ±1.0 °F/50 °F |
| Instrument calibration output | 4-20 mA | ±8 μA |
| Sensor wire resistance influence | RTD, Potentiometer, 3-wire | Negligible ²⁾ |
| | RTD, Potentiometer, 4-wire | Negligible |
| | mV, T/C | Negligible |
| Load influence | | Negligible |
| Power supply influence | | Negligible |
| RFI influence, 0.15 to 1000 MHz, 10 V or V/m | | ±0.1% ¹⁾ (typical) |
| Long-term stability | | ±0.1 % ¹⁾ /year |
| Housing | | |
| Material / Flammability (UL) | | PC + ABS/V0, Polyamide/V2 |
| Mounting | | DIN B-head or larger, DIN rail (with mounting kit) |
| Connection | Single/stranded wires | ≤1.5 mm ² , AWG 16 |
| Weight | | 50 g |
| Protection, housing / terminals | | IP 50 / IP 10 |

¹⁾ Of input span

²⁾ With equal wire resistance

³⁾ If zero-deflection > 100% of input span:
add 0.125% of input span/25 °C or 0.14%
of input span/50 °F per 100% zero-deflection

⁴⁾ Reference temperature 23 °C / 73°F

The User Instructions must be read prior to adjustment and/or installation.

Intrinsic Safety specifications

| Specifications | IPAQ-HX, isolated | IPAQ-HX, isolated |
|------------------------------|---|---|
| Approval | Demko / ATEX | Factory Mutual (FM) |
| Classification | II 1 G EEx ia IIC T4-T6 T4/+85°C, T5/+65°C, T6/+50°C | IS for use in Class I, Div. 1, Group A-D, T4/+80°C |
| Certificate No. | DEMKO 02 ATEX 132033 | J.I. 0D6A8.AX, Drw. 3-7851 |
| Output/Supply | | |
| Max voltage to transmitter | U _i = 30 Vdc | V _{max} = 30 Vdc |
| Max current to transmitter | I _i = 100 mA | I _{max} = 100 mA |
| Max power to transmitter | P _i = 900 mW | P _{max} = 900 mW |
| Internal inductance | L _i = 0 mH | L _i = 2.5 mH |
| Internal capacitance | C _i = 0 μF | C _i = 0 μF |
| Input (Sensor) | | |
| Max voltage from transmitter | U _o = 30 Vdc | V _{oc} = 30 Vdc |
| Max current from transmitter | I _o = 25 mA | I _{sc} = 25 mA |
| Max power from transmitter | P _o = 188 mW | Not specified |
| Max inductance (input loop) | L _o = 50 mH | L _a = 56.8 mH |
| Max capacitance (input loop) | C _o = 66 nF | C _a = 0.12 μF |

INPUTS

RTD

Pt100, Pt1000, Ni100, Ni1000, PtX, D100
4-wire connection

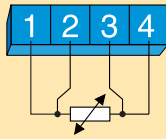

3-wire connection

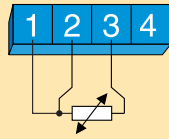

Pt100, D100
3-wire connection

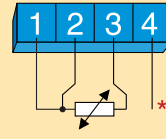

* SmartSense lead

Pt100
Diff temperature $T_1 > T_2$

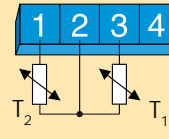

Potentiometer

4-wire connection

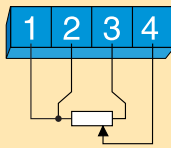

3-wire connection

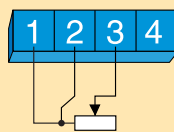

Voltage

millivolt

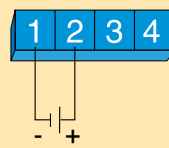

Thermocouple

AE, B, E, J, K, L, N, R, S, T, U
or customer specific

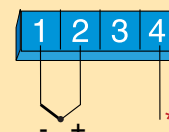

* SmartSense lead

OUTPUT

4-20 mA Output

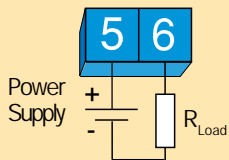

Connections

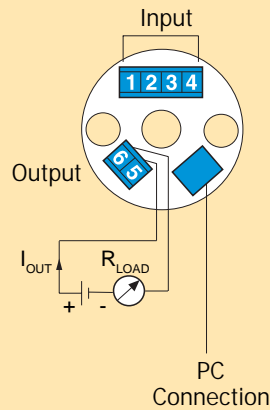

Dimensions

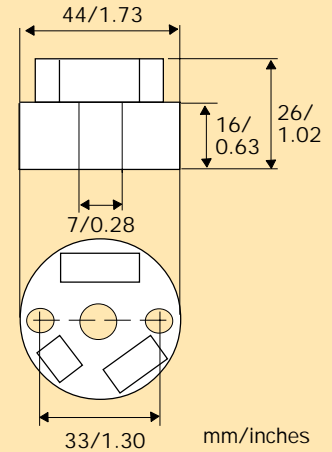

SmartSense

Fig.5

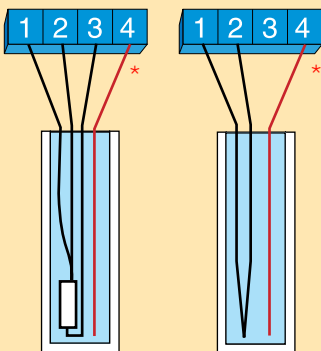

Pt100/D100 T/C

* SmartSense lead

Output load diagram

Fig.6

Permissible R_{Load} at 22 mA output

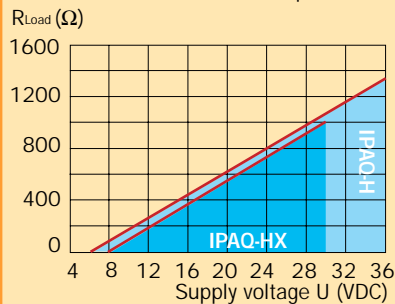

$$R_{Load} = (U - 6.5) / 0.022 \quad (\text{IPAQ-H})$$

$$R_{Load} = (U - 8) / 0.022 \quad (\text{IPAQ-HX})$$

Ordering table

| Item | Part No. |
|--|-----------------------|
| Transmitter | |
| IPAQ-H, isolated | 70IPH00001 |
| IPAQ-H, non-isolated | 70IPH00002 |
| IPAQ-HX, isolated (ATEX) | 70IPHX0001 |
| IPAQ-HX, non-isolated (Genelec) | 70IPHX0002 |
| IPAQ-HX, isolated (FM) | 70IPHX1001 |
| Options | |
| Configuration | 70CAL00001 |
| Configuration with 5-point calibration certificate | 70CAL00051 |
| Software and cable | |
| PC Configuration kit | 70CFG00092 |
| Software IPRO upgrade | 70IPRS0001 |
| Accessories | |
| Surface mounting box | 70ADA00008 |
| Rail mounting box | 70ADA00009 |
| Head mounting kit | 70ADA00012 |
| Rail mounting kit | 70ADA00013 |