

VALVE BODY W9 TYPE T

ART. NO. 850001

GENERAL

- The KEOFIT CLASSIC W9 Sampling Valve is the original and leading sterilizable sampling valve in the world. Used in all industries for decades. + 320 standard valve configurations. Unique serial no. for each valve ("E" = internal electro polish).
- Valve body designed for sampling of liquids with a viscosity of up to approx. 1.000 cP containing no particles larger than Ø3 mm. Sampling of more viscous liquids is possible, only will it take longer (depending on process pressure).
- Cleaning/sterilizing: Between batches: Valve in open position: Cleanable by means of CIP using the detergent solution suitable for the actual process media (EHEDG certificate available). Between samples: Valve in its normal closed position: cleanable by CIP as "Between batches" or the valve may be sterilized by means of steam SIP (EHEDG test report available) or chemical SIP using a procedure appropriate to the actual circumstances. For further advice, please contact Keofitt.
- The sampling valve can be used for any process sampling for microbiological, chemical and/or physical analysis.

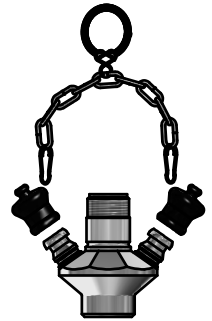

FEATURES

- Installation: Tank welding
- Operation: Depending on choice of valve head
- Inlet / Outlet: Hose piece
- Membrane: Depending on choice of valve head

CERTIFICATION*

· EHEDG CIP · Conforms to 3-A · 3.1 Material Certificate · EU 1935/2004 · Ra Cert. incl. measurements

TECHNICAL DATA

Material (product contact)

· Steel parts AISI 316L (1.4404)

Material (without product contact)

· Steel parts AISI 316L (1.4404)
 · Rubber cap EPDM (black)
 · Stainless steel chain Stainless steel

Surface Treatment

· Outside Electropolished Ra <= 1.2 µm
 · Inside (wetted surface) Electropolished Ra <= 0.5 µm
 · Process connection Electropolished Ra <= 0.5 µm

Pressure & Temperature

· Pressure Depending on choice of valve head
 · Temperature Depending on choice of valve head
 · Air supply Depending on choice of valve head

Net Weight







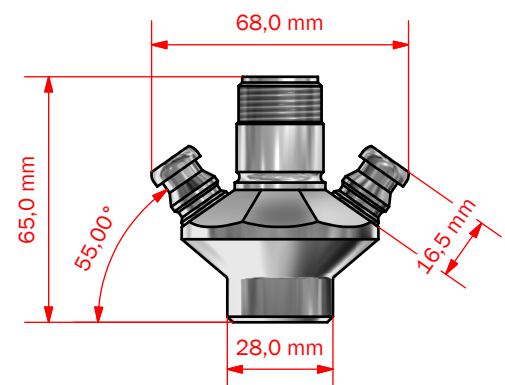
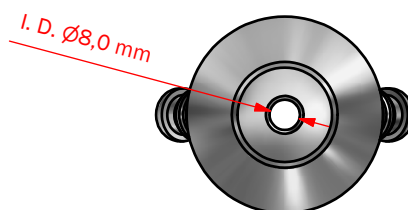
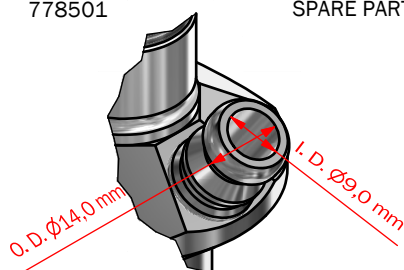
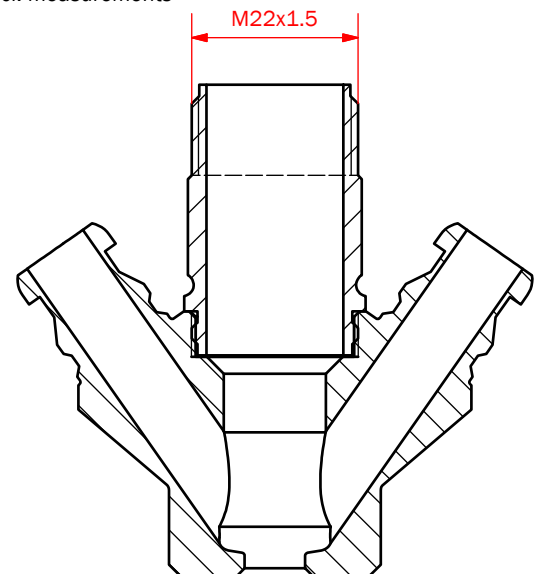















· Kg/lbs 0.317 kg /0,69 lbs

Spareparts

778501 SPARE PARTS FOR W9 850001/03/11/14/21/36



W 9 HEADS

	Type H Turn knob		600041		600041E		855541
	Type H Turn knob with Microport option		600048		600048E	<i>Not available</i>	
	Type K Key ring		600042		600042E		855542
	Type K Key ring with Microport option		600049		600049E	<i>Not available</i>	
	Key Ring for valve head		600076		600076		600076
	Type Q Lever handle		600043		600043E		855543
	Type N Lever handle Pneumatic		600044		600044E		855544
	Type B No spring 0-1.2 bar(g)		600047		600047E		855547
Silicone							
EPDM							
PTFE							