

EVW093

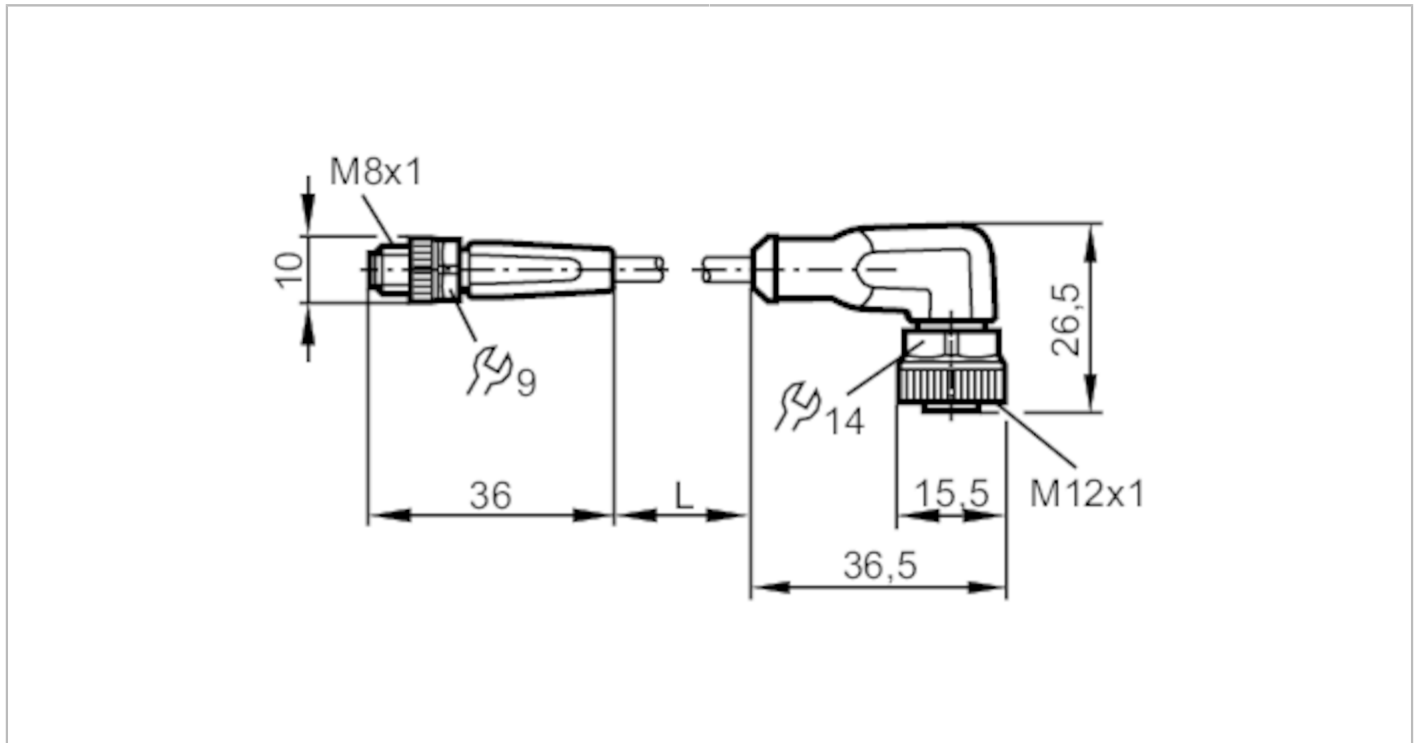

Connection cable

VDOAH030SCS01,5T03STGF030SCS



Application	
System	Free from silicone; Halogen-free; gold-plated contacts; Drag chain suitability
Application	welding applications
Free from silicone	yes
Electrical data	
Operating voltage [V]	< 50 AC / < 60 DC
Protection class	III
Max. current load total [A]	3
Operating conditions	
Ambient temperature [°C]	-25...90
Note on ambient temperature	cULus: ...75
Ambient temperature (moving) [°C]	-25...90
Note on ambient temperature (moving)	cULus: ...75
Protection	IP 65; IP 67; IP 68; IP 69K

EVW093



Connection cable

VDOAH030SCS01,5T03STGF030SCS

Mechanical data		
Weight [g]	64.7	
Dimensions [mm]	10 x 10 x 36	
Material	housing: TPU (urethane) orange; sealing: FKM	
Material nut	brass, weld coated	
Drag chain suitability	yes	
Drag chain suitability	Bending radius for flexible applications	min. 10 x cable diameter
	Travel speed	max. 3.3 m/s for a horizontal travel length of 5 m and max. acceleration of 5 m/s ²
	Bending cycles	> 2 Mio.
	Torsional strain	± 180 °/m

Remarks	
Remarks	without label holders
Pack quantity	1 pcs.

Electrical connection - plug

Connector: 1 x M8, straight; coding: A; Locking: brass, weld coated; Contacts: gold-plated; Tightening torque: 0.3...0.5 Nm

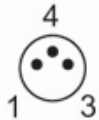

Electrical connection

Cable: 1.5 m, PUR, Halogen-free, grey, Ø 4.5 mm; not irradiated (can be recycled); resistant to welding sparks; 3 x 0.25 mm² (32 x Ø 0.1 mm)

Connection

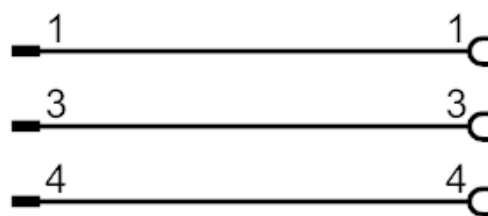

Electrical connection - Socket

Connector: 1 x M12, angled; coding: A; Locking: brass, weld coated; Contacts: gold-plated; Tightening torque: 0.6...1.5 Nm

EVW093



Connection cable

VDOAH030SCS01,5T03STGF030SCS

