

CS210

Kiln Shell Temperature Monitoring System



 **Raytek**[®]
A Fluke Company

Rev. B2 10/2012
58401

CONTACTS

Raytek Corporation

Worldwide Headquarters

Santa Cruz, CA USA

Tel: +1 800 227 – 8074 (USA and Canada only)

+1 831 458 – 3900

Fax: +1 831 458 – 1239

solutions@raytek.com

European Headquarters

Berlin, Germany

Tel: +49 30 4 78 00 80

raytek@raytek.de

France

info@raytek.fr

United Kingdom

ukinfo@raytek.com

Fluke Service Center

Beijing, China

Tel: +86 10 6438 4691

info@raytek.com.cn

Internet: <http://www.raytek.com/>

Thank you for purchasing this Raytek product. Register today at www.raytek.com/register to receive the latest updates, enhancements and software upgrades!

© Raytek Corporation.

Raytek and the Raytek Logo are registered trademarks of Raytek Corporation.

All rights reserved. Specifications subject to change without notice.

WARRANTY

Raytek warrants this product to be free from defects in material and workmanship under normal use and service for a period of two years from date of purchase except as hereinafter provided. This warranty extends only to the original purchaser (a purchase from Raytek or Raytek's licensed distributors is an original purchase). This warranty shall not apply to fuses or batteries. Factory calibration is warranted for a period of one year. The warranty shall not apply to any product which has been subject to misuse, neglect, accident, or abnormal conditions of operation or storage. Should Raytek be unable to repair or replace the product within a reasonable amount of time, purchaser's exclusive remedy shall be a refund of the purchase price upon return of the product.

In the event of failure of a product covered by this warranty, Raytek will repair the instrument when it is returned by the purchaser, freight prepaid, to an authorize Service Facility within the applicable warranty period, provided Raytek's examination discloses to its satisfaction that the product was defective. Raytek may, at its option, replace the product in lieu of repair. With regard to any covered product returned within the applicable warranty period, repairs or replacement will be made without charge and with return freight paid by Raytek, unless the failure was caused by misuse, neglect, accident, or abnormal conditions of operation or storage, in which case repairs will be billed at a reasonable cost. In such a case, an estimate will be submitted before work is started, if requested.

THE FOREGOING WARRANTY IS IN LIEU OF ALL OTHER WARRANTIES, EXPRESSED OR IMPLIED, INCLUDING BUT NOT LIMITED TO ANY IMPLIED WARRANTY OF MERCHANTABILITY, FITNESS, OR ADEQUACY FOR ANY PARTICULAR PURPOSE OR USE. RAYTEK SHALL NOT BE LIABLE FOR ANY SPECIAL, INCIDENTAL OR CONSEQUENTIAL DAMAGES, WHETHER IN CONTRACT, TORT, OR OTHERWISE.



Every change of the standard system design must be acknowledged from Raytek; otherwise the warranty of the complete system will be lost!



The device complies with the requirements of the European Directives.
EC – Directive 2004/108/EC (EMC)

Content

1. Safety Instructions	8
2. Technical Data	9
2.1 Specifications.....	9
2.2 Scope of Delivery	9
2.3 Weights and Dimensions.....	10
3. Description	12
4. Pre-Installation	13
4.1 Environment.....	13
4.2 Scanner Distance to Kiln.....	13
4.3 Scanner Alignment	14
4.4 Trigger Bar.....	14
4.5 Cable Requirements	14
4.6 PC Requirements	17
5. Installation.....	18
5.1 Mounting	18
5.2 System Connection Box	20
5.2.1 <i>Cable Entry System</i>	21
5.3 Fibre Optic / RJ45 Ethernet Converter	22
5.4 Position Indicator	23
5.5 Fibre Optic Converter Box.....	24
6. Configuration.....	25
6.1 Software Installation	25
6.2 CS Configuration	27
6.2.1 <General options>.....	28
6.2.1.1 <General settings> Tab.....	28
6.2.1.2 <Communications settings> Tab.....	29
6.2.1.3 <Mail setup> Tab.....	32
6.2.2 <Colours and axes definition>	33
6.2.2.1 <Colors> Tab	33
6.2.2.2 <Axes> Tab.....	33
6.2.3 <Position of Scanners / Pyrometers>.....	34
6.2.3.1 <i>Scanners or Pyrometers definition</i>	36
6.2.4 <Special Commands>	38
6.2.5 <Alarm zones>.....	39
6.2.5.1 <i>Repository of alarm zones configuration</i>	39
6.2.5.2 <i>Alarm Zone configuration detail</i>	39
6.2.5.3 <i>Alarm zone definition</i>	40
6.2.6 <Refractory>	41
6.2.6.1 <i>Repository of refractory configuration</i>	41
6.2.6.2 <i>Refractory configuration detail</i>	41
6.2.6.3 <i>Refractory zone definition</i>	42
6.2.7 <Historical management>	42
6.2.7.1 <Images> Tab.....	42
6.2.7.2 <Others> Tab.....	43

6.2.8 <LRM Configuration>	44
6.2.9 <Digital Output Management>.....	45
6.2.9.1 Repository of Digital Outputs	45
6.2.9.2 Digital Output Management detail.....	46
6.2.10 <Management of Errors>	47
6.2.10.1 Repository of errors	47
6.2.10.2 Error detail.....	48
6.2.10.3 Error list	49
6.2.11 <Management of Alarms>	50
6.2.11.1 Repository of alarms.....	50
6.2.11.2 Alarms detail.....	51
6.2.11.3 Alarms list	51
6.2.12 <Users>	52
6.2.12.1 Users Repository	52
6.2.12.2 User's detail	53
6.2.13 <Update ReadScan>.....	56
7. Operation.....	57
7.1 ReadScan	57
7.1.1 <Control> Tab	58
7.1.2 <Scanners> Tab.....	58
7.1.3 <Pyrometers> Tab	59
7.1.4 <LRM> Tab.....	59
7.1.5 <OPC Server> Tab.....	60
7.1.6 <Log> Tab	60
7.2 CS Runtime Software: Deneb	61
7.2.1 <Main> <Real time>	61
7.2.2 <Main> <Historic time> <Short term>	64
7.2.3 <Main> <Historic time> <Long term>.....	66
7.2.4 <Main> <Reference image>.....	66
7.2.5 <Secondary> <Internal temperatures>.....	66
7.2.6 <Secondary> <Burning zone graphic>.....	67
7.2.7 <Secondary> <LRM view>.....	67
7.2.7.1 <Kiln view> Tab.....	67
7.2.7.2 <Vertical> Tab.....	68
7.2.7.3 <Horizontal> Tab	68
7.2.7.4 <Time trend> Tab.....	69
7.2.7.5 <Space trend> Tab.....	69
7.2.8 <Special zones>	70
7.2.9 <Secondary> <Errors>	70
7.2.10 <Secondary> <Alarms>.....	71
7.2.11 <Graphic> <Histogram>	73
7.2.12 <Graphic> <Trend>.....	74
7.2.13 <Graphic> <Difference between images>	75
7.2.14 User defined Start-up of Deneb	76
8. Options	77
8.1 Start-up-Service	77
9. Accessories	78

9.1 Overview	78
9.2 Serial RS485 / RJ45 Ethernet Converter	79
9.2.1 <i>Technical Data</i>	79
9.2.2 <i>LED Indicators</i>	80
9.2.3 <i>Driver Installation</i>	80
9.3 Fan Control	83
9.3.1 <i>Technical Data</i>	83
9.3.2 <i>Installation</i>	83
9.4 LRM – Live Ring Migration	84
9.4.1 <i>Functionality</i>	84
9.4.2 <i>LRM Remote Control</i>	84
9.4.3 <i>Position Indicator</i>	85
9.4.4 <i>Wiring</i>	86
9.5 Shadow Monitoring	87
9.6 Burning Zone Monitoring	89
9.7 Internal Heater	91
10. Auxiliary Software	92
10.1 Managing the CS Database with DBCheck	92
10.1.1 <i>Starting the DBCheck application</i>	92
10.1.2 <i>Connecting to the database</i>	92
10.1.3 <i>Migrating pre-existing CS100 data</i>	93
10.1.4 <i>Import and export CS configurations</i>	94
10.1.5 <i>Creating a backup file</i>	95
10.1.6 <i>Reset database</i>	96
10.2 Remote Access from a Client PC	96
10.3 Device Testing Programme: PComm	97
10.3.1 <i><Check operation> Window</i>	97
10.3.1.1 <i>Scanner</i>	98
10.3.1.2 <i>Pyrometer</i>	98
10.3.1.3 <i>Digital Output</i>	99
10.3.1.4 <i>LRM</i>	100
11. Troubleshooting	101
12. Drawings	102
12.1 CS212 Installation without Accessories	102
12.2 CS212 Installation with Accessories	103
12.3 System Connection Box Wiring	104
12.4 Fibre Optic Converter Box Wiring	106
12.5 Position Indicator Wiring	107
12.6 Fan Control Wiring	108
12.7 LRM Wiring	109
12.7.1 <i>Wiring W8</i>	110
12.7.2 <i>Wiring W9</i>	111
12.8 Shadow Monitoring Wiring	112
12.9 Burning Zone Wiring	113
13. Appendix – Technical Data	114
13.1 Protective Housing	114

13.2 Connection Box	115
13.3 Fibre Optic / RJ45 Ethernet Converter.....	116
13.4 Connection Box for Accessories	117
13.5 Position Indicator	118
13.6 Output Modules	119
13.6.1 <i>Digital Output Module 7043 (16 channels)</i>	119
13.6.2 <i>Relay Output Module 7067 (7 channels)</i>	119
14. Notes.....	120

Safety Instructions

1. Safety Instructions

This document contains important information, which should be kept at all times with the system during its operational life. Other users of this instrument should be given these instructions with the instrument. Updates to this information must be added to the original document. The instrument can only be operated by trained personnel in accordance with these instructions and local safety regulations.

Acceptable Operation

This instrument is intended only for temperature measurement and is appropriate for continuous use. The instrument operates reliably in demanding conditions, such as in high environmental temperatures, as long as the documented specifications are adhered to. Compliance with the operating instructions is necessary to ensure the expected results.

Unacceptable Operation

The instrument should not be used for medical diagnosis.

Replacement Parts and Accessories

Use only original parts and accessories approved by the manufacturer. The use of other products can compromise the operational safety and functionality of the instrument.

Instrument Disposal



Do not dispose of this product as unsorted municipal waste. Go to Fluke's website for recycling information.

Operating Instructions

The following symbols are used to highlight essential safety information in the operation instructions:



Helpful information regarding the optimal use of the instrument.



Warnings concerning operation to avoid instrument damage and personal injury.



The instrument is equipped with a Class 2 laser. Class 2 lasers shine only within the visible spectrum at an intensity of 1 mW. Looking directly into the laser beam can produce a slight, temporary blinding effect, but does not result in physical injury or damage to the eyes, even when the beam is magnified by optical aids. At any rate, closing the eye lids is encouraged when eye contact is made with the laser beam. Pay attention to possible reflections of the laser beam. The laser functions only to locate and mark surface measurement targets. Do not aim the laser at people or animals.



Incorrect use of 110 / 230 V electrical systems can result in electrical hazards and personal injury. All instrument parts supplied with electricity must be covered to prevent physical contact and other hazards at all times.

2. Technical Data

2.1 Specifications

Linescanner

Type	MP150HR linescanner
Temperature range:	100 to 650°C (212 to 1202°F)
Optical resolution (90% energy)	170 : 1 (IFOV = 5,9 mrad) ¹
Spot detection (50% energy)	510 : 1 (IFOV = 2,0 mrad) ²
Spectral response:	3.5 to 4 µm
Scan angle (FOV):	90°
Accuracy:	± 0.5% of reading or ± 3°C (± 6°F) whichever is greater, at 0 - 50°C (32 - 122°F) ambient temperature for the scanner
Repeatability:	± 1°C (± 2°F), at 0 - 50°C (32 - 122°F) ambient temperature for the scanner
Detector:	HgCdTe
Sampling rate:	1024 pixel per scan line
Standard focal distance:	infinity
Mechanical scanning system:	MTBF: 40,000 hours
Power requirement:	85 to 264 VAC (for the system connection box in the field)
Protection rate:	IP65 (NEMA4) protection for linescanner
Ambient temperature range: (for scanner with housing) - without cooling:	-40 to 45°C (-40 to 113°F), no direct sunlight
Warm-up time:	20 minutes

System

Scan lines:	200
Min. kiln speed:	0.02 rpm (for synchronized measurement)
Max. kiln speed:	6 rpm @ 200 lines @ 20 Hz scan speed (for synchronized measurement)
Packaging:	CS211: about 40 kg (88 lb) CS212: about 80 kg (176 lb)

2.2 Scope of Delivery

The standard CS211 package includes:

Scanner:	Linescanner MP150HR (2 units for CS212) 7.5 m (24.6 ft) Ethernet cable 7.5 m (24.6 ft) power cable 7.5 m (24.6 ft) alarm/trigger cable
----------	---

¹ at 20 Hz scan speed

² at 20 Hz scan speed

Technical Data

	7.5 m (24.6 ft) RS485 cable
	Spare window
Protective Housing:	XXXSYSPHSS, stainless steel box, (2 units for CS212) grommet kit adjustable mounting bracket
Spare Window:	for protective housing, XXXSYSPHSW
Position Indicator:	High temperature inductive sensor with junction box (XXXSYSSECPI)
System Connection Box (field)	CS210CONBOX (two boxes CS210CONBOX for CS212) with: Fibre Optic / RJ45 Ethernet Converter: 4x Ethernet, 2x fibre optic channels and: Power Supply 110/230 VAC to 24 VDC, 2.5 A Fibre Optic patch cable with SC connector, 2 m (6.6 ft) - 2 pieces
Fibre Optic Converter Box	XXXHSFICBOX (control room) with: Fibre Optic / RJ45 Ethernet Converter: 4x Ethernet, 2x fibre optic channels and: Power Supply 110/230 VAC to 24 VDC, 1.25 A Ethernet patch cable, 2 m (6.6 ft) Fibre Optic patch cable with SC connector, 2 m (6.6 ft) - 2 pieces
Tool Kit:	Hex key wrench 2.5 mm Hex key wrench 4 mm Hex key wrench 5 mm Wrench 7x8 and 10x13 Key for locking/unlocking enclosure doors
DVD:	DataTemp CS Software (incl. manuals, presentations, tools)
Documentation:	CS210 Manual, MP150 Operating Instructions, MP150 Protocol Manual (on DVD only)

2.3 Weights and Dimensions

Linescanner:	Length: 180 mm (7.09 in)
	Width: 120 mm (4.72 in)
	Height: 200 mm (7.87 in)
	Weight: 7 kg (15.4 lbs)
Protective Housing:	Length: 300 mm (11.81 in)
	Width: 300 mm (11.81 in)
	Height: 300 mm (11.81 in)
	Weight: 8 kg (17.6 lbs)
Protective Housing: (with mounting bracket and protective sighting channel)	Length: 452 mm (17.79 in)
	Width: 496 mm (19.53 in)
	Height: 450 mm (17.72 in)
	Weight: 13 kg (28.6 lbs)

Position indicator:

Sensor head: Length: 50 mm (1.97 in)
 Diameter: 50 mm (M50 x 1,5) (1.97 in)
 Weight: 0.3 kg (0.66 lbs)

Junction box: Length: 84 mm (3.31 in)
 Length: 110 mm (4.33 in) with electronic tube
 Width: 79 mm (3.11 in)
 Height: 67 mm (2.64 in)
 Weight: 0.7 kg (1.5 lbs)

System Connection Box:

 Width: 380 mm (15 in)
 Height: 380 mm (15 in)
 Deep: 210 mm (8.3 in)
 Weight: 9.8 kg (22 lb) - netto

Description

3. Description

The Raytek CS210 is a comprehensive temperature measurement system for the monitoring, control, and analysis of rotating kiln shells used in cement and lime production, mineral processing, hazardous waste incineration and other processes. This system is a unique combination of hardware centered on the industry-leading MP150 linescanner and a powerful, industrial software package. The system allows accurate monitoring of the kiln shell and early detection of hot spots indicating damaged or missing refractory bricks, preventing costly kiln damage and extending production runs.

The key component of the CS210 system is an infrared linescanner (CS212 system: two linescanners). The linescanner collects infrared energy, emitted from the kiln surface allowing the system to measure the temperature along the length of the kiln.

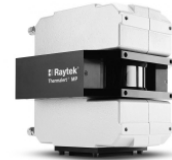

The CS210 system provides many features, which include full-color thermograms of the kiln surface, user defined alarms, automatic fan control and extensive historical data analysis capability. The CS210 system also adds OPC server functionality, a powerful SQL server for database applications, and full integration of all available accessories. Most notably, additional point sensors can be installed and configured to monitor portions of the kiln “shadowed” from the main sensor by physical obstructions and the results displayed as one homogenous thermogram. Similarly, a separate sensor is available to monitor the burning zone of the kiln and again the data will be seamlessly incorporated into one common display in the control room.

Using an optical fibre cable from the scanner in the field to the PC Ethernet interface in the control room is a reliable way for connecting. Using fibre optics, you can prevent electrical interference from corrupting the CS210 system. The optical fibre cable supports high speeds and long distance transmissions (up to 2 km / 1.2 mi). One fibre optic communication line only from the field to the control room minimizes the installation efforts on-site.

For a complete system overview see section 12.2 [CS212 Installation with Accessories](#), page 103.

4. Pre-Installation

The customer is responsible for preparation of the sensor stand, installation of the position indicator with the trigger bar and the complete field wiring as indicated in the appendix.

4.1 Environment



Please take note of the following:

- The maximum ambient temperature for the scanner within the protective housing is 45°C (113°F). If necessary, add an additional shaded roof to protect the protective housing from direct sunlight or provide water direct to the scanner.
- For details on grounding the sensor stand, please refer to the local building codes for lightning protection.
- The housing of the linescanner and the system connection box must have the same potential. (Check for good electrical contact at grounding wire connection).

4.2 Scanner Distance to Kiln

The standard system, CS211, is a one-scanner system and is suited for small to medium length kilns up to 60 m (200 ft) in length. For longer kilns the CS212, a two-scanner system, will be required.

The linescanner has a 90° scan angle. The distance between the scanner and the kiln required for complete coverage of the kiln length can be calculated as follows:

$$D \geq \frac{1}{2}L$$

where:

- D ... Distance between scanner and kiln
- L ... kiln length (required scan width)

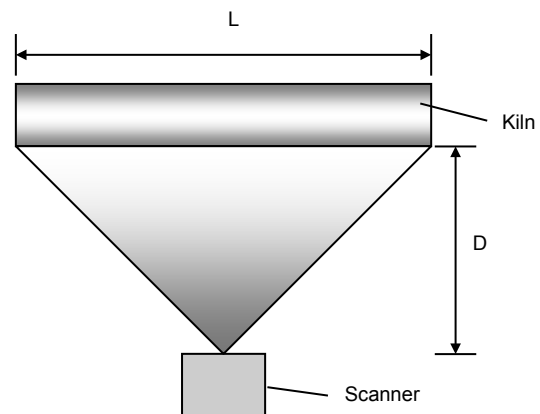

Figure 1: Distance between Scanner and Kiln

Pre-Installation

4.3 Scanner Alignment

The optimal scanner alignment is shown in the figure below.

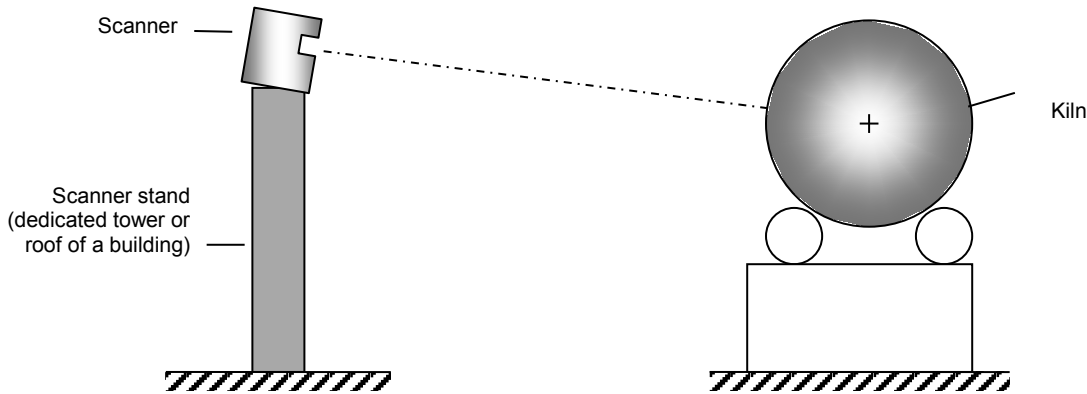

Figure 2: Alignment of Scanner

4.4 Trigger Bar

A position indicator is mounted on the “colder” end of the kiln and generates a trigger pulse once per revolution to supply the CS210 system with data on the rotational speed of the kiln. The installer must mount a trigger bar onto the kiln shell as shown in the figure below.

The maximum ambient temperature for the position indicator is 230°C (446°F). For installing the position indicator see section 5.4 [Position Indicator](#), page 23.

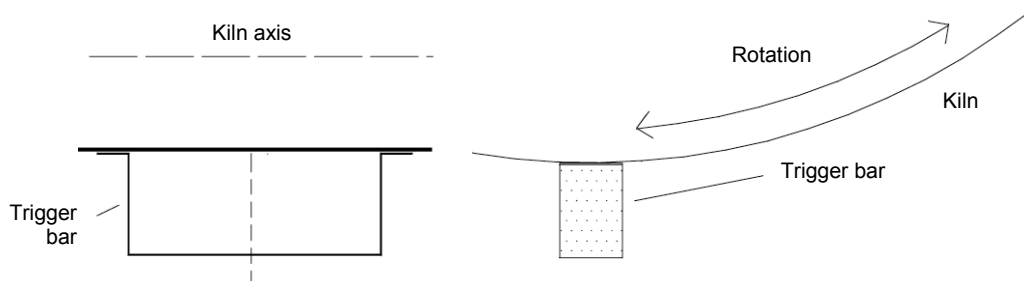

Figure 3: Welding the Trigger Bar on the Kiln

4.5 Cable Requirements

The following cables are necessary for standard installation, see also system drawings given in section 12.1 [CS212 Installation without Accessories](#), page 102.

- **W1** power supply cable for scanner (preinstalled with system connection box)
- **W2** RS485 communication cable for scanner (preinstalled with system connection box)
- **W3** trigger/alarm cable for linescanner (preinstalled with system connection box)
- **W8** from the junction box of the position indicator to the system connection box (standard installation) or to LRM remote control box (when used with accessory Live Ring Migration).
- **W9** from the LRM remote control box to the system connection box. This six-wire-cable is used for data communication, power supply, and trigger pulse.
- **W10** from the fan control output module to the system connection box. This four-wire-cable is used for data communication and power supply to the output module.

- **W14** from the MI connection box to the system connection box and between MI connection boxes when more than one shadow sensor is installed. This four-wire cable is used for data communication and power supply to the pyrometer.
- **W15** from the MR connection box to the system connection box. This six-wire cable is used for data communication and power supply to the pyrometer.
- **W16** MI sensing head cable.
- **W17** MR sensing head cable.
- **W18** Ethernet communication cable for scanner (preinstalled with system connection box)
- **W20** Fibre optic cable from system connection box to the control room and to the second scanner (if used). Fibre optic cable to be provided by customer.
- **W22** Ethernet cable from fibre optic converter (control room) to the PC.
- **W23** from the position indicator head to the junction box.
- **W24** Power supply cable 100 to 240 VAC.
- **W25** Fibre optic cable from the first scanner to the second scanner (if used). Fibre optic cable to be provided by customer.



All copper cables must be shielded! The wires from W9, W10, W14, and W15 must be a twisted pair! Local building codes should be observed when selecting cables!

Pre-Installation

Cable	Distance	Cable features	Supplied from ...	Example / Remarks
W1, W2, W3	7.5 m (25 ft.)	preinstalled	Raytek	
W8	350 m (380 yd)	3 x 0.25 mm ² , 24 AWG, 3 conductor, shielded	Customer	(N)YLHCY-J 3 x 0.25 mm ² Manhattan/CDT, P/N M13233
W9	350 m (380 yd)	3 x 2 x 0.25 mm ² , 24 AWG, 3x twisted pair, shielded	Customer	LifYCY 3 x 2 x 0.25 mm ²
W10	350 m (380 yd)	2 x 2 x 0.25 mm ² , 24 AWG, 2 x twisted pair, shielded	Customer	
W14	350 m (380 yd)	2 x 2 x 0.5 mm ² , 20 AWG, 2 x twisted pair, shielded	Customer	max. 5 pyrometers
	350 m (380 yd)	2 x 2 x 1.5 mm ² , 16 AWG, 2 x twisted pair, shielded	Customer	max. 14 pyrometers
W15	350 m (380 yd)	3 x 2 x 1.5 mm ² , 16 AWG, 3x twisted pair, shielded	Customer	
W16	8 m (26 ft)	preinstalled	Raytek	
W17	15 m (49 ft.)	preinstalled	Raytek	
W18	7.5 m (25 ft.)		Raytek	
W20	< 2 km (1.2 mi)	Fibre optic cable (outdoor), 2 fibres, multi-mode, 62.5/125 µm or 50/125 µm, equipped with SC connectors	Customer	Standard cable designation: A-DQ(ZN)B2Y...
W22	2 m (6.5 ft.)	Ethernet patch cable (CAT5, RJ-45)	Raytek	
W23	5 m (15 ft.)		Raytek	
W24		Power supply cable 100 to 240 VAC, 50 / 60 Hz, min. 3 x 1.5 mm ² (16 AWG)	Customer	NY Y
W25	< 2 km (1.2 mi)	Fibre optic cable (outdoor), 2 fibres, multi-mode, 62.5/125 µm or 50/125 µm, equipped with SC connectors	Customer	Standard cable designation: A-DQ(ZN)B2Y...



The cable length causes a certain voltage drop on the power cable. In case of using multiple sensors (MI shadow pyrometers via W14), longer cable lengths, or less gauges it must always be ensured, that the sensor will be supplied with the minimal voltage power!

Linescanner:	min. 18 VDC
MR burning zone pyrometer:	min. 20 VDC
MI shadow pyrometer:	min. 12 VDC

4.6 PC Requirements

Minimum Hardware requirement for CS211 and CS212:

- Processor: Pentium IV 2400 or higher
- 2 GB RAM
 - 1280 x 1024 pixel graphic card and monitor
(for displaying one scanner with 1024 pixel per line)
 - 2560 x 1600 pixel graphic card and monitor
(for displaying two scanners with 2048 pixel per line)
- 50 GB hard disk
- DVD drive
- Ethernet, TCP/IP protocol, 100 Mbit/s

Minimum Software requirement:

- Windows® XP or Windows 7³ with latest Service Pack



It is strongly recommended to run the CS software exclusively on the PC! Other applications could affect function and performance.



Make sure that a possible firewall does not block the following ports:

TCP/UDP Port	Server	Client	Remark
16500	CS Readscan	CS Deneb	
1433	CS SQL database	CS Config, CS Readscan	
25	CS Mail (SMTP)	CS Readscan	default
2727	Linescanner Communication	CS Readscan	default
5048, 5058	Serial RS485 / RJ45 Ethernet Converter	CS Readscan	as accessory only
23	Telnet		for service only

³ Windows Vista should work but it is not guaranteed.

Installation

5. Installation

5.1 Mounting

The linescanner protective housing requires a solid vibration-free mounting stand. The protective housing comes with a mounting bracket, adjustable 90° in all 3 axes. To mount the protective housing onto the sensor stand, e.g. on a tower, make a mounting plate with two 8.5 mm (0.31 in.) diameter mounting holes, as shown below. The mounting bracket is 150 mm (5.9 in) high.

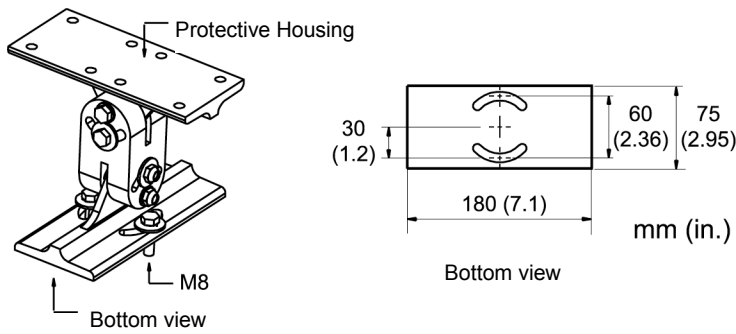

Figure 4: Protective housing's 3-axis mounting bracket

Preparing the protective housing to be mounted on the sensor stand

Open the protective housing from the back to access to the internal components. On the bottom of the box, there is a rail/carrier system on which the linescanner will be mounted. Open the latches on both sides of the rail, loosen the bolt on top of the carrier and take off the carrier. Mount the linescanner onto the carrier using the 4 M6 x 12 screws provided. Connect the earth ground to the top of the linescanner. To install the ground on the left mounting thread, use a M6 x 12 hex head screw with washer and lock washer.

Mounting the protective channel and the window

Open the front door of the protective housing. Mount the protective field-of-view channel on the front side by using 6 M4 x 12 bolts. The slotted side of the protection channel faces downwards. The bolts must be inserted from inside the box (i.e. the nuts are outside).



Make sure that the drain hole for rain water in the protective channel faces downwards!

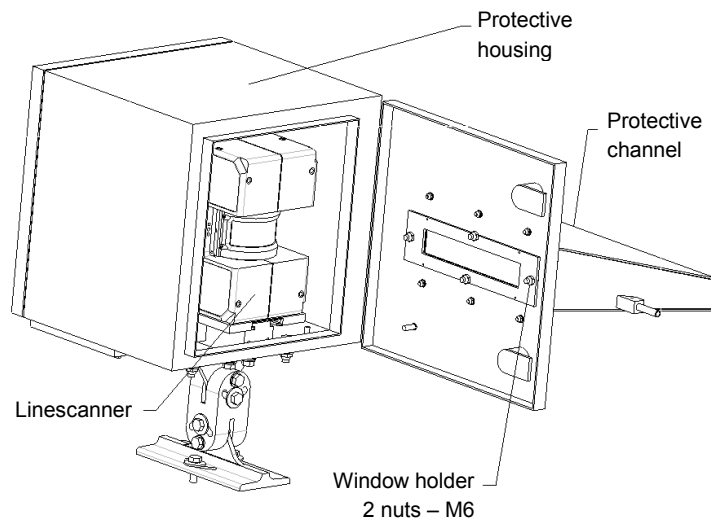

Figure 5: Protective housing with protective channel

Installing the linescanner

Open the back door. Insert the linescanner (with the mounted carrier) into the rail/carrier system. Lock in the linescanner in place with the latches and screw.

Electrical Installation

For best performance, the electrical installation of the CS210 System should correspond to one of the recommended installation configurations illustrated in section 12.1 [CS212 Installation without Accessories](#), page 102.

Connecting the cables

The cables W1, W2, W3, and W18 (located between the linescanner and the system connection box) are factory preinstalled and supplied along with the system connection box.

For running the cables through the protective housing: open one grommet plate (on the bottom of the protective housing) by loosening the three Allen-bolts. Use an appropriate grommet by considering the different cable outer diameters:

- Cable W1 (power supply): Ø 5 mm (0.2 in)
- Cable W18 (Ethernet): Ø 6 mm (0.24 in)
- Cable W2 (RS485) and W3 (Alarm/Trigger): Ø 7 mm (0.28 in)

Feed the cable through the grommets so that grommet is approximately 400 mm (15.7 in) away from the linescanner connectors (round plugs). Place the grommet plate over the grommets as shown in the figure below. Be careful to have the cable identification plates pointed toward the system connection box (longer end of the cables). Close unused holes with the blind grommets then close the grommet plate.

Installation



Figure 6: Cable installation

Using the 4 M5x25 screws, mount the grommet plate on the outside of the protective housing. Plug the cable connectors into the linescanner. Connect the socket and the plug for earth ground.



If installing the CS210 system in a warm environment, water-cooling may be necessary. The tubes used for water may be run through the second grommet plate!

5.2 System Connection Box

The system connection box connects all device field cables with the customer supplied optical fibre cable. The system connection box includes the Fibre Optic / RJ45 Ethernet Converter, the 24 VDC power supply and the Serial/Ethernet converter for supporting the accessories (if used).

The box is supplied with quick installation line-up terminals. For more technical data, see section 13.2 [Connection Box](#), page 115.

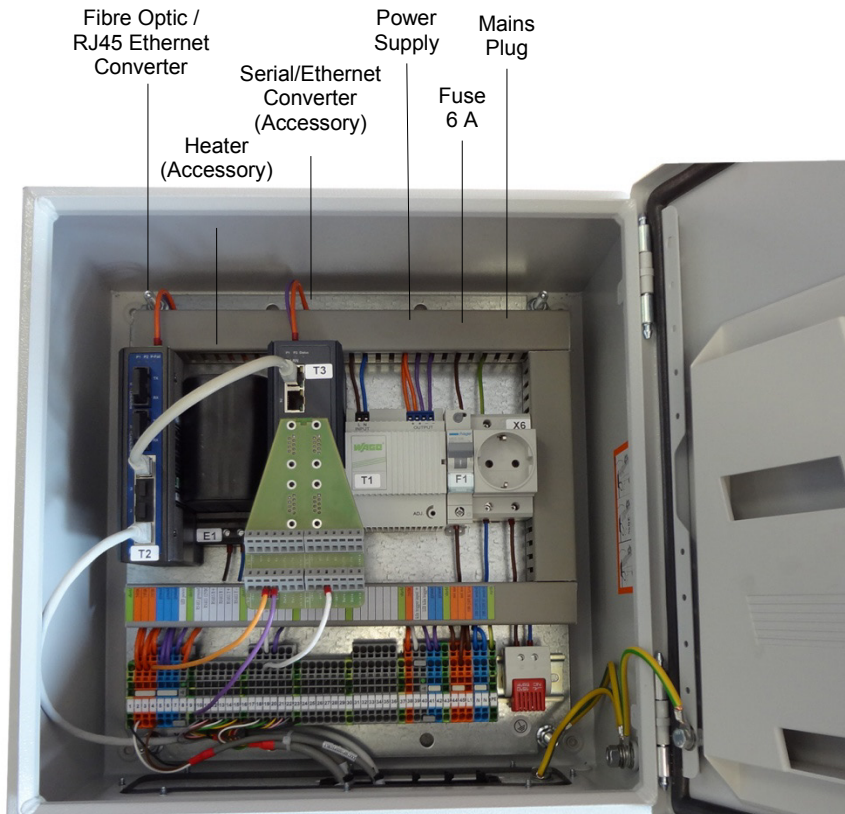

Figure 7: Opened System Connection Box

Installation

The system connection box can be mounted up to 7 meters (23 ft) away from the scanner. However to simplify aiming the scanner at the kiln it is the best that the connection box is mounted as close to the scanner as possible. The cables between the linescanner and the connection box needs to be protected from mechanical damage.

Mount the connection box in a convenient location. The cables W1, W2, W3, and W18 are factory preinstalled. Insert the cable W22 using the grommet plate taking care to select the correct grommet size for the cable diameter.

Connect the cables for the accessories with the connectors of the line-up terminal as described in section 12.3 [System Connection Box Wiring](#), page 104.

After double-checking all connections, switch the power on. The 24V-LED indicates the ON/OFF status (see terminal pin 8 in the system connection box). Check the trigger signal coming from the position indicator (see terminal pin 40 in the system connection box).

Pins 17 and 18 of the terminal in the system connection box connect to the internal alarm relay of the scanner. The contacts are potential free, the maximum load is 30 V / 1 A. To configure the alarm relay, see section 6.2.3.1 [Scanners or Pyrometers definition](#), page 36.

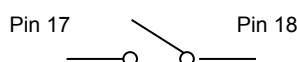
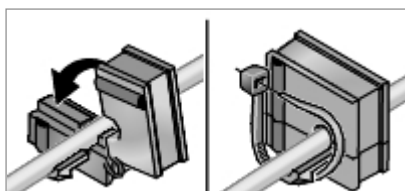

Figure 8: Connection to the internal Alarm Relay of the Scanner

5.2.1 Cable Entry System

The cable entry system is a split system that allows pre-assembled cables to be routed into the system connection box without disassembling the connectors.

Snap-on mounting⁴



Lay cable into appropriate grommet and provide strain relief where necessary using cable ties.

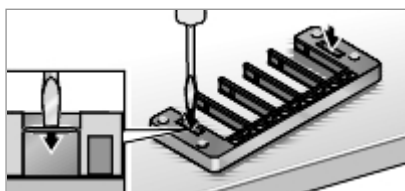

Use appropriate tool to punch through cover on base frame.

⁴ Illustrations: © Murrplastik

Installation

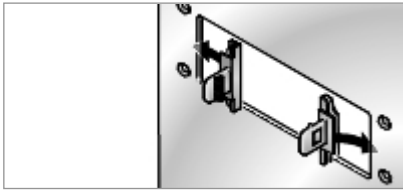

Set catch hooks into the sides of the cut-out.

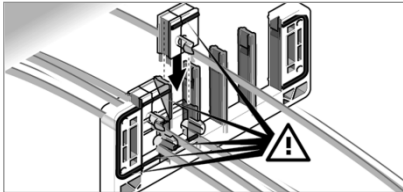

Insert rail completely.

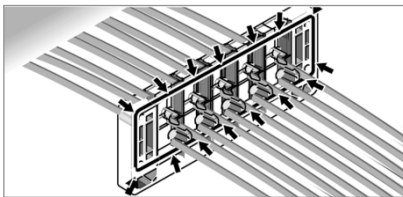

The grommet must produce a continuous seal on the back side.

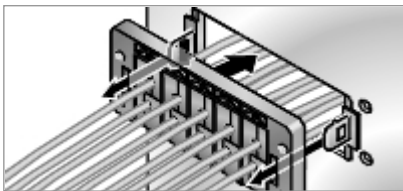

Set the rail onto the catch hooks and press on.

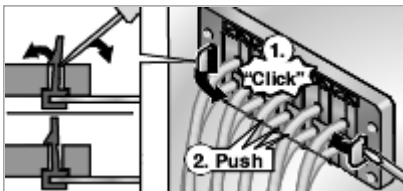

Lock the catch hooks with the rail. Press gently on grommet one more time.

5.3 Fibre Optic / RJ45 Ethernet Converter

The Fibre Optic / RJ45 Ethernet Converter assures high reliability and stability in harsh environments, making it a robust bridge between enterprise fibre-optic backbones and Ethernet devices like the linescanner. Using fibre optics, you prevent electrical interference from corrupting the CS210 system. The Fibre Optic / RJ45 Ethernet Converter supports fast speed and high distance transmissions. Copper based Ethernet communication is very limited in length without using a repeater.

The Fibre Optic / RJ45 Ethernet Converter in the system connection box is converting up to 4 Ethernet channels to support one or two scanners and the CS210 accessories. The Fibre Optic / RJ45 Ethernet Converter in the control room is converting the glass fibre signals back to TCP/IP Ethernet again. For further technical details see appendix 13.3 [Fibre Optic / RJ45 Ethernet Converter](#), page 116.



5.4 Position Indicator

The position indicator is a temperature resistant inductive proximity switch used to synchronize the scanning system with the kiln rotation.

The position indicator consists of two parts, a high temperature sensor head, and a junction box. Since the maximum ambient temperature allowed is 230°C (446°F), the sensor may be mounted near the kiln's surface. For the junction box a maximum ambient temperature of 70°C (158°F) is allowed. For further technical details see appendix 13.5 [Position Indicator](#), page 118.



Both components, sensor and junction box, are connected via a high temperature cable (length: 5 m / 15 ft). Protecting the cable against mechanical stress is recommended. Since the position indicator is necessary to generate a trigger pulse for the CS210 system, a trigger bar must be welded onto the "colder" end of the kiln and if possible close to the drive ring (see [Figure 9](#)).

The distance between the trigger bar and the position indicator is a very important parameter for correct operation. If the distance is too small, the trigger bar can destroy the sensor head. On the other hand, if the distance is too big, the position indicator will be unable to detect the trigger bar. Thus, it will not be able to generate the trigger pulse for the system.



In the case of a non-existing trigger signal, the system switches to the non-synchronized mode. In this mode, a yellow bar on the top area in the CS software will blink continuously. Non-synchronized thermograms are not stored in the database!

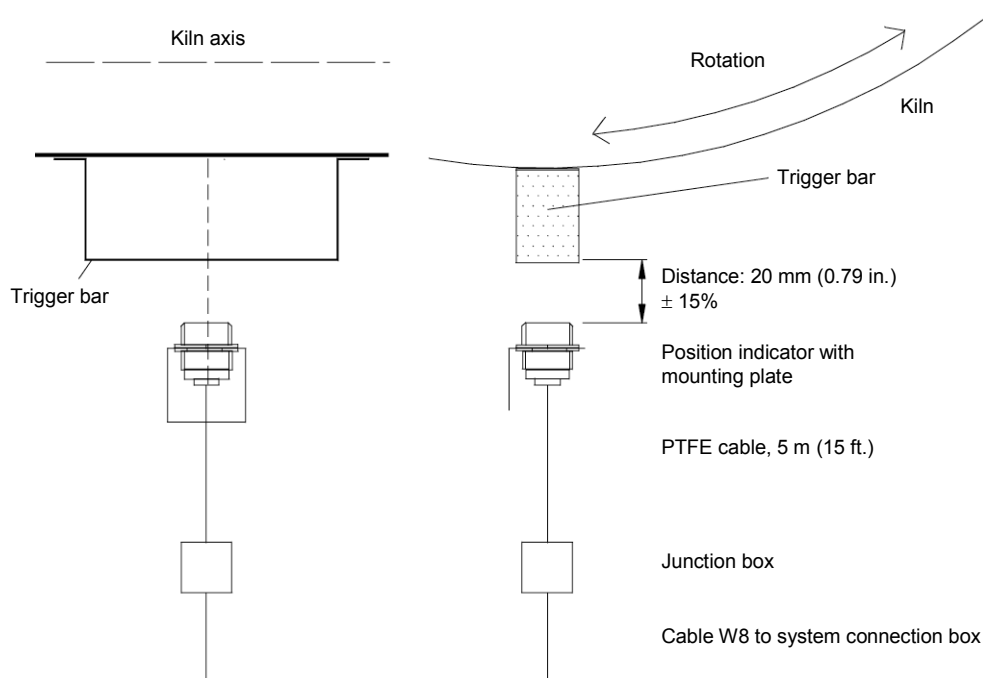

Figure 9: Mounting the Position Indicator

Adjustment of the position indicator:

1. Mount the trigger bar.
2. Mount the position indicator mounting plate .

Installation

3. Check the distance between position indicator and trigger bar.
4. Lock the position indicator in place and monitor its' operation. With each revolution of the kiln you should obtain a trigger pulse indicated by an LED in the junction box (field).

5.5 Fibre Optic Converter Box

The Fibre Optic Converter Box is located in the control room and connects the fibre optic cable from the field to the Ethernet interface of the computer. For more technical data, see section 13.2 [Connection Box](#), page 115.



Figure 10: Fibre Optic Converter Box

6. Configuration

The following sections of this manual describe the operation of the CS software. Complete configuration requires the following steps:

1. Install the software.
2. Configure the system.
 - a. Provide detail of certain general options.
 - b. Define detail of visual appearance options.
 - c. Define temperature reading instruments (scanners and pyrometers).
 - d. List alarm zones and refractory details.
 - e. Need for controlling of fans
 - f. Provide detail of the LRM system installation.
 - g. Define preferences for storing historical data.

Before proceeding with the following sections please ensure that the physical installation (communication and power wiring, air, water if necessary, etc.) is completed and working satisfactorily.

6.1 Software Installation

The software installation requires the user as administrator with full permission whereby the administrator requires a dedicated password!



It is strongly recommended to update the Windows operating system before installing the CS software!

Make sure that the default SQL port 1433 is not in use, otherwise you will be not able to install the software.

Insert the software DVD in the DVD drive and double click on the <Setup.exe> file. The install setup application will start, showing the following steps in a screen window.

- When the install setup starts up, a welcome screen will show, letting you select the default language for the application. Once you have selected the language, click on <Next> to continue.
- Next, select the path where you want to install the application and the folder where you want the database to be installed. When finished, click on <Next>.

Configuration

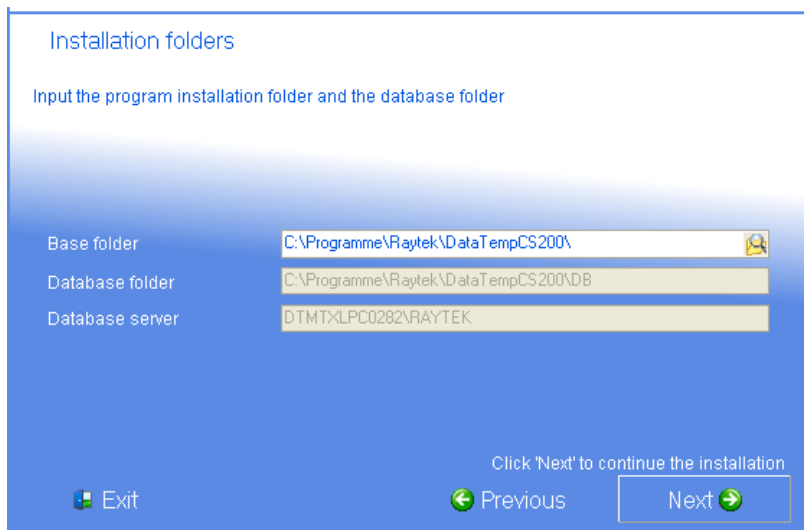

Figure 11: Installation screen

- Once you have completed selecting your preferences, you can click on <Install> to proceed with the installation.
- In one of the next screens, you have to give a valid <user name> and <password> for an administrative user for a domain on the installation computer to allow the SQL database server to be executed.

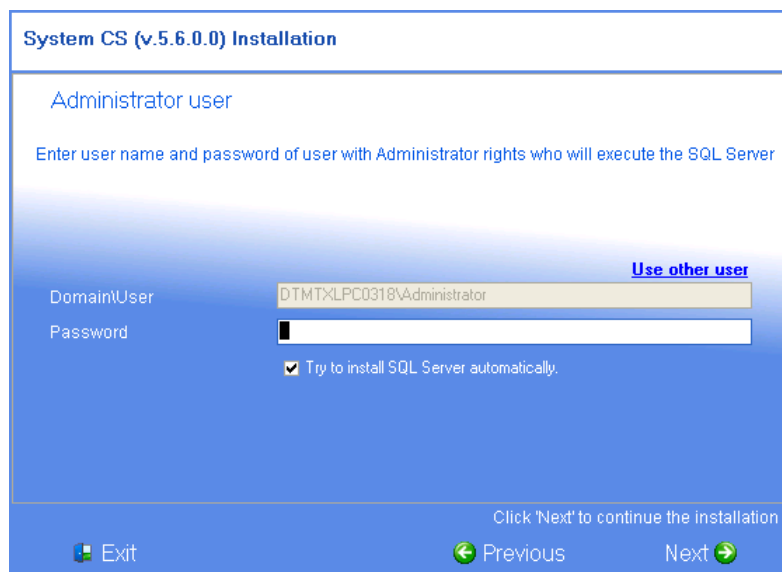

Figure 12: Administrative User for the Computer Domain



In case of installation problems uncheck the <Try to install SQL Server automatically> item!

- On the last installation screen, you can activate the check box to import an old CS100 configuration and a CS100 database into CS software. After closing the install setup you will

be guided through the migration procedure.

In addition, you find also the check box to start automatically ReadScan when Windows starts. It is strongly recommended to keep this check box enabled!

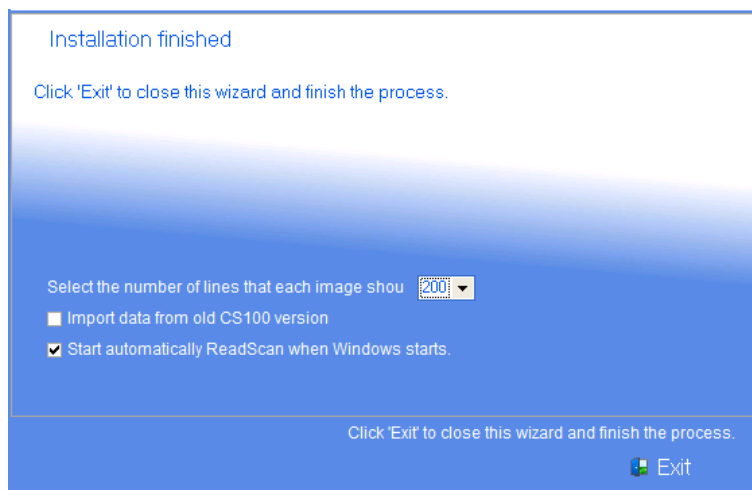

Figure 13: Installation finished

- If the installation is successful, all necessary shortcut icons will appear in your PC desktop screen and in the Start-menu (Start \ Programs \ Raytek \ DataTemp CS).



For Windows Vista and Windows 7 operating systems, the user data will be stored in the dedicated <My Documents> folder separately from the program files!

6.2 CS Configuration

To configure the DataTemp CS software, select the start menu, activate the CS program group and click on the icon <CS Config> (alternatively you can also find the icon on the desktop). You will be prompted to enter a password.

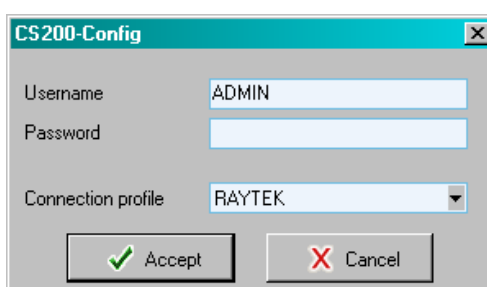

Figure 14: Authentication screen

At this point, a valid user and password must be entered for the selected profile. If this is the first login, a single profile will be seen, and that profile is normally <Raytek>.

Predetermined user for CS Config (valid also for the program components CS Deneb and ReadScan):

Configuration

Username: <ADMIN>
Password: {empty}

Once these 3 boxes are correctly filled, the user will proceed to a new screen and select the different menu options.



When ReadScan is active, any changes made in the configuration settings won't be effective until ReadScan restarts automatically later. For more information on this topic see section 7.1.1 <Control> Tab, page 58.

6.2.1 <General options>

6.2.1.1 <General settings> Tab

This tab allows the user to configure the general aspects of the system, such as description, language, maximum and minimum temperature to be seen from Deneb, the amount of lines formed per thermogram and metric or imperial units. In standard installations the scanner communicates via Ethernet, there are no speed restrictions to consider.

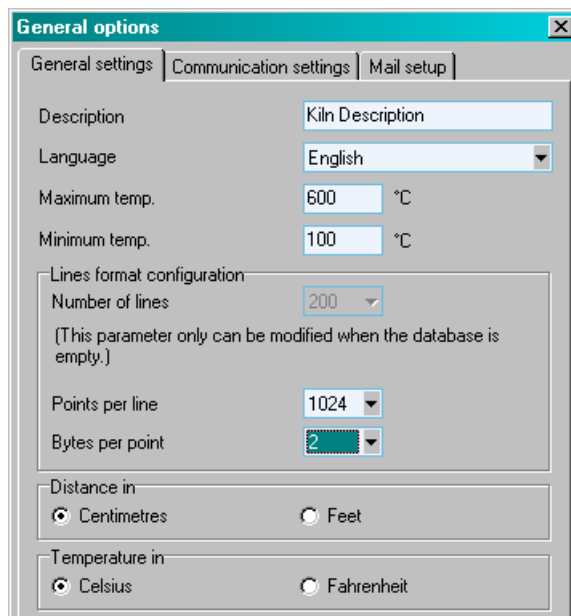

Figure 15: General options: <General Settings> Tab



It is strongly recommended to select the requested physical units (distance and temperature) before all others changes!



The number of lines per thermogram is a parameter that can only be modified when the database is empty, (i.e. when the database does not contain any images)!



For running of non-western European languages (Turkish, Russian) it is strongly recommended to use a Windows Operating System in that desired language!

Non-western European languages can also be displayed by setting the Windows codepage accordingly.

- Go to <Start> <Settings> <Control Panel> <Regional and Language Settings>
- Under <Regional Settings> select the desired language
- Under <Advanced> select the same desired language for programmes not supporting Unicode fonts

For old systems only, running with RS485 communications:

The number of data points per line and the number of bytes per data point needs to be considered in case of running the scanner via the serial RS485 communication line. The table below shows the recommended configurations.

<Points per line> defines the number of data points per line provided by one scanner.

<Bytes per point> defines the number of bytes per one data point.

Points per line	Bytes per point	Minimum serial speed
256	1	115 kBaud
512	1	115 kBaud

Figure 16: Recommended Configurations for the Serial RS485 Communication

6.2.1.2 <Communications settings> Tab

On this tab the user can configure general communication settings for the serial devices.

The <command timeout> is the maximum time to wait after sending one command to a device. If the device doesn't answer in less than the time stipulated, the system will consider it as a communication error.

The <communication timeout> is the time period between a communication error with a device and the systems attempt to retry the communication.

<Retries for communication> defines the number of automatic trials to re-establish the communication to a lost serial device.

By labeling the checkbox <OPC Server active>, the CS software runs as OPC server for one or more OPC clients within a network. For interfacing to other control systems this option allows the remote monitoring of the process.

OPC (OLE for Process Control) is an industrial standard for the data exchange between applications based on the DCOM model from Microsoft. For further information see <http://www.opcfoundation.org/>



The CS OPC server supports Data Access in version 2.0 only!

Configuration

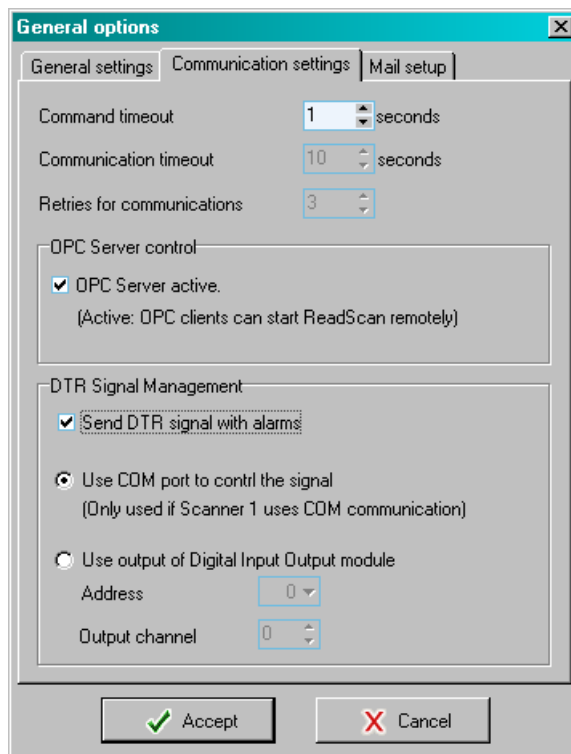

Figure 17: General Options: <Communication settings> Tab

<Send DTR signal with alarms> enables the output of a system alarm signal via the CS interface box (for scanners communicating via COM) or a digital output module (for scanners communicating via Ethernet).

Configuration

The CS software provides the following data via OPC connections. All items listed below have read-only access.

Item	Type	Description
Synchronization		
.System is synchronized	Bool	Flag for indicating that the system runs synchronized to the oven
Graphic		
.Maximum temperatures	Integer array	Provides the Maximum Temperature Profile (temperature via pixel number)
.Minimum temperatures	Integer array	Provides the Minimum Temperature Profile (temperature via pixel number)
.Average temperatures	Integer array	Provides the Average Temperature Profile (temperature via pixel number)
Live Ring Migration system		
.Rings	Integer	Number of rings currently used for Live Ring Migration
.Ring 1.Time	Integer	Revolution time for ring 1
.Ring 1.Offset	Integer	Offset time for ring 1 compared to kiln revolution time
.Ring 1.State	Bool	Status for ring 1
Alarm zones		
.Zone 1.Maximum temperature limit	Integer	Upper alarm threshold for zone 1
.Zone 1.Hysteresis (low)	Integer	Hysteresis for zone 1 (reset threshold for an alarm)
.Zone 1.Maximum temperature	Integer	Maximum temperature for zone 1
.Zone 1.Alarm State	Bool	Alarm status for zone 1
Devices		
.Kiln.Rotation velocity	Integer	Rotation velocity for the kiln given in rpm
.Kiln.Lap time	Integer	Rotation time for the kiln
.Kiln.Snapshot Counter	Integer	Snapshot counter, will be increased by 1 with each new stored image into the database, can be used as live counter
.Kiln.Points of reading	Integer array	Provides the Length Profile of the kiln (location of each pixel)
.Scanner 1.State	Bool	Status for scanner 1
.Scanner 1.Internal temperature	Integer	Internal temperature for scanner 1
.Pyrometer 1.State	Bool	Status for pyrometer 1
.Pyrometer 1.Internal temperature	Integer	Internal temperature for pyrometer 1
.Pyrometer 1.Maximum temperature	Integer	Maximum temperature for pyrometer 1
.Pyrometer 1.Dirty lens alarm limit	Integer	Threshold for dirty lens alarm for pyrometer 1 (shadow pyrometer only)
.Pyrometer 1.Dirty lens alarm state	Bool	Dirty lens alarm status for pyrometer 1 (shadow pyrometer only)
.Pyrometer 1.Type	String	Pyrometer used for: <burningZone> or <shadowPyrometer>
.Pyrometer 2.Burning zone	Integer	Temperature of the burning zone for pyrometer 2 (burning zone pyrometer only)

Configuration

6.2.1.3 <Mail setup> Tab

This tab lets you define the properties of the outgoing mail server to be used by the system. A typical setting for the SMTP port is 25.

For your correct Email settings, ask your network administrator.

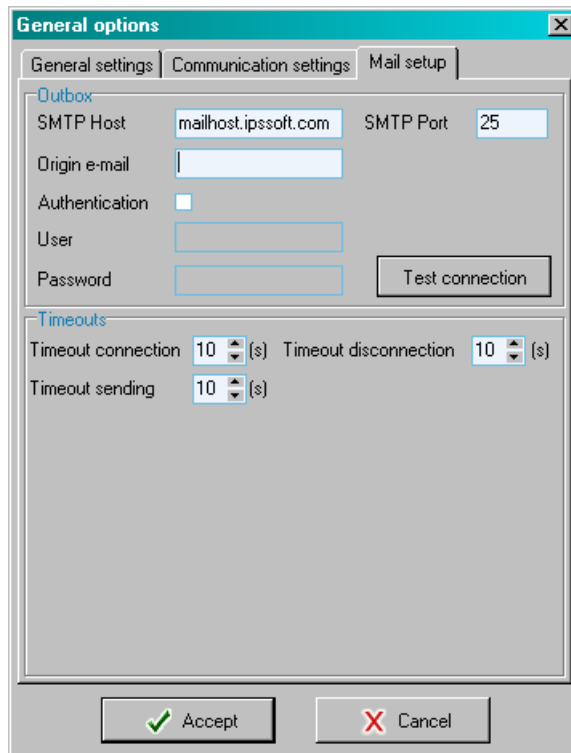

Figure 18: General options: <Mail setup> Tab – Configuring Outgoing Emails

To configure the email address for the recipient see section 6.2.12.2.1 <General> Tab, page 53.

To configure an email be sent in the event of an alarm see section 6.2.12.2.3 <Others> Tab, page 55, under <Readscan>.

```
Von: raytek@gmx.de
Gesendet: Dienstag, 6. November 2007 10:48
An:
Betreff: New alarm in CS200 system

Start : 06.11.2007 10:47:32
Device : Scanner 1
Type : Alarm zone
Temperature : 160 °C
Additional info. :
Zone 1 : The temperature is greater than the maximum allowed (150 °C)
```

Figure 19: Example for an Outgoing Alarm Email

6.2.2 <Colours and axes definition>

6.2.2.1 <Colors> Tab

With this tabbed dialog box, the user can define their options for the thermogram colour palette. To select colours, click on the RGB colours. <Scales> sets the number of colours to be included as the palette colours. Blending is possible by selecting the <Color progression> option.

The <Range> value defines the temperature scale range of the temperature difference view in the CS main software.

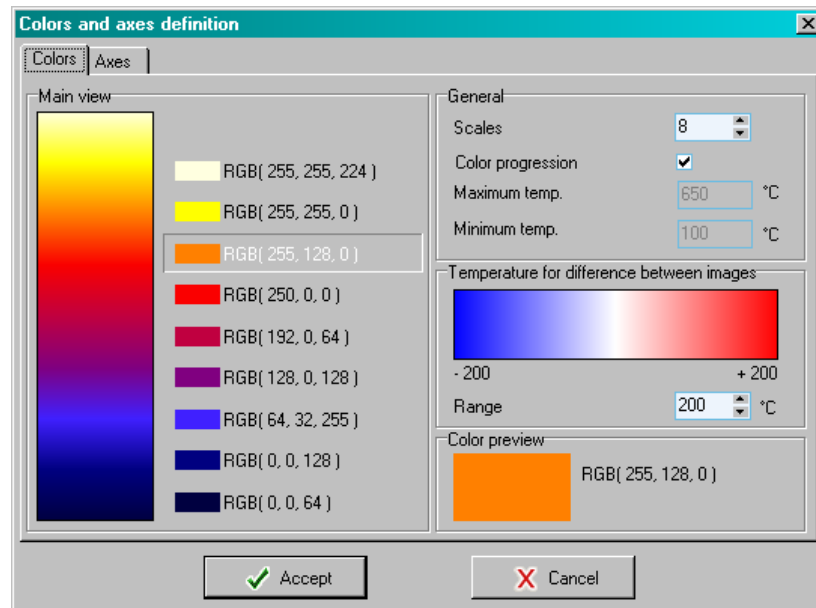

Figure 20: Colours and axes definition: <Colours> Tab

6.2.2.2 <Axes> Tab

This tab lets you configure the appearance for the different axes shown in the graphical representation of the thermogram, as well as the units representing the kiln diameter.

It also lets you configure the type font used for the axes in the graphical representation of the thermogram.

Configuration

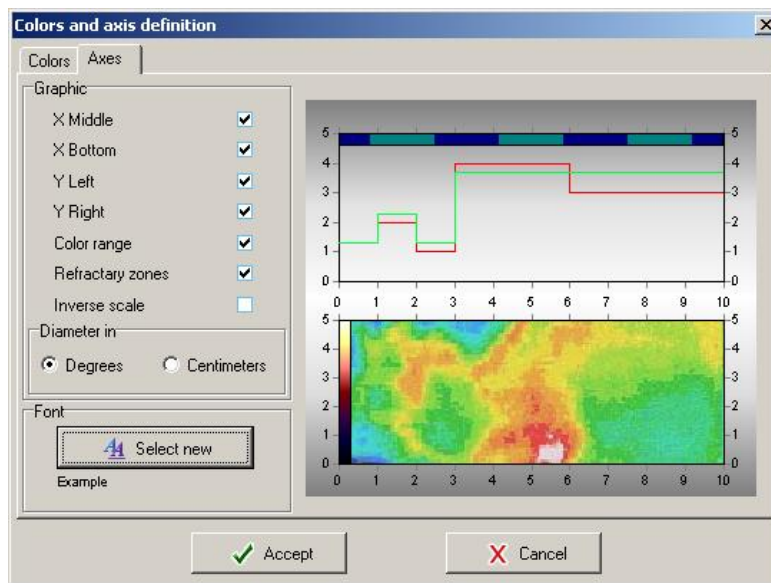

Figure 21: Colours and axes definition: <Axes> Tab



The option <Inverse scale> only affects the labels of the screen 'x' axis. When this option is selected, the actual optical parameters of the scanners and pyrometers will not be affected!

6.2.3 <Position of Scanners / Pyrometers>

On this screen the user configures two sets of information about the installation: on one hand, the characteristics of the kiln to be monitored, and on the other hand, the characteristics of the several devices (scanners and pyrometers) that will be used to monitor the kiln temperature.

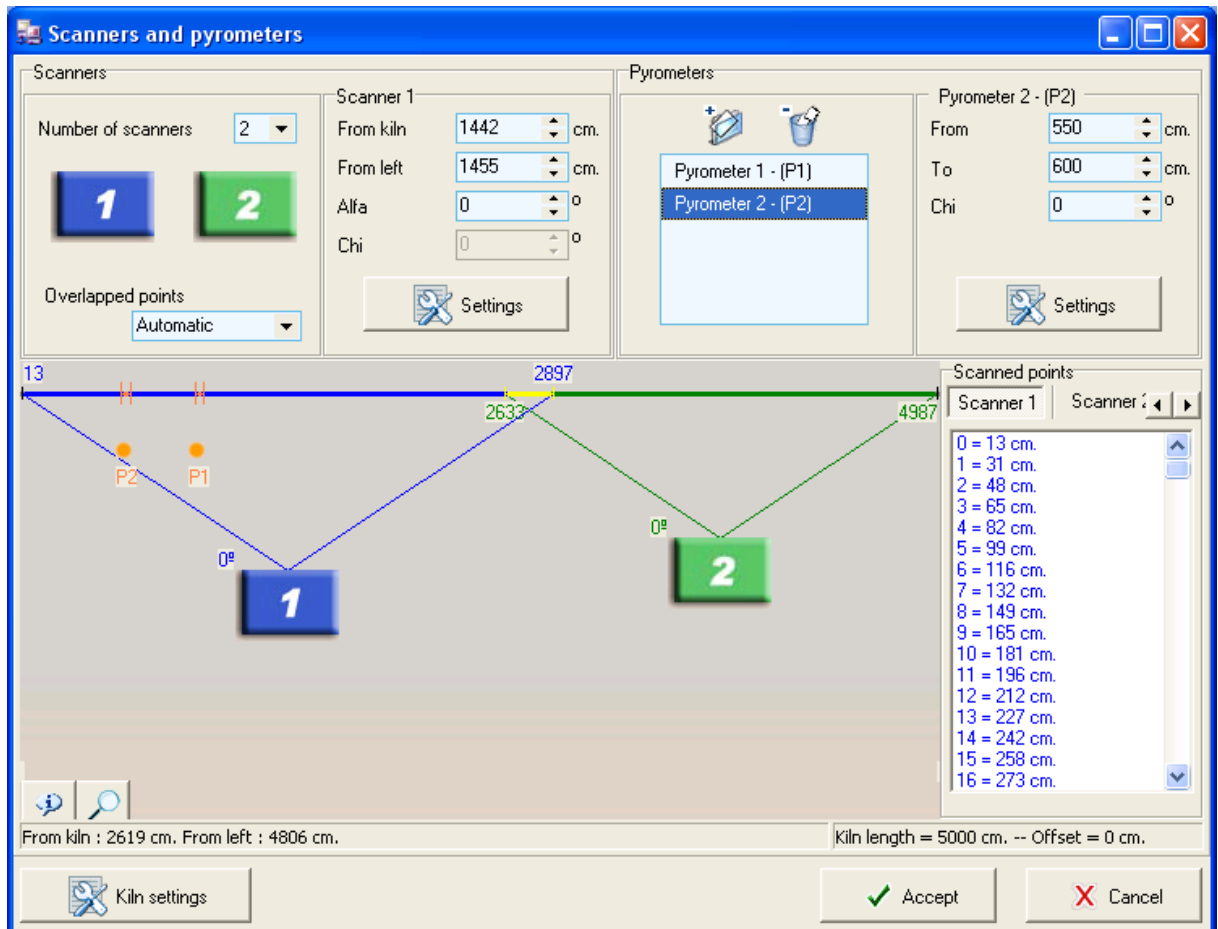

Figure 22: Scanners Position

The features for the different devices (scanners and pyrometers/shadow sensors) are displayed on the screen on the basis of the type of device: the top-left area is assign to scanners, and the top-right one is assign to pyrometers. The different devices and their positions are displayed on the centre of the screen. However, there are few general parameters that must be modified from the screens shown when clicking on the <Configuration> buttons.

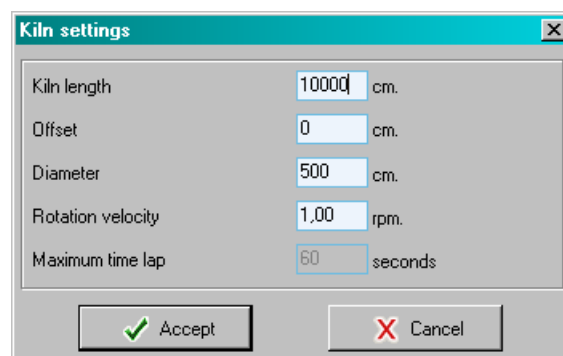

Figure 23: Kiln settings

Clicking the <Kiln settings> button will open a screen where details about the kiln can be entered. These specifications are the kiln size (length and diameter) and the longitudinal offset. The

Configuration

longitudinal offset only affects the labels of the screen x-axis. The actual optical parameters of the scanners and pyrometers are not affected.

<Rotation velocity> is the parameter that defines the minimum kiln speed that the system expects before launching a non-synchronized alarm. When not synchronized, the system will not save any images into the database. The <Real time> view shows scanned lines based on a simulated kiln speed of <Rotation velocity>. The minimum kiln speed for synchronized measurements is 0.02 rpm.



A kiln speed below <Rotation velocity> and a missing trigger pulse are the two main reasons for a non-synchronized alarm!

The position of the scanners can be adapted very comfortably by using the mouse. For doing so, make a right mouse click in the drawing area to open the context menu <Settings>. Being in that mode, the left/right cursor keys can be used to change the Alpha angle dynamically.

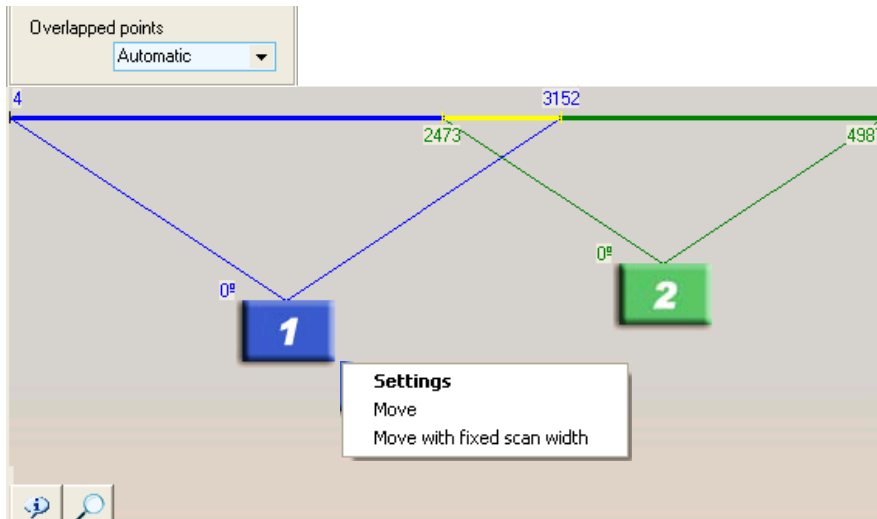

Figure 24: Positioning the Scanner

For two scanner systems there is with <Overlapping points> an additional mode available to determine the programs behaviour in the overlapping area:

- <Scanner 1>: Scanner 1 provides the pixel in the overlapping area for the final merged thermal image
- <Scanner 2>: Scanner 2 provides the pixel in the overlapping area for the final merged thermal image
- <Automatic>: the program internal algorithm determines which the pixel in the overlapping area will be taken for the final merged thermal image either from scanner 1 or scanner 2. The automatic mode is always useful if one scanner is being hindered from monitoring the complete kiln by physical obstructions and also by shadows from the tires but the other scanner is not.

6.2.3.1 Scanners or Pyrometers definition

From this screen you can configure the communication parameters and the device emissivity/transmission setting. It is also possible to assign an output for the alarm in case the internal

temperature exceeds the maximum setting. The parameters that we are describing are applicable for scanners and also for pyrometers.

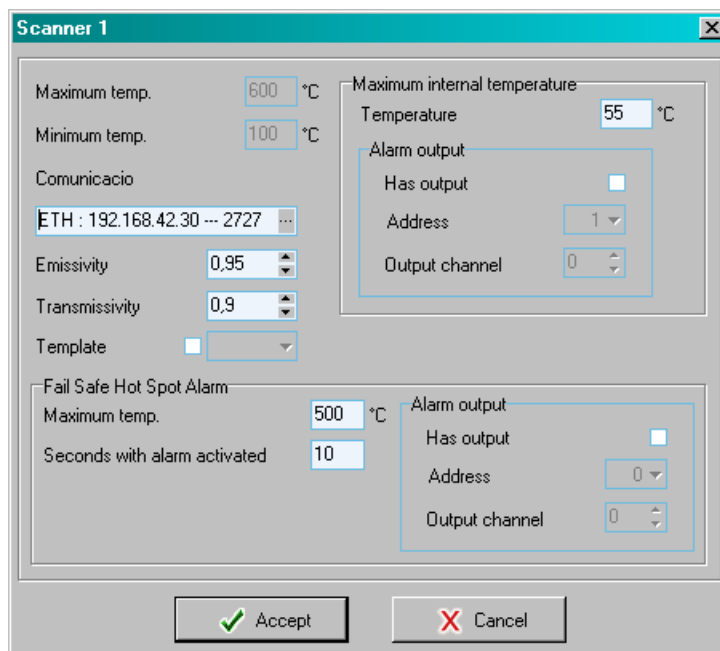

Figure 25: Definition of the Scanner device

On scanners only, you can define these additional parameters:

- Communication parameters for the scanner:
Ethernet: <IP Address> for the scanner (default: **192.168.42.30** for the first scanner; **192.168.42.31** for a second scanner) and <Port> (default: 2727)
For further information to configure the Ethernet communication for scanner and PC network adapter, see MP150 manual. Please note that a second scanner requires a different IP address!
COM: Port number and baud rate

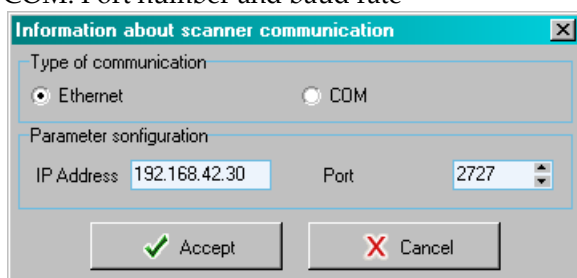

Figure 26: Parameter for the Scanner Communication

- The execution of a template already defined in section 6.2.4 <Special Commands>, page 38. This template contains scanner commands being executed when ReadScan is initialized.
- The triggering of the scanner <Fail Safe Hot Spot Alarm>. To increase the reliability of the system it is necessary to guarantee fail-safe hot spot alarming even in the event of a PC or software crash. For that reason the scanner provides an internal relay that will generate an alarm if a hot spot that exceeds user-defined limits is detected within the 90° scanner field of view. The relay contacts are available on the terminal line in the system connection box, see Figure 8 [Connection to the internal Alarm Relay](#), on page 21.

Configuration

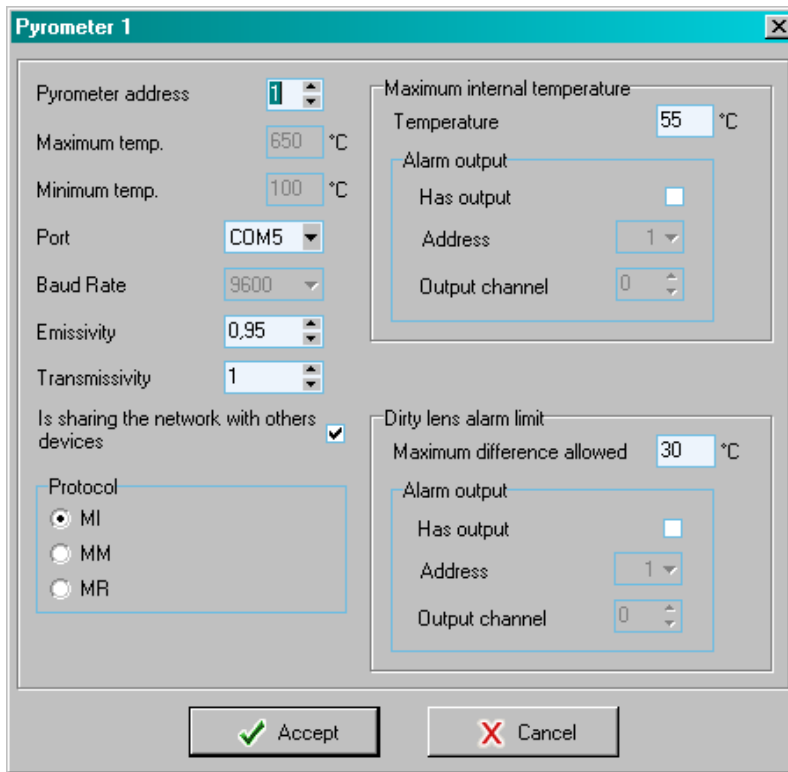

Figure 27: Definition for Pyrometer devices

For pyrometers you can define if it shares network with other pyrometers or not. When sharing the network, it will be necessary to indicate the unit address. Also, on this screen it is possible to set the dirty lens alarm and to configure one possible digital output for it.

6.2.4 <Special Commands>

This library allows the user to execute commands either individually or as groups via the command groups (templates) function.

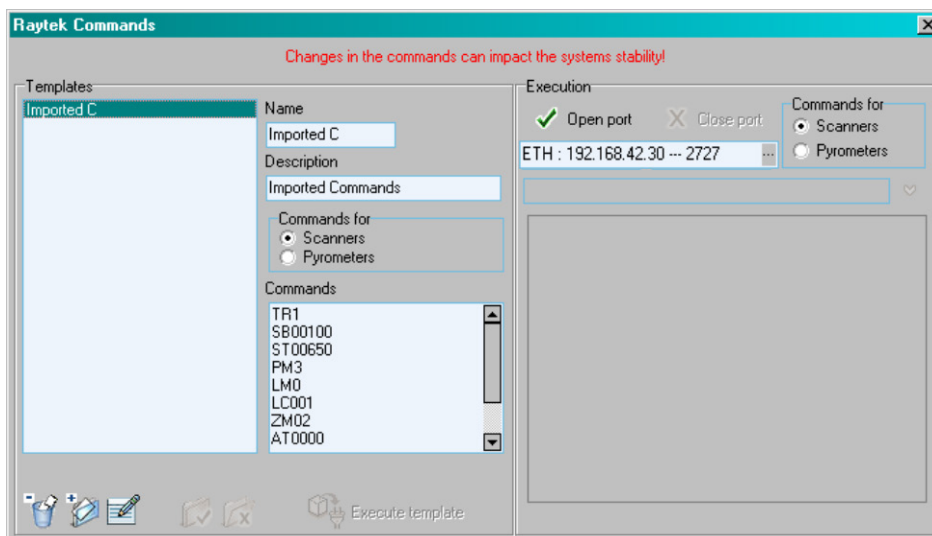

Figure 28: Window of Raytek Commands

In order to create a template you must enter the name, the description, and the commands to be executed, indicating if such commands are for Scanners or for Pyrometers.

You will also be able to delete and modify these templates.

To execute a command group you must first select the template, the port and the connection speed. After that, click on the button to open the port. Once the connection with the device has been established, the <Execute template> button will be active.

It is also possible to send a single command to a device. In such a case, you need only to select the type of device, the port and the connection speed. Then you will have to open the port and introduce the command to be executed. Afterwards, click on the button to run it.



Wrong set commands can suspend the whole CS210 system!

6.2.5 <Alarm zones>

6.2.5.1 Repository of alarm zones configuration

Within the CS software platform, several alarm zone configurations can be defined to accommodate different parameters of kiln operation. This screen shows all of the alarm zone configurations existing in the system. Obviously, just one of them can be active at any given time selectable by the <Set active> button.

The buttons along the lower toolbar are used to create new configurations, and also to edit or delete existing ones.

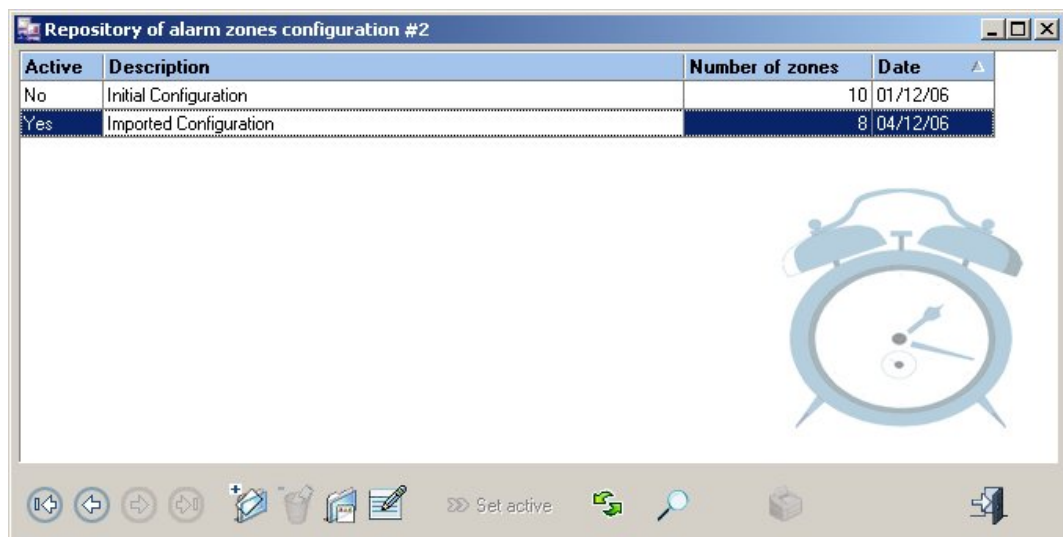

Figure 29: Managing of alarm zone configurations

6.2.5.2 Alarm Zone configuration detail

Clicking on any alarm zone configuration will open an Alarm Zone configuration detail screen. The alarm zones will be displayed on a mimic diagram along with some basic configuration information along the bottom of the screen. Click on any zone to see more detailed configuration information.

Configuration

It is possible to adjust the size of a zone directly in that dialog box. To do this, you need to drag the edges of the lower bar (adjacent to the Zone number) corresponding to the zone to be edited.

By a right mouse click an existing zone can be split into two ones.

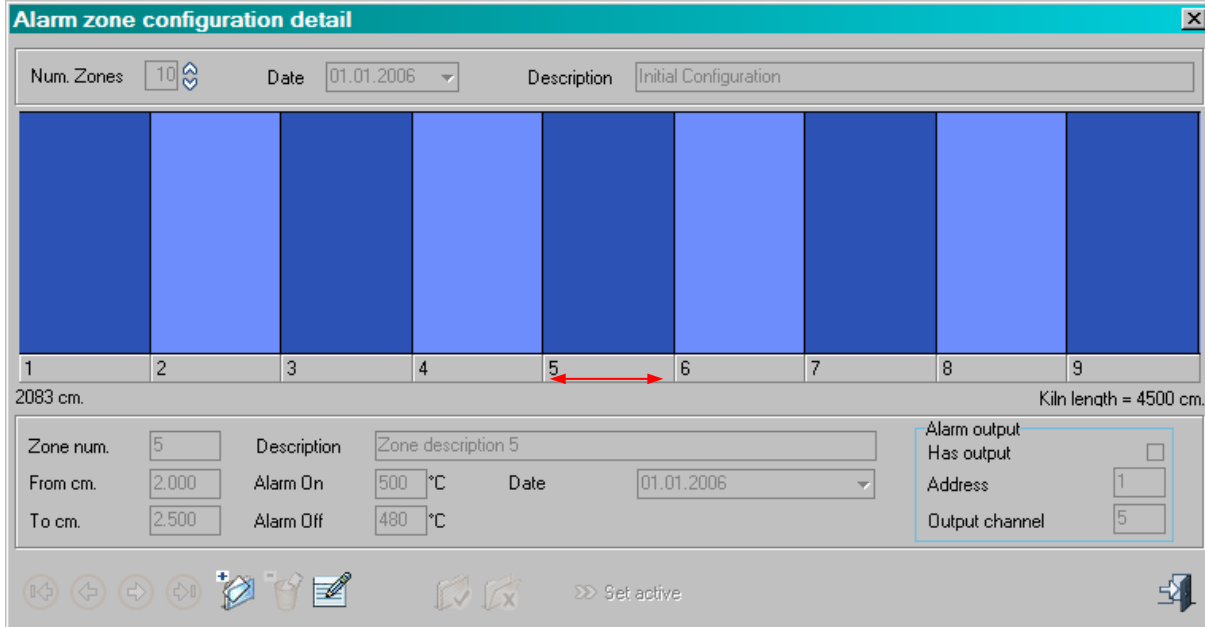

Figure 30: Alarm zone configuration detail

6.2.5.3 Alarm zone definition

This screen defines the beginning and the end of the zone, as well as the alarm limits and a possible digital output in case of alarm. Also provided is additional information such as installation date, a description field and the display colour.

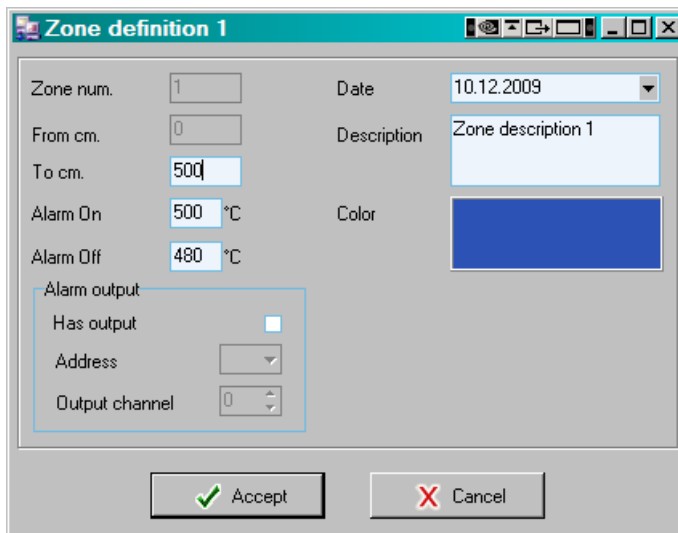

Figure 31: Pyrometer device definition

6.2.6 <Refractory>

6.2.6.1 Repository of refractory configuration

Several different refractory configurations can be established and displayed via this menu option. Obviously, just one of them is the actual active configuration selectable by the <Set active> button.

The buttons along the lower toolbar are used to create new configurations, and also to edit or delete existing ones.

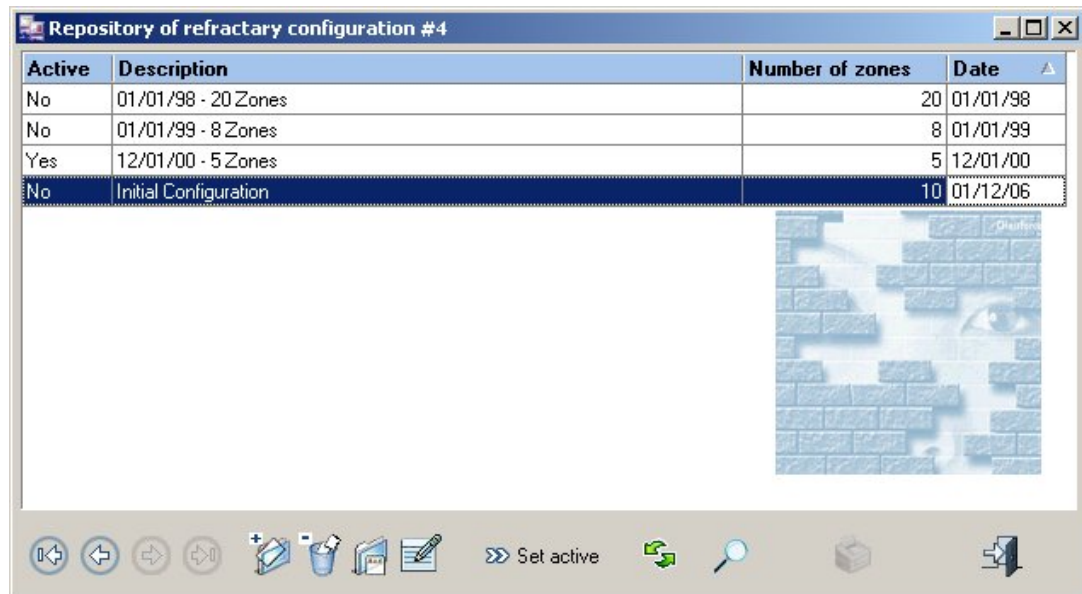

Figure 32: Repository of refractory configuration

6.2.6.2 Refractory configuration detail

Clicking on any refractory configuration will open an refractory configuration detail screen. The refractory zones will be displayed on a mimic diagram along with some basic configuration information along the bottom of the screen. Click on any zone to see more detailed configuration information.

It is possible to adjust the size of a zone directly in that dialog box. To do this, you need to drag the edges of the lower bar (adjacent to the Zone number) corresponding to the zone to be edited.

Configuration

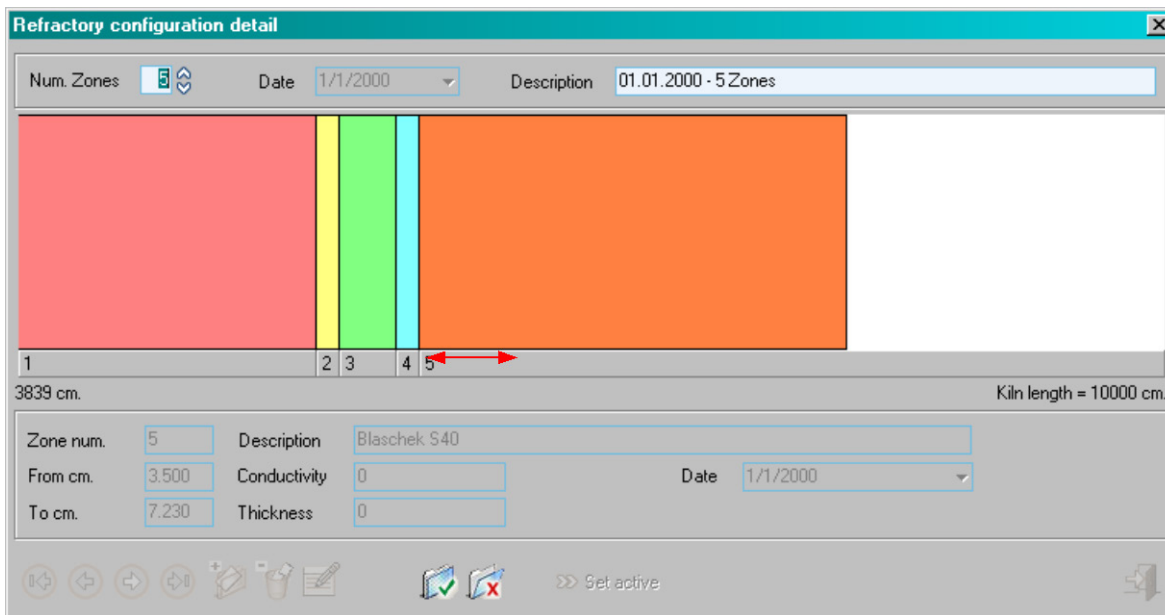

Figure 33: Refractory configuration detail

6.2.6.3 Refractory zone definition

Within that dialog the user can define the beginning and end of each zone, as well as the thermal conductivity and the thickness of the kiln refractory material. Other relevant information such as the installation date, a description field and the display colour can also be entered.

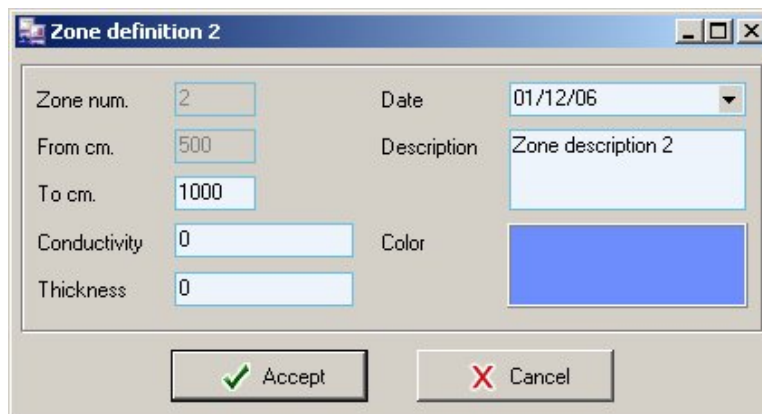

Figure 34: Zone definition detail

6.2.7 <Historical management>

This screen records user preferences in storing historical information.

6.2.7.1 <Images> Tab

There are two different saving types available: the short term history (over days) and the long term history (over months).

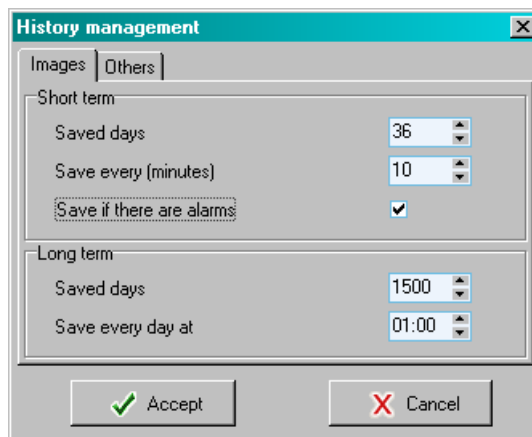

Figure 35: Historical management <Images> Tab

In the example shown in Figure 35, the data storage period in the short term history is limited to 36 days. When recalling historical data, the oldest image that can be restored from the system will be limited to 36 days.

In the same example, the <Save every (minutes)> parameter is set to 10 minutes and therefore, a thermogram will be stored every 10 minutes throughout the 36 day duration. If an alarm condition occurs before the 10 minutes interval is complete, you can force the system to record additionally a thermogram of the alarm condition by checking the <Save if there are alarms> box.

As to the long term history, in the example every day at 01:00 hours, one representative thermogram will be stored based on the average of all thermograms in the short term history for one day. Saving one image per day, and considering the database size limitations, you can save up to 1500 images and therefore 1500 days of history.

6.2.7.2 <Others> Tab

This option allows the user to define the interval of time during which the error and alarm information will be stored. In the example below, the system shown will delete any error or alarm more than 1500 days old.

Configuration

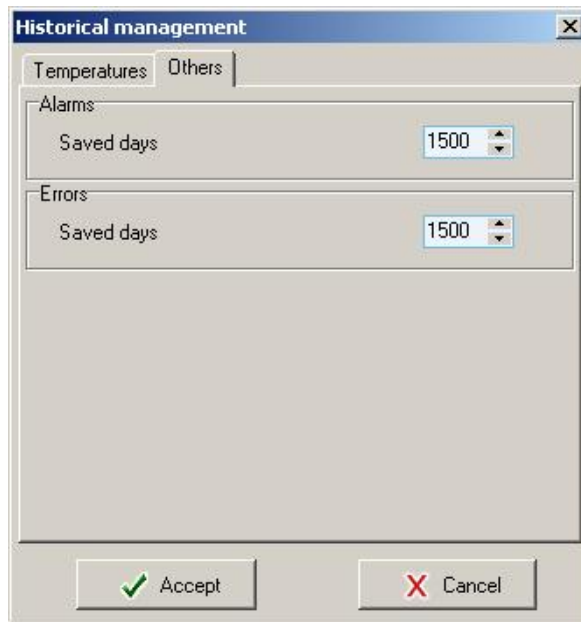

Figure 36: Historical management <Others> tab

6.2.8 <LRM Configuration>

This screen lets you define the features of the LRM system (Live Ring Migration) to correspond with the physical installation. When you first install the software the LRM system is not activated and the only option available is a check box beside the statement <Live Ring Migration system activated>. Once this box is checked, the dialogue screen will be completed with many more opportunities to enter data, as you will see in the figure below.

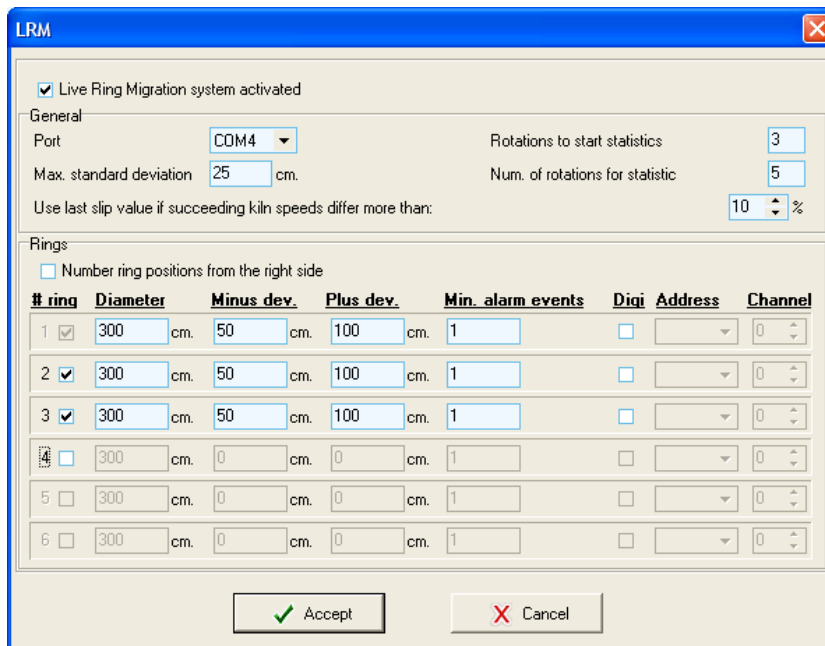

Figure 37: Typical Setting for LRM Configuration

Standard data required includes the COM port, the maximum standard deviation accepted for any ring. In case of violating the <Max. standard deviation>, an LRM alarm is generated.

<Rotations to start statistics> number of kiln rotations to consider before calculating the standard deviation.

<Num. of rotations for statistics> number of kiln rotations to consider when calculating the standard deviation.

<Use last slip value if succeeding kiln speeds differ more than> If the change for the kiln speed from one turn to the next is bigger than the given threshold, not the current but the last valid deviation value for the tyre will be taken.

Within the <Rings> section, the user can define each ring along the length of the kiln, the ring diameter as well as the deviations.



Deviation values will vary from kiln to kiln and also with refractory material. We strongly recommend that you consult the kiln specifications or contact the kiln supplier for more information!

With <Min. alarm events> you can determine the number of consecutive times that a ring must exceed the user-defined limits before an alarm is initiated. For instance, if the value is 1, at the first incident, the system will generate an alarm to warn the user. If the value is 2, the system will not take action after the first incident. If the next revolution also exceeds the limits, then an alarm will be generated indicating that the system is outside control limits.

It is also possible to assign a digital alarm output for each ring. This one output will activate immediately when an alarm is generated and will deactivate once the system returns to a level within the user-defined tolerances and the alarm is cancelled.

6.2.9 <Digital Output Management>

6.2.9.1 Repository of Digital Outputs

This repository shows all digital outputs in the system. The buttons along the lower toolbar let you make new digital output entries, as well as deleting or editing existing entries by inputting the appropriate details.

The same screen also lets you specify the port that the system must use in order to establish communication with the digital output. The communication baud rate will always be 9600.

Configuration

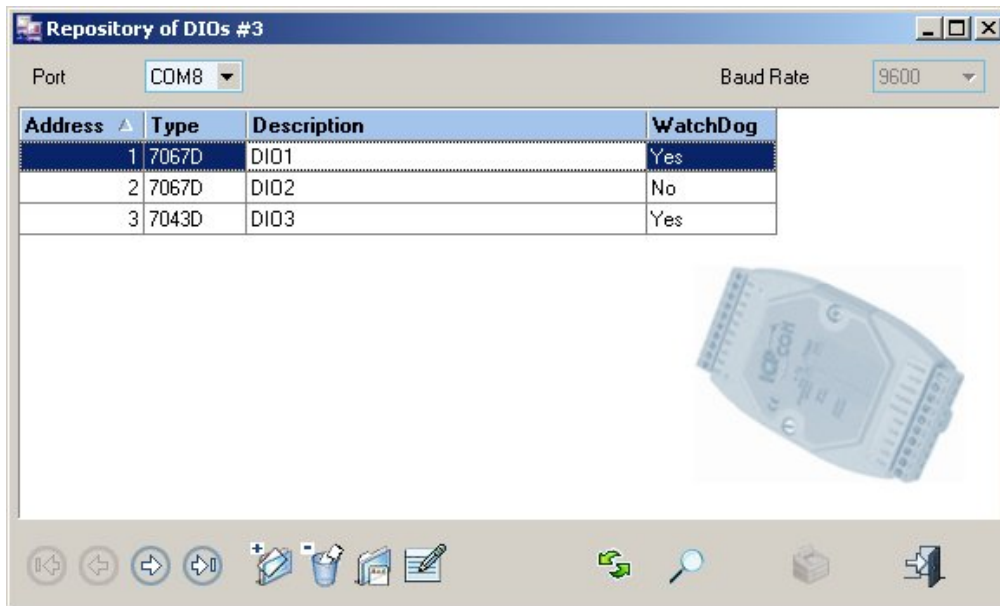

Figure 38: Repository of Digital Outputs

6.2.9.2 Digital Output Management detail

Clicking on any entry will open the detail dialogue box which shows all the possible features for each single digital output: network address, description, type, WatchDog configuration and PowerOn value.

By setting the WatchDog value, the user can define an output value that will be acquired by a digital output when, for whatever reason, it loses contact with ReadScan for a period of time longer than the <Watchdog timeout> which can also be defined by the user. In the given dialog box below, output channel 3 switches from off to on after the <WatchDog timeout>.

The PowerOn value will be the output value that a digital output acquires when starting up.

More technical data for the available output modules are described in appendix see section 13.6 [Output Modules](#), page 119.

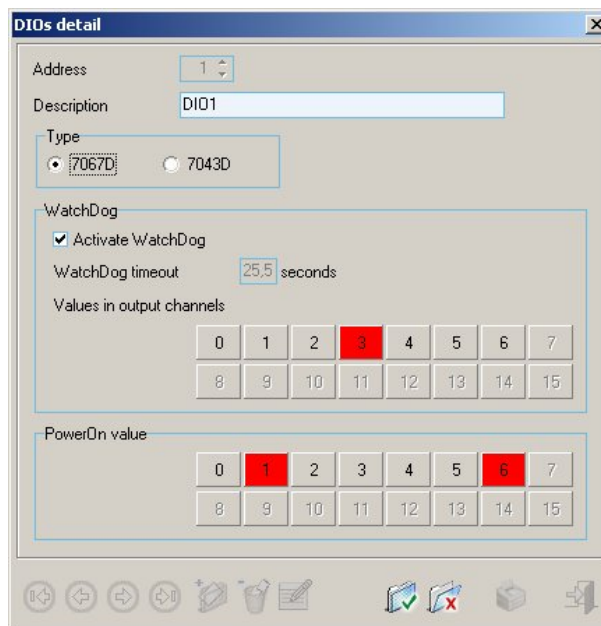

Figure 39: Digital Output Configuration detail



A digital output while assigned to an alarm cannot be deleted!

6.2.10 <Management of Errors>

6.2.10.1 Repository of errors

The following screen shows the errors registered in the system. From this screen, you can see details from each error. Also try thru the option <Error list>, the one shown in the pop-up menu when clicking on the printer icon.

Configuration

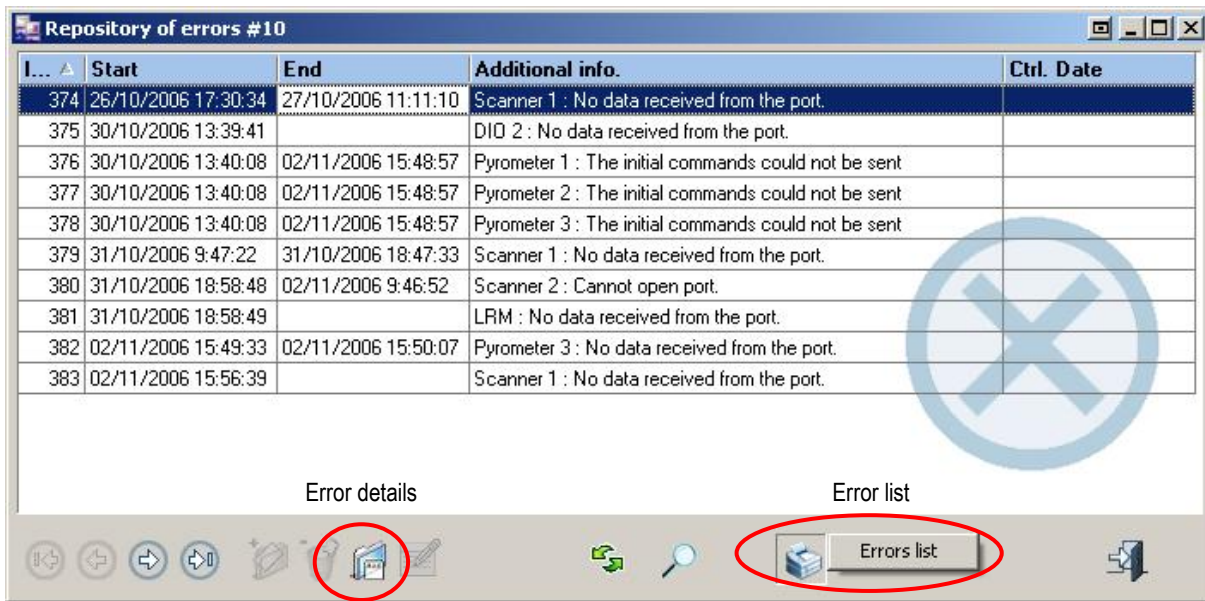

I...	Start	End	Additional info.	Ctrl. Date
374	26/10/2006 17:30:34	27/10/2006 11:11:10	Scanner 1 : No data received from the port.	
375	30/10/2006 13:39:41		DID 2 : No data received from the port.	
376	30/10/2006 13:40:08	02/11/2006 15:48:57	Pyrometer 1 : The initial commands could not be sent	
377	30/10/2006 13:40:08	02/11/2006 15:48:57	Pyrometer 2 : The initial commands could not be sent	
378	30/10/2006 13:40:08	02/11/2006 15:48:57	Pyrometer 3 : The initial commands could not be sent	
379	31/10/2006 9:47:22	31/10/2006 18:47:33	Scanner 1 : No data received from the port.	
380	31/10/2006 18:58:48	02/11/2006 9:46:52	Scanner 2 : Cannot open port.	
381	31/10/2006 18:58:49		LRM : No data received from the port.	
382	02/11/2006 15:49:33	02/11/2006 15:50:07	Pyrometer 3 : No data received from the port.	
383	02/11/2006 15:56:39		Scanner 1 : No data received from the port.	

Figure 40 shows a screenshot of the 'Repository of errors #10' window. The window contains a table with columns: 'I...', 'Start', 'End', 'Additional info.', and 'Ctrl. Date'. The table lists 10 error records (IDs 374-383) with their respective start and end times and descriptions. Below the table, there are two tabs: 'Error details' and 'Error list'. At the bottom, there is a toolbar with several icons. Two icons are circled in red: a document icon with a magnifying glass and a button labeled 'Errors list'.

Figure 40: Repository of errors



It is not possible to add, edit or delete any error from this repository. Errors are periodically and automatically erased based on the settings in the Historical Management under [Others](#) Tab, page 43!

6.2.10.2 Error detail

Clicking the <Look up> button in the <Repository of errors> view will launch the <Error detail> view. In the <Error detail> view you can see all details for each single error: the period of time that the error existed (there's a chance that it's still active), which device experienced the error, a brief comment about the problem and its control status (the user, the date and the comment).

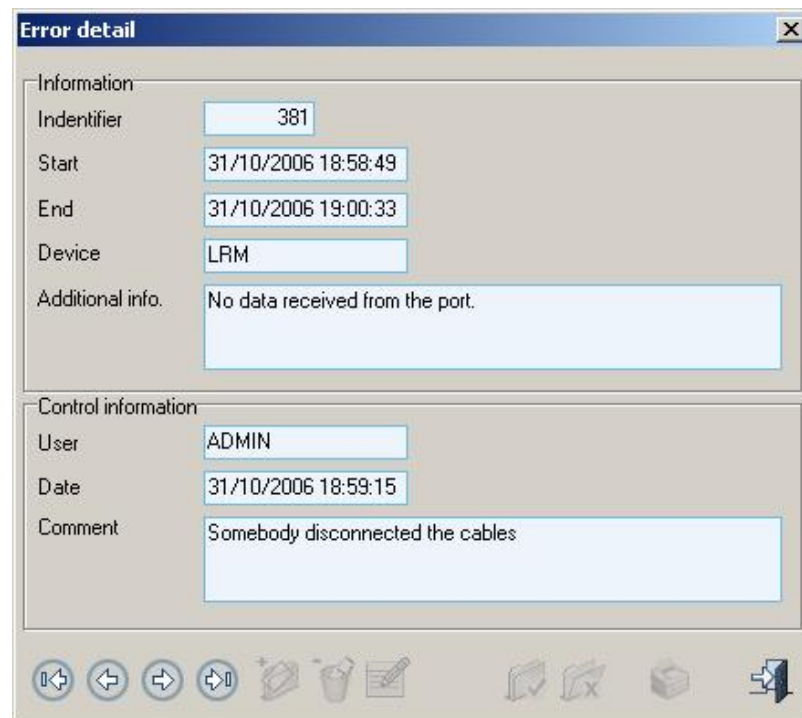

Figure 41: Error detail

6.2.10.3 Error list

Using this screen you can print reports of all errors registered in the system. These lists or reports are fully configurable by using selection filters and sorting criteria.

Selection filters allow filtering information using:

- Error identifier
- Starting date
- Ending date
- State
- Control
- Device

Sorting criteria permits:

- The fields used to sort data.
- The order of each sorted field.

An error list can be filtered via an identifier or by starting and end date. By clicking on the <Export> button you may convert a list into different formats such as pdf, xls, and rtf.

Configuration

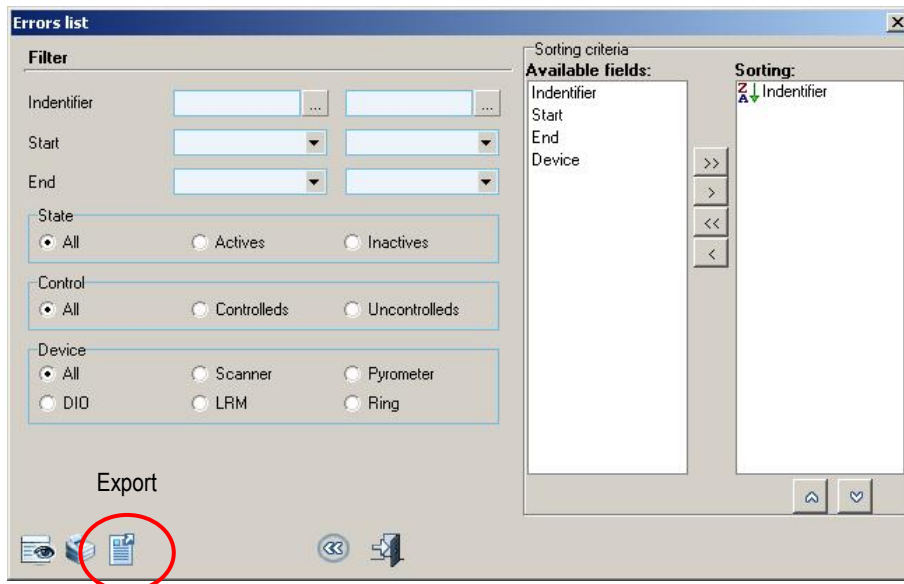

Figure 42: Error list

6.2.11 <Management of Alarms>

6.2.11.1 Repository of alarms

This shows the alarms registered in the system. From this screen, we can display all the alarm details. Similar detail can be displayed by clicking on <Alarms list>, which appears as a pop-up menu when the user clicks on the printer icon.

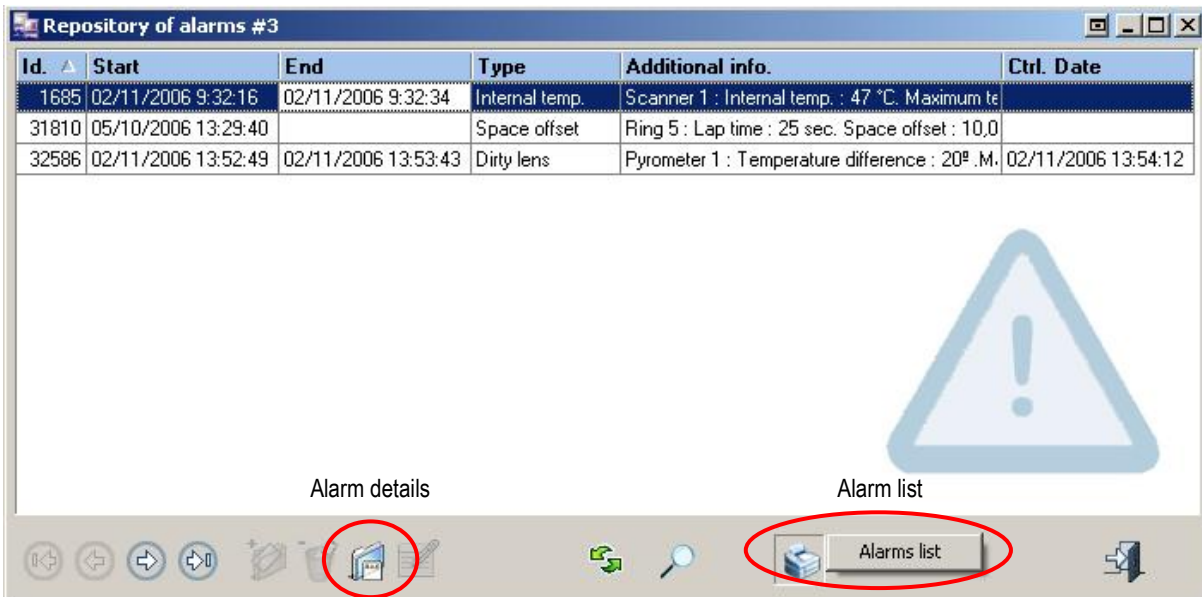

Figure 43: Repository of alarms



It is not possible to add, edit or delete any alarm from this repository. Alarms are periodically and automatically erased based on the settings in the Historical Management under **<Others> Tab**, page 43!

6.2.11.2 Alarms detail

Clicking the **<Look up>** button in the **<Repository of errors>** view will launch the **<Alarm detail>** view. In the **<Alarm detail>** you can see all details for each single alarm: the period of time that the alarm existed (there's a chance that it's still active), which device experienced the alarm, the type of alarm, registered temperature, a brief comment about the problem and its control status (the user, the date and the comment).

Information	
Identifier	1685
Start	02/11/2006 9:32:16
End	02/11/2006 9:32:34
Device	Scanner 1
Temperature	47 °C
Type	Internal temp.
Additional info.	Maximum temp. : 45 °C

Control information	
User	
Date	
Comment	

Figure 44: Alarms detail

6.2.11.3 Alarms list

Using this screen you can print reports of all alarms registered in the system. These lists or reports are fully configurable by using selection filters and sorting criteria.

Selection filters allow filtering information using:

- Alarm identifier
- Starting date
- Ending date
- State
- Control

Configuration

- Alarm type
- Device

Sorting criteria permits:

- The fields used to sort data.
- The order of each sorted field.

An alarm list can be filtered via an identifier or by starting and end date. By clicking on the <Export> button you may convert a list into different formats such as pdf, xls, and rtf.

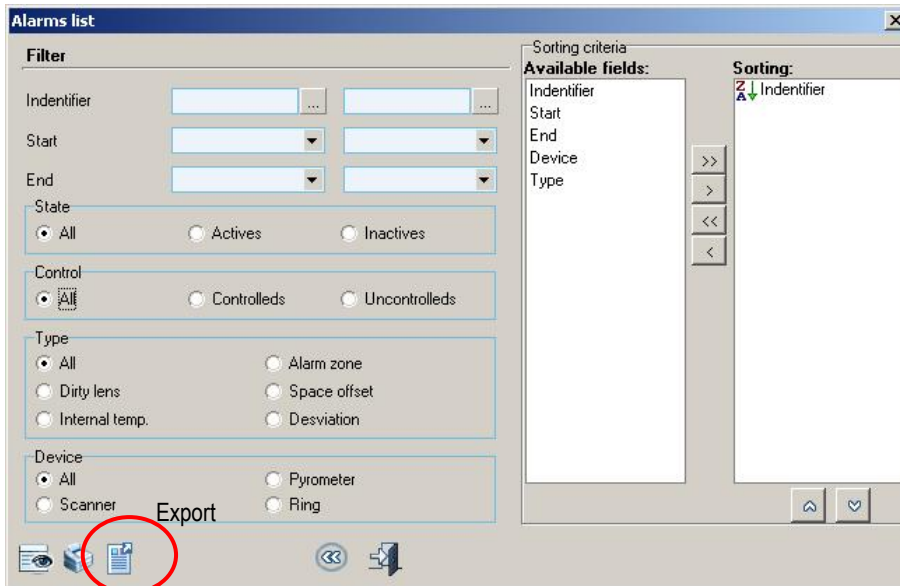

Figure 45: Alarms list

6.2.12 <Users>

The repository of users is accessible via the menu <Utilities> <Users>.

The user's management allows the entry of new users, as well as the modification and deletion of existent ones. Each user can be assigned an appropriate security level to maintain system integrity.

6.2.12.1 Users Repository

This window shows all users currently registered in the system. There is always one default user, with the preset user code of 'ADMIN' and no password.



The screenshot shows a window titled "Repository of users #2" with a table containing the following data:

User code	User name	Register date	Telephone
ADMIN	Administrator	01/01/2006	
JOSEPH	Joseph Collins	30/10/2006 13:35:00	972 254 382

Below the table is the Raytek logo and a toolbar with various icons for navigation and actions.

Figure 46: Repository of users



The user ADMIN cannot be deleted under any circumstance!

6.2.12.2 User's detail

Clicking on the user name will open the detail screen that will display detailed information for each user that the system has registered. There are the main tabs <General>, <Permission>, and <Others>.

6.2.12.2.1 <General> Tab

This tab contains personal information, such as name and password, e-mail address, telephone number, cell phone and fax.

Configuration

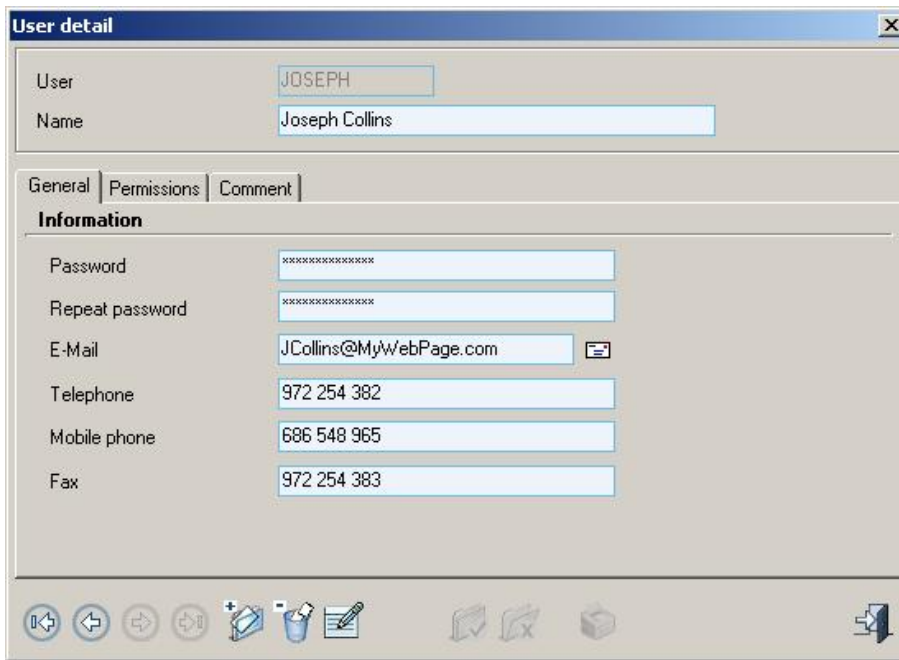

Figure 47: User detail: <General> Tab

6.2.12.2.2 <Permissions> Tab

Within this detail, you can display and edit each user's permissions, or in other terms their access to the system. These permissions set individual access restrictions for each user for several system components like Config, DBCheck, Deneb, and ReadScan.

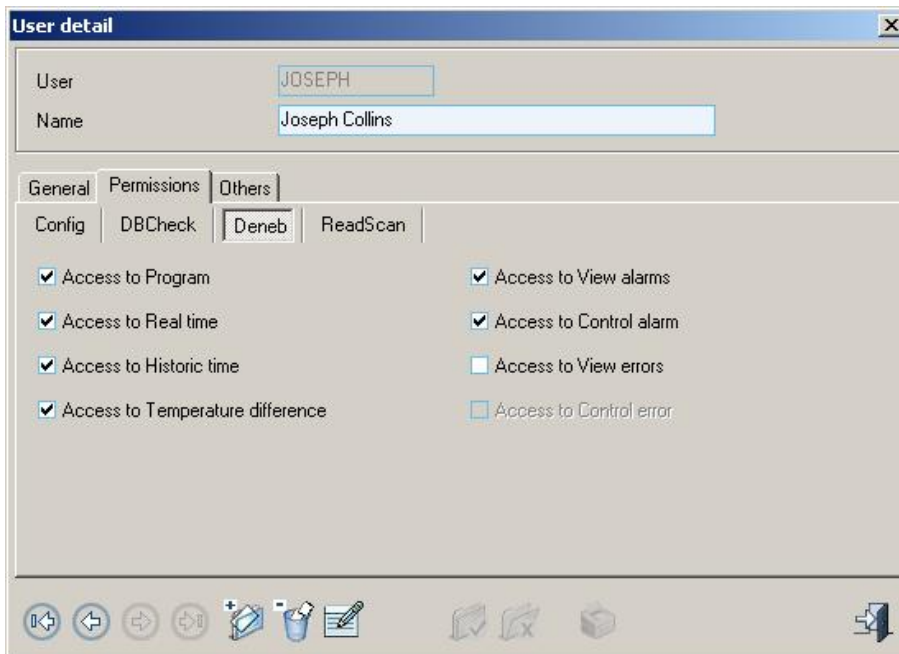

Figure 48: User detail: <Permissions> Tab



Permissions for user ADMIN cannot be edited!

6.2.12.2.3 <Others> Tab

Under <Deneb> the users can define their personal preferences in regard to system audible alarms.

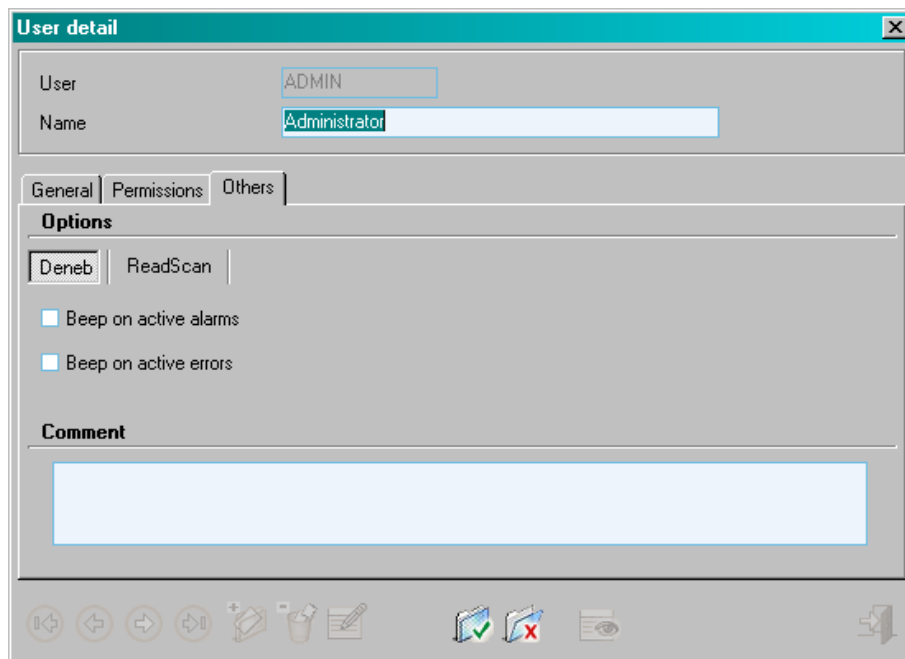

Figure 49: User detail: <Others> Tab

Under <ReadScan> the users can activate the check box to send emails in case of alarms.

Configuration

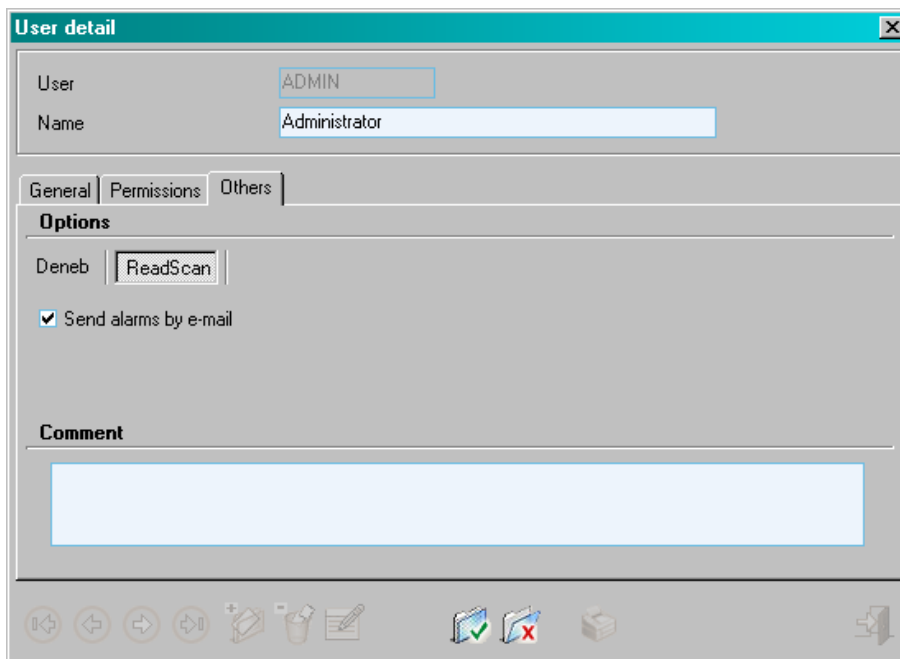

Figure 50: User detail: <Others> Tab



Some options may be disabled since they rely upon the user's permissions!

6.2.13 <Update ReadScan>

If Configuration values change the ReadScan program must be restarted. You can find <Update ReadScan> under <Utilities> of the CS Config.

7. Operation

The system is designed in a client-server structure. That is, ReadScan works as the server while Deneb works as the client.

Therefore, ReadScan runs the main system tasks, such as communicating with the serial devices, interpreting the incoming information, and interfacing with the digital output modules. Its other important task is serving the Deneb's clients.

Deneb's clients are, in essence, 'voyeurs' of the system. Their main duties are displaying the physical state of the different system devices, as well as recovering historical data from the system. Furthermore, they permit the user to control the events (alarms and errors) that can show up in the system.

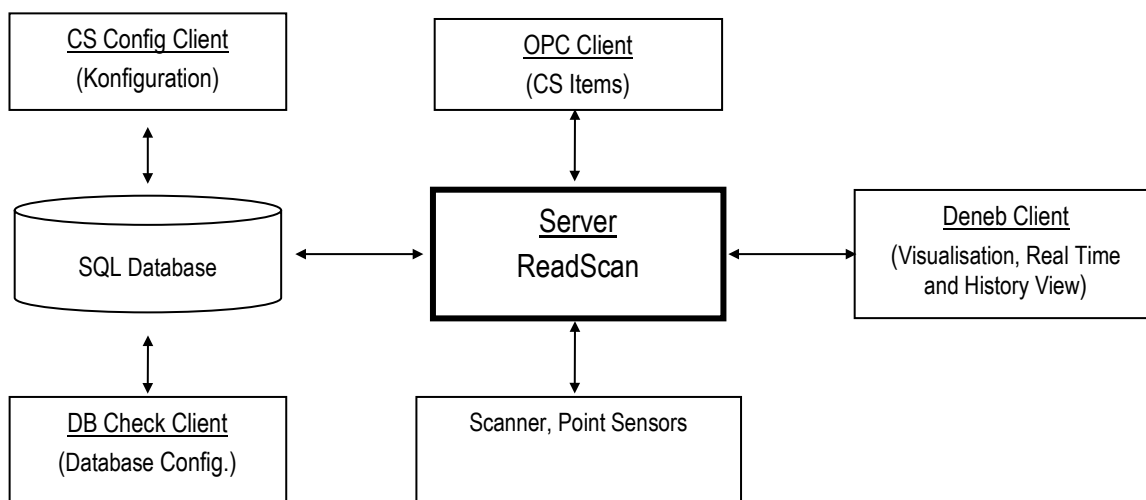

Figure 51: Principal Software Structure

7.1 ReadScan

Launching:

In accordance to the pre-settings in the installation (see [Figure 13](#), page 27), ReadScan will appear automatically when your computer is started. Otherwise, to run ReadScan you must click on its icon, located in the program group CS.

Closing:

There are two reasons to close ReadScan: 1) reinstalling or updating the CS software and 2) freeing an occupied COM port for use by another scanning software. Be aware that ReadScan does not close by clicking on the windows <Exit> button – The Close button removes the CS Readscan screen from the desktop, but does NOT stop the service! To close CS Readscan, right-click on the small Readscan icon on the tray and select the menu entry <Close>!



Figure 52: Closing of ReadScan via the task bar

Operation

7.1.1 <Control> Tab

On this tab you will find the commands needed to start and stop the service without closing the ReadScan application. This function is particularly useful when the user needs to restart ReadScan to fully implement any changes set by CS Config.

It also shows the number of laps registered by the system from the service start up, the rotation velocity, the time duration of the last lap, the exact time that the record was updated and the memory occupied by the program. Except for the occupied memory, which is updated once per second, the rest of the information refreshes after the completion of rotation of the kiln.

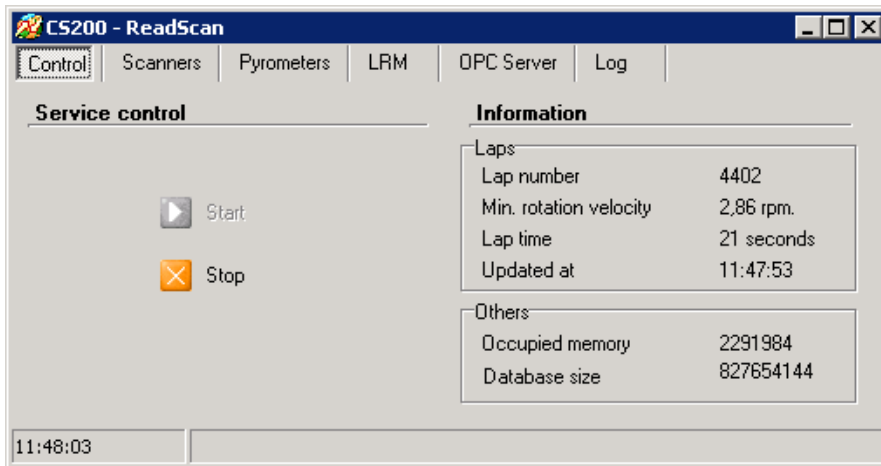

Figure 53: Main screen: <Control> Tab



Remember that to ensure that changes are acknowledged, ReadScan has to be restarted each time configuration changes are made!

Running the software without having a valid license installed (e.g. for demonstration purposes) sets the software to the unregistered mode with the following restrictions:

- A maximum of 10 images can be stored in the database.
- The thermal image shows 10% of the lines without temperature data.

7.1.2 <Scanners> Tab

This tab shows information on the scanners configured to work with the system. If Scanner 2 is not being used, the right side of the window will be blank.

In normal circumstances, the information shown becomes updated at the end of each kiln rotation. If communication is interrupted the information will be updated as soon as detection takes place.

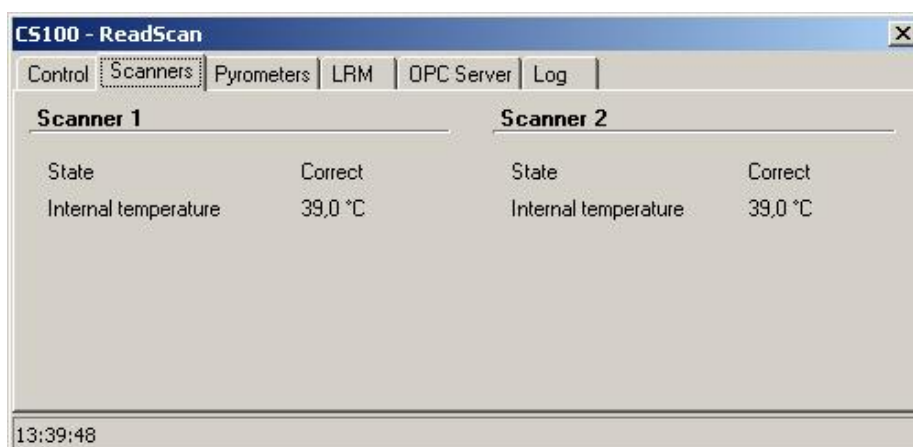

Figure 54: Main screen: <Scanners> Tab

7.1.3 <Pyrometers> Tab

This tab shows information on the pyrometers configured to work with the system. If no pyrometer is configured, the user will be informed about that.

In normal circumstances, the information shown becomes updated at the end of each kiln rotation. If communication is interrupted the information will be updated as soon as detection takes place.

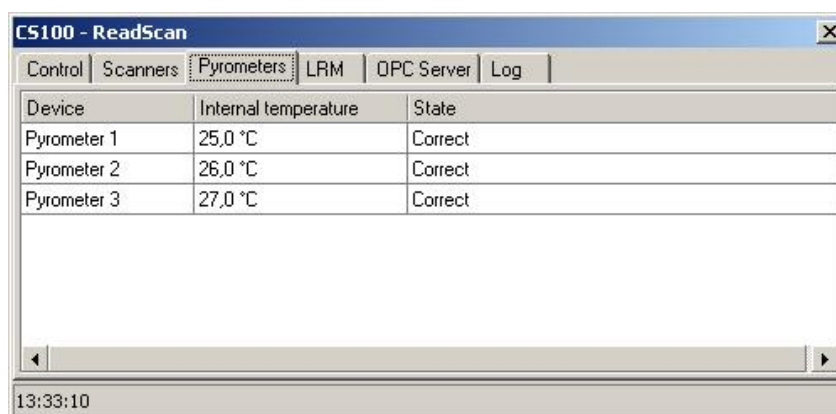

Figure 55: Main screen: <Pyrometers> Tab

7.1.4 <LRM> Tab

This tab shows information related to the LRM system (Live Ring Migration). If this system is not operational, the user will be informed about that.

In normal circumstances, the information will be updated when new data is received from the system. However, it will not be possible to report about ring slip until the kiln has finished its current lap. If communication is interrupted the information will be updated as soon as detection takes place.

Operation

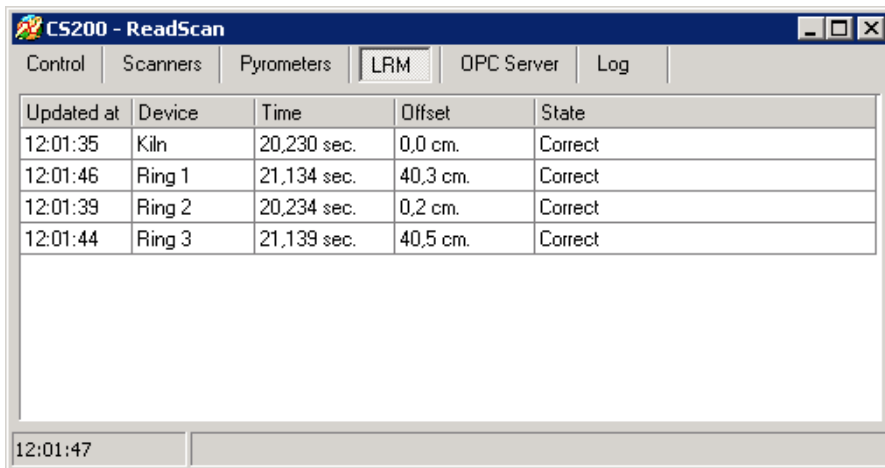

Figure 56: Main screen: <LRM> Tab

7.1.5 <OPC Server> Tab

This tab shows information related to the OPC Server utilized by ReadScan. To make the OPC server active, you have to check the <OPC server active> check box in CS Config, see section 6.2.1.2 <Communications settings> Tab, page 29. Under this section you can also find a list of available OPC items.

The <Disconnect clients> button forces the disconnection of all the OPC clients connected.

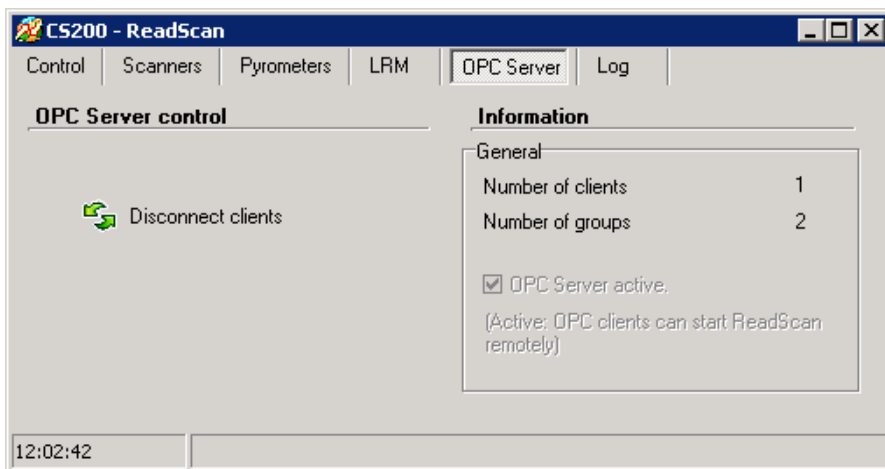

Figure 57: Main screen: <OPC Server> Tab

7.1.6 <Log> Tab

By clicking on this tab the user can see a summary of the actions taken by ReadScan: the commands sent to every device and a log showing both correct operation and any errors or alarms. It also gives out information about every image that the system chooses to save.

Clicking the right mouse button activates a pop-up menu, which lets you, copy, print, save and delete all of the information displayed.

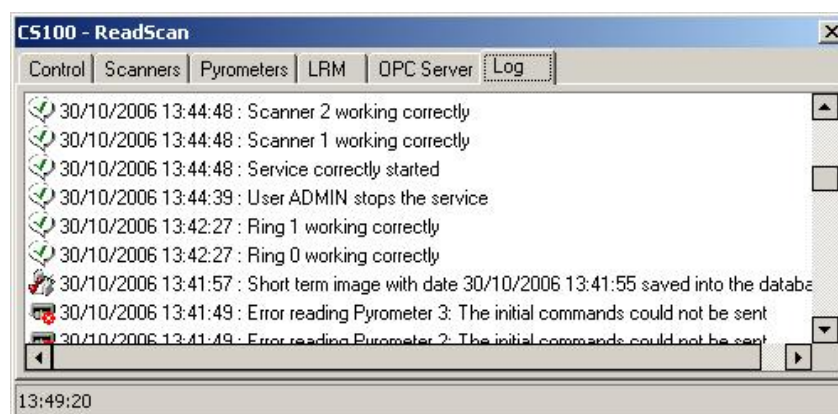

Figure 58: Main screen: <Log> Tab

7.2 CS Runtime Software: Deneb

To run Deneb you must click on its icon, located on the desktop or in the program group CS.

7.2.1 <Main> <Real time>

This screen shows the temperature status of the kiln's surface in real time. There are three main components to this screen: temperature chart, thermogram and lower status bar.

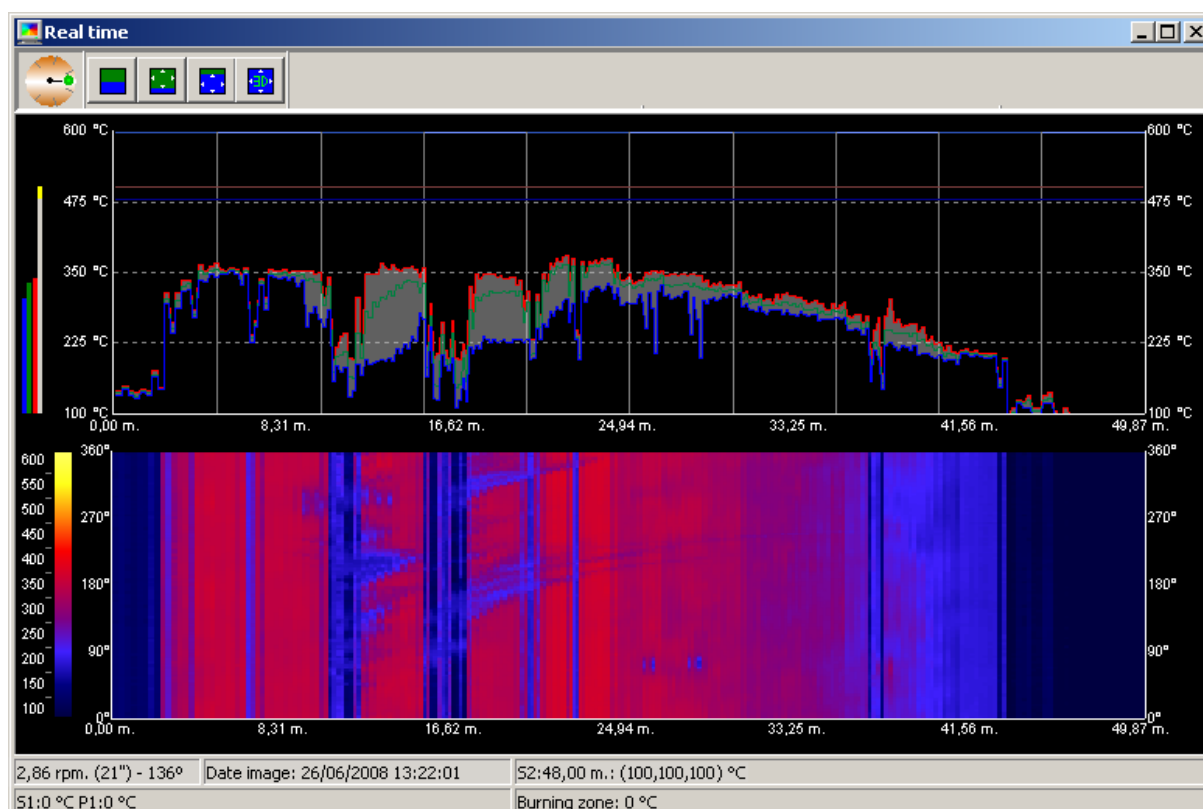

Figure 59: Real time screen

The temperature chart is located in the upper screen area. This chart provides a plot of the kiln surface temperature with three data sets representing maximum, minimum and average temperatures at each

Operation

data point along the length of the kiln. Overlaid on this image are the user-defined refractory zones and alarm zones (with maximum limits) Highlighted in red color are those alarm areas where there is any active alarm caused by too hot temperatures.

The thermogram takes up the most of the lower screen area, providing the temperature distribution across the kiln surface represented by a false-colour image.

In the context menu (right mouse click) of the <Real Time> view you can access the <Set as reference> item which defines the current thermal image as a reference image. A reference image will be used for calculating difference images, see section 7.2.13 <Graphic> <Difference between images>, page 75.

In the same context menu you can access the <Advanced configuration> item. It allows the user to select between different display options: background and axis colours, alarm and refractory zones, profile lines (formats, colour and thickness) and configuration of area series (limits, colour and transparency).

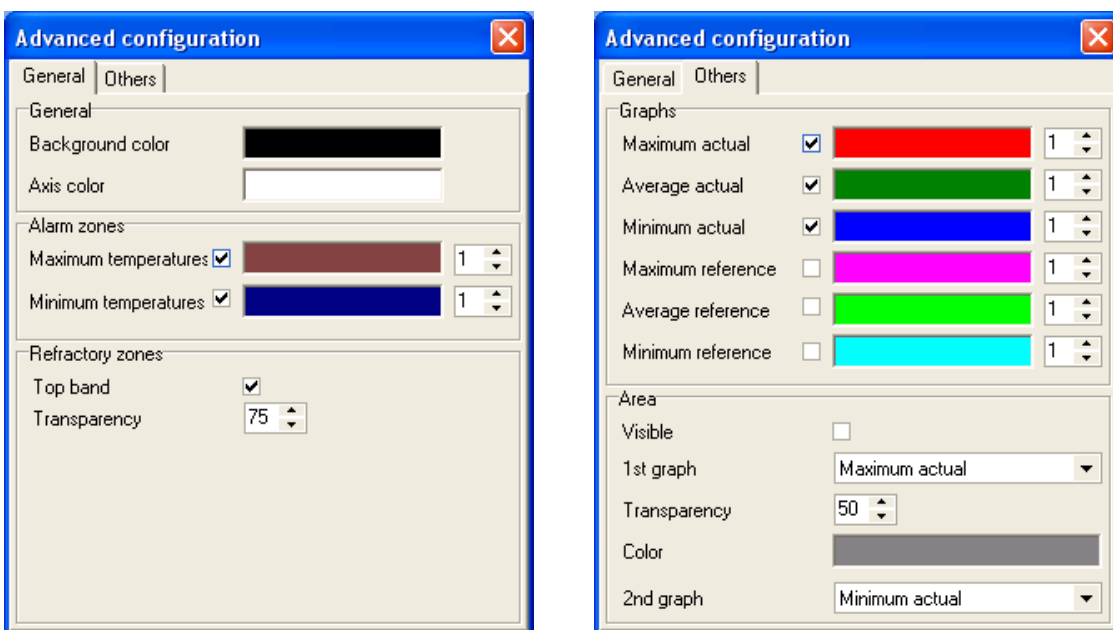

Figure 60: Advanced configuration for the Real Time view

The lower status bar makes it possible to see other useful information without the need to open other windows. The range of information shown is:

- Time taken to complete the displayed lap
- Time lapsed since the lap was displayed
- Location and temperature at the cursor location in the current thermogram
- Internal temperatures of the temperature sensors (Scanners and pyrometers)
- Burning zone temperature

Also, in the upper part of the screen, there're some icons that permit you to:

- Display only the profile chart
- Display only the thermogram
- Display both (default option)
- 3D view for the thermogram



The display is updated every time the kiln completes a lap!



Both in the chart and the thermogram, you can zoom into a specific area of the kiln. To do so, click and drag from left to right, creating a square surrounding the area of interest!

Operation

7.2.2 <Main> <Historic time> <Short term>

This screen is very similar to the Real-time screen described above (described in section 7.2.1 <Main> <Real time>, page 61), and allows the user to view historical images stored by the system in the short-term database. Next to the image, related information such as LRM information and active alarms during the image are displayed in separate windows.

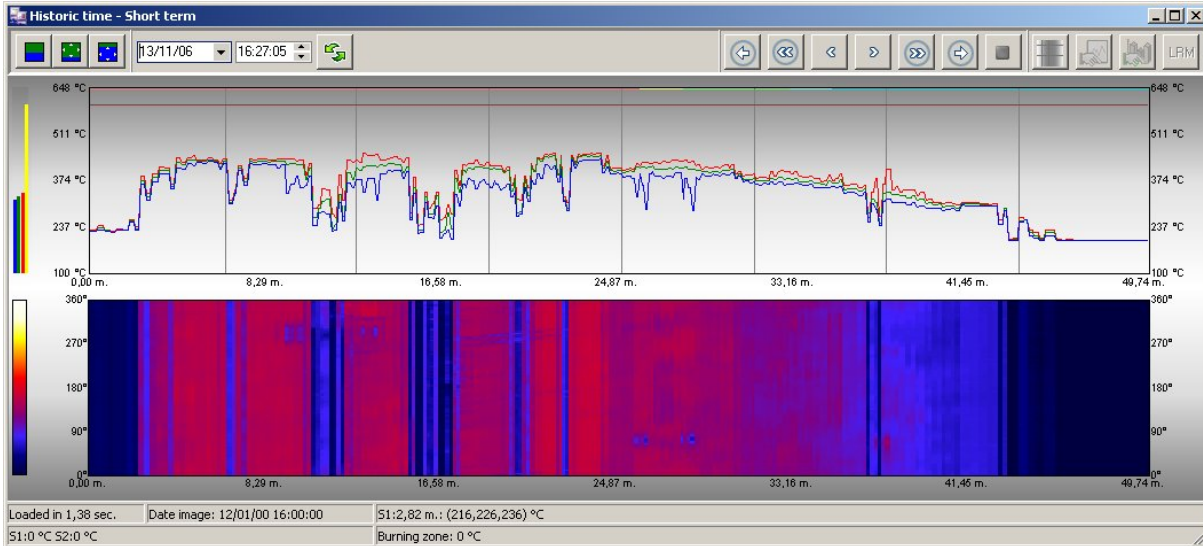



Figure 61: Short term - Historic time screen

The upper buttons helps to navigate thru all the images stored in the system:

- Navigate one by one (a new image with every click) or play the images in sequence.
- Navigate forward (from oldest to newest) or navigate backwards (from newest to oldest) in self-running mode

For direct accessing the Histogram charts and Tendency chart (described in sections 7.2.11 <Graphic> <Histogram>, page 73 and 7.2.12 <Graphic> <Trend>, page 74) you have to exit the zoom mode by clicking on the <Go to mode Marking> icon , and activating two more icons in which provide access to the Histogram and Tendency charts.

The Marking mode allows the user to define the kiln area to be studied in the charts and the user may select the entire kiln or just one area. To select a specific area of the kiln, click on the starting point of the desired area and click on the point where you want the area to finish. The status bar provides information on the area selected, and by moving the border the size can be easily edited.

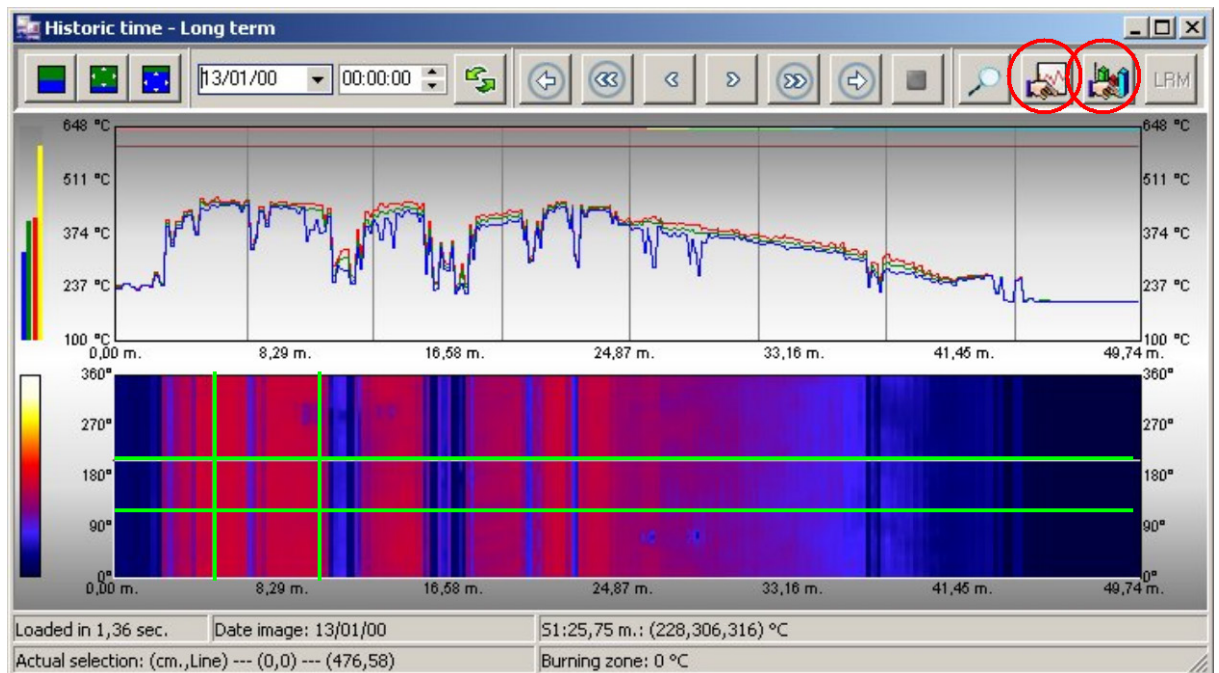

Figure 62: Short term - Historic time screen in Marking mode

Once the area is selected just click on the corresponding chart icon to display the desired information. The data will be displayed, and the length and lines of the chart options will adjust automatically. To exit the Marking mode and come back to zoom mode, just click on the <Go to mode Zoom> icon.

Operation

7.2.3 <Main> <Historic time> <Long term>

This screen is very similar to the short-term screen described above with the main exception being that the images in this case correspond to the long-term period based on days.

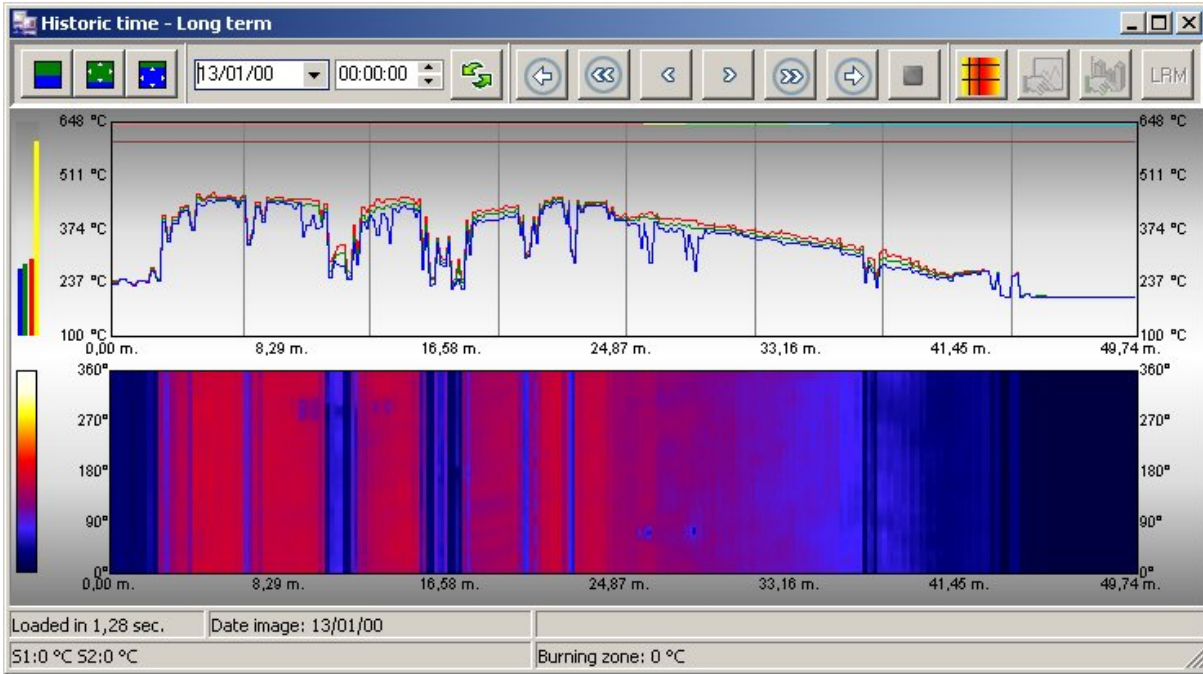

Figure 63: Long term - Historic time screen in zoom mode

7.2.4 <Main> <Reference image>

This item is active once the user has defined one image as a reference image. To mark an image as a reference image, you have to launch the context menu <Set as reference> in the <Real Time> view, see section 7.2.1 <Main> <Real time>, page 61. Alternatively, you can define a reference image also via the historical view. One image only can be set to the reference image.

7.2.5 <Secondary> <Internal temperatures>

This screen shows the internal temperature of scanners and pyrometers. The data is recorded at the point of completion of the lap currently being displayed. It will be refreshed after each kiln lap.

Internal temperatures	
Device	Internal temperature
Scanner 1	20,0 °C
Pyrometer 1	26,0 °C
Pyrometer 2	26,0 °C
Pyrometer 3	28,0 °C

Figure 64: Internal temperatures screen



An unrealistic temperature display of e.g. 0° C may be a sign of a communication error!

7.2.6 <Secondary> <Burning zone graphic>

This screen shows the temperature measured by the burning zone sensor. The data is recorded at the point of completion of the lap currently being displayed. It will be refreshed after each kiln lap.

Apart from the numerical display, there is a chart that allows the user to visualize the temperature trend over time.

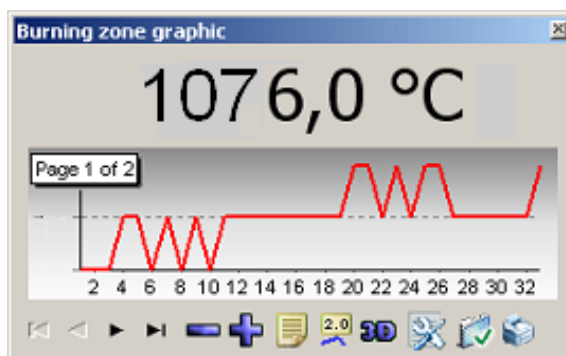

Figure 65: Burning zone chart



An unrealistic temperature display of e.g. 0° C may often be a sign of a communication error with the pyrometer or an indication of an improperly configured pyrometer. Make sure that the pyrometer is correctly identified as a burning zone pyrometer!

7.2.7 <Secondary> <LRM view>

The LRM detail screen graphically represents the LRM information associated with the current lap. This information comprises of the time to complete the current lap, the time for each ring to complete that lap, and the rotational deviation or offset of each tire relative to the driven tire.

The screen has several tabs explained below.

7.2.7.1 <Kiln view> Tab

This screen shows a graphical representation of the kiln with the lap time for each ring to complete the current lap, and the offset (slip) relative to the driven tire.

Operation

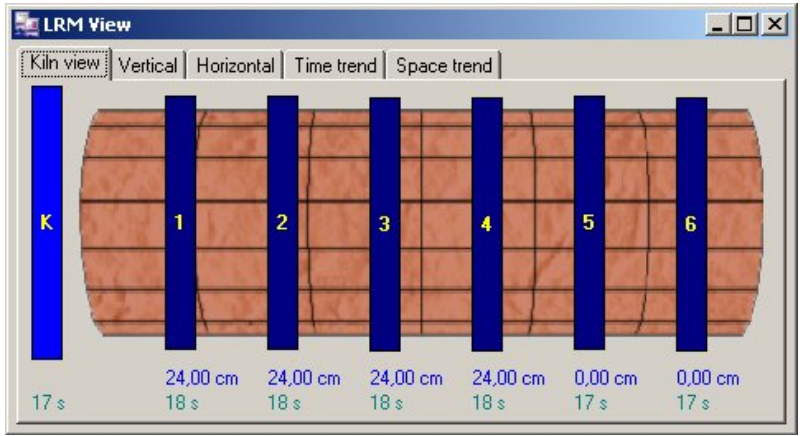

Figure 66: <Kiln view> Tab of the LRM view

7.2.7.2 <Vertical> Tab

This tab shows, on a vertical bar chart, the time duration for each ring to complete the current lap, and the offset relative to the driven tire. Right clicking on the chart will launch a pop-up menu allowing the user to toggle between time and offset or to display both simultaneously.

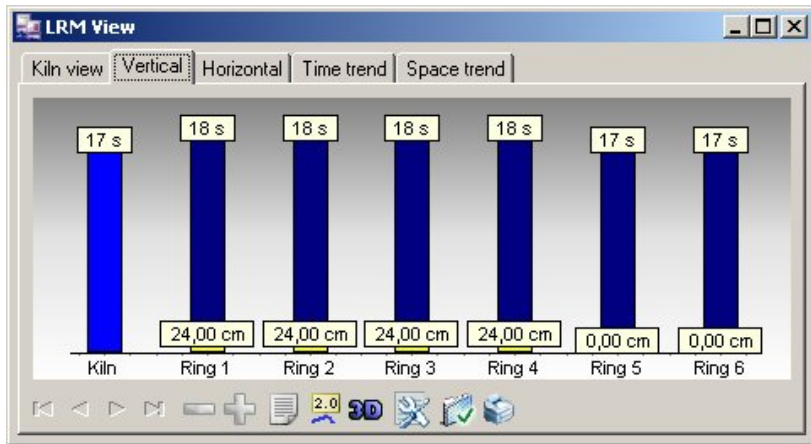

Figure 67: <Vertical> Tab of the LRM view

7.2.7.3 <Horizontal> Tab

Almost identical to the screen described above (section 7.2.7.2 <Vertical> Tab), this chart is rotated by 90°.

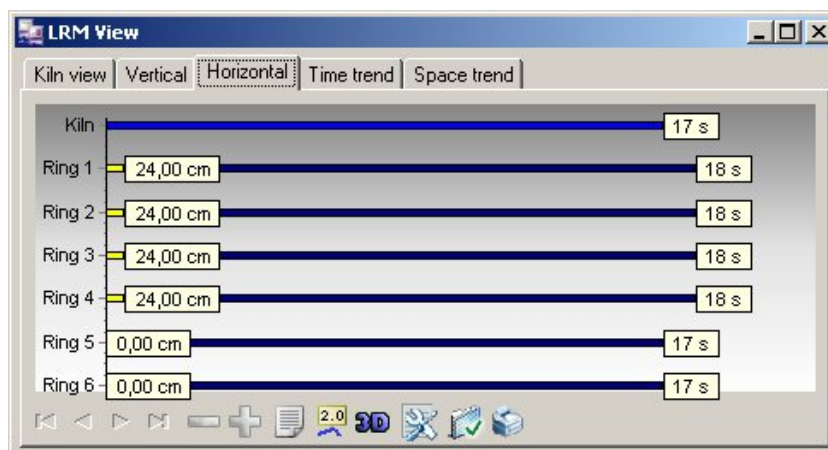

Figure 68: <Horizontal> Tab of LRM view (info about the slip)

7.2.7.4 <Time trend> Tab

This tab displays a line chart of the lap duration for each tire over a number of rotations. This allows the user to visualize the evolution of the timing and easily compare the data for each tire.

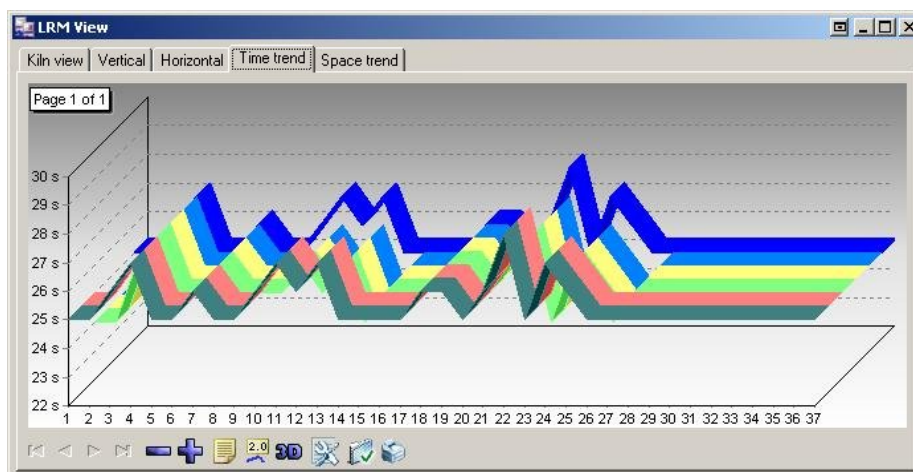

Figure 69: <Time trend> Tab of LRM view

7.2.7.5 <Space trend> Tab

This one tab displays the offset for each tire (slip) on a line chart allowing the operator to see the evolution of such offsets and easily compare the data for each tire.

Operation

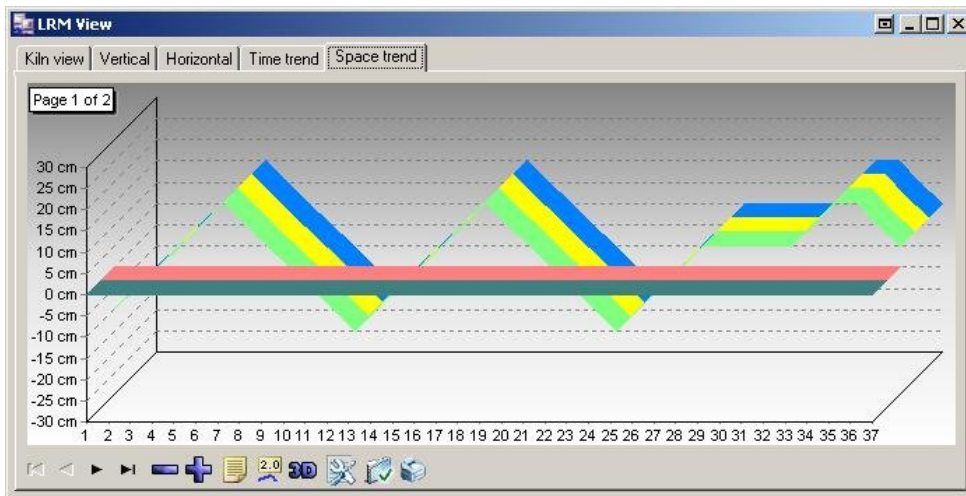

Figure 70: <Space trend> Tab of LRM view



In normal operation the data on all tabs explained above is updated in real-time. However, the offset data cannot be updated until the corresponding revolution of the kiln has been completed!

7.2.8 <Special zones>

In the <Real time> view one can place a dedicated window called <Special zones> to monitor a specific area of the thermal image.

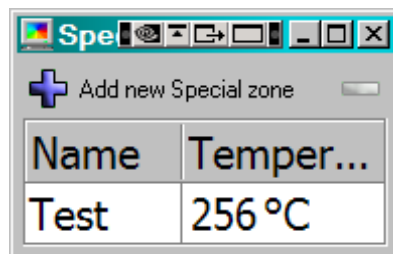

Figure 71: <Special zones> Window

7.2.9 <Secondary> <Errors>

The <Errors> screen shows all errors recorded by the system with the following features:

- The error is still active and not controlled (RED)
- The error is still active but controlled by the user (YELLOW)
- The error is not active anymore (GREY)

Id.	Start	End	Device	Additional info.	Ctrl. Date	Ctrl. User	Ctrl. Comment
396	13/11/2006 16:28	13/11/2006 16:29	Scanner 1	No data received from the port.			
395	13/11/2006 16:27		DIO 2	No data received from the port.			
394	13/11/2006 16:27		DIO 1	No data received from the port.			
393	13/11/2006 16:23		Pyrometer 3	No data received from the port.	13/11/2006	ADMIN	Pyrometer is disconnected

Figure 72: Errors' screen

Control of an error is made via the <Controlling error> option, shown in the error's pop-up menu or by double clicking on the error itself.

Insert comment - Error 392

Control comment

Accept Cancel

Figure 73: Control screen and comments



Errors that are no longer active will be deleted from the system as soon as ReadScan confirms that a user has taken action to control the error!



In the CS Config, see section 6.2.12.2.3 <Others> Tab, the user can configure the system to "beep" while errors are active!

7.2.10 <Secondary> <Alarms>

This screen is basically the same just explained above in the section 7.2.8 <Special zones>, page 70. The only difference being that the information shown in this case is about alarms instead of errors.

Operation

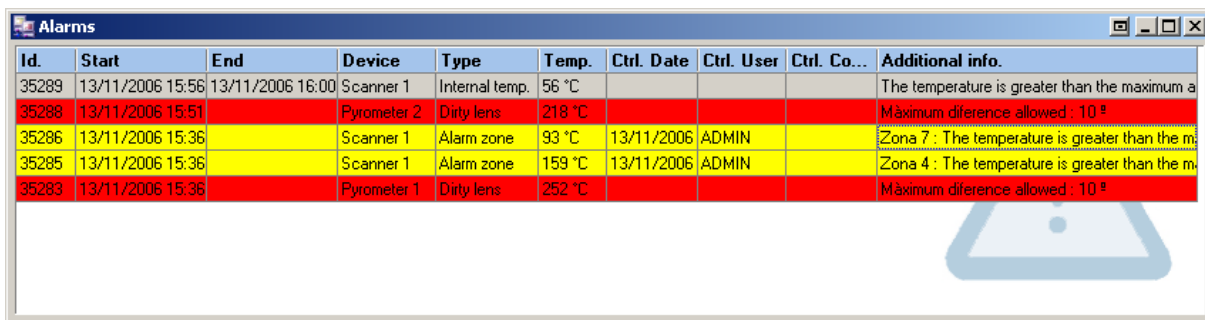

The screenshot shows a window titled "Alarms" with a table of alarm events. The table has columns for Id., Start, End, Device, Type, Temp., Ctrl. Date, Ctrl. User, Ctrl. Co..., and Additional info. The rows are color-coded: red for "Dirty lens" and yellow for "Alarm zone".

Id.	Start	End	Device	Type	Temp.	Ctrl. Date	Ctrl. User	Ctrl. Co...	Additional info.
35289	13/11/2006 15:56	13/11/2006 16:00	Scanner 1	Internal temp.	56 °C				The temperature is greater than the maximum a
35288	13/11/2006 15:51		Pyrometer 2	Dirty lens	218 °C				Maximum diference allowed : 10 °
35286	13/11/2006 15:36		Scanner 1	Alarm zone	93 °C	13/11/2006	ADMIN		Zona 7 : The temperature is greater than the m
35285	13/11/2006 15:36		Scanner 1	Alarm zone	159 °C	13/11/2006	ADMIN		Zona 4 : The temperature is greater than the m
35283	13/11/2006 15:36		Pyrometer 1	Dirty lens	252 °C				Maximum diference allowed : 10 °

Figure 74: Alarms' screen

7.2.11 <Graphic> <Histogram>

Within the <Graphics> drop-down menu the operator can select the histogram view.

A histogram is a bar chart where the “x” axis represents the temperatures and the “y” axis represents the corresponding pixel count.

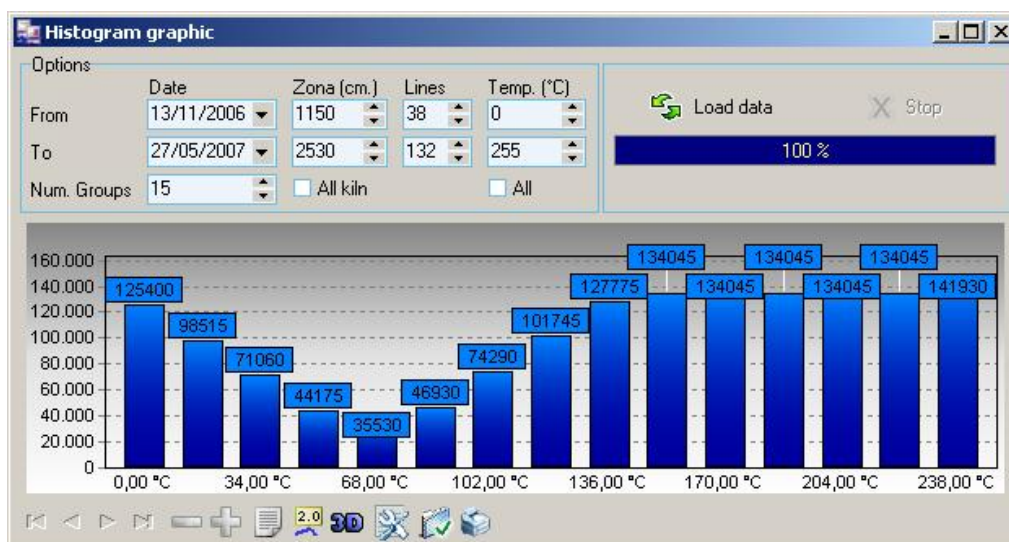

Figure 75: Histogram chart

On this screen the user can define:

- the time period of interest, (from X date to Y date),
- the particular zone of interest along the length of the kiln (start point at X cm, end point at Y cm)
- the particular lines of interest over the kiln rotation
- the temperature range to be reported
- number of groups to display the temperature data

Once the values are established, the <Load data> button starts the data loading process. Depending on the values shown, the loading process may take long time, so a progress bar indicates the approximated percentage of the process done. Activating the <Stop> button will stop the data-loading process.



The area to be studied can be graphically selected in the ‘real time view’, as described in section 7.2.1 <Main> <Real time>, page 61!

Operation

7.2.12 <Graphic> <Trend>

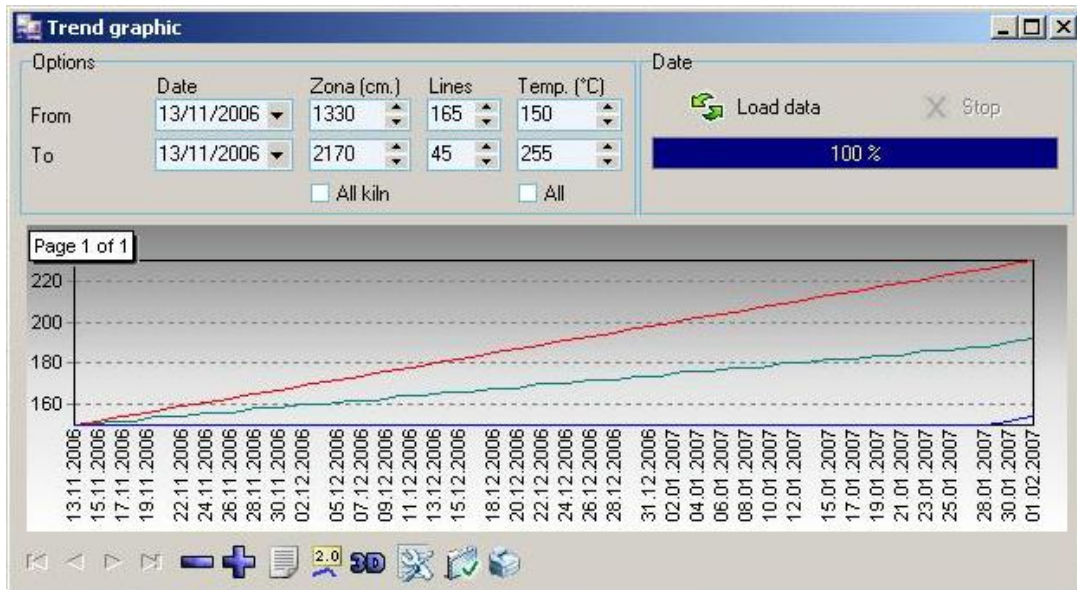

Figure 76: <Graphic trend> screen

This chart displays the same data as the histogram but in a line chart format. The lines are colour coded showing maximum temperature (red), average temperature (green) and minimum temperature (blue). As before the area of interest, time period of interest and temperature are all user defined.

7.2.13 <Graphic> <Difference between images>

This screen permits the operator to directly compare data from two unique time periods. Simply define the start points of the two periods and click on the <Load Images> button to display the data.

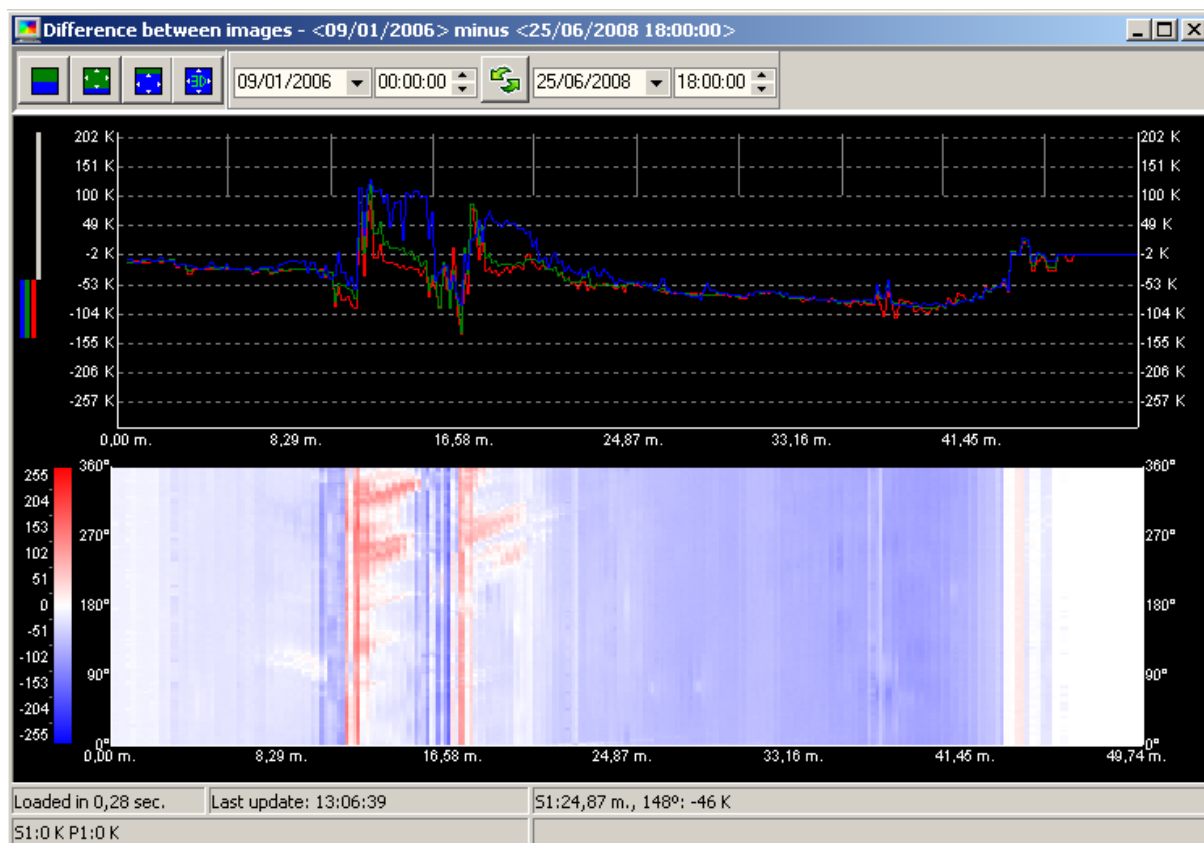

Figure 77: Difference between images screen



The range of temperatures to be shown can be defined in CS Config as described in section 6.2.2 <Colours and axes definition>!

Operation

7.2.14 User defined Start-up of Deneb

You can tell Deneb which windows to open when initializing. To do that, use the following parameters:

- \$LOGIN: User name
- \$PASSWORD: Password (this parameter is not compulsory if no password exists)
- \$PROFILE: Profile
- /REALTIME: Opens the window <Main> <Real time> automatically
- /SHORT: Opens the window <Main> <Historic time> <Short term> automatically
- /LONG: Opens the window <Main> <Historic time> <Long term> automatically
- /DIFFER: Opens the window <Graphi> <Difference between images> automatically

Example 1:

- User ADMIN with password 1234 and RAYTEK profile and real time screen

Then, the program call would be:

```
Deneb.exe $LOGIN ADMIN $PASSWORD 1234 $PROFILE RAYTEK /REALTIME
```

Example 2:

- User TEST without password and RAYTEK profile with short and long term history view

Then, the program call would be:

```
Deneb.exe $LOGIN TEST $PROFILE RAYTEK /SHORT /LONG
```

8. Options

8.1 Start-up-Service

The start-up service includes the installation of the scanners into the protective housing boxes, **checking** all wiring, communications and services from the scanners to the location of the computer. The scanner alignment will be checked and corrected as necessary. Software will be installed, and all users will be trained on the full operation of the system, including routine maintenance procedures. The entire system will be operational before the final acceptance and sign-off by the customer. Raytek **does not** provide construction, erection, mechanical, electrical or building services. Prior to the start-up service the scanner housings should be installed in the designated locations per our recommendations. All wiring should be in place and the associated electronics positioned in the control room. Raytek will check the final connections and power the system. The scanner heads should not be put into the protective housings until this start-up service begins.



The start up service option is not included in the CS210 standard package, it must be ordered as a separate line item!

9. Accessories

9.1 Overview

Accessories include items that may be ordered at any time and added on-site.

- [Serial RS485 / RJ45 Ethernet Converter](#) (XXSYSCS210CON)
- [Fan Control](#)
- [LRM – Live Ring Migration](#) (XXTCSLRM210)
- [Shadow Monitoring](#) (XXTCS200SM)
- [Burning Zone Monitoring](#) (XXTCS200BZ)
- [Internal Heater](#) for system connection box (XXSYSCONNBOXHEAT)
- [Laser Distance Meter](#) (XXSYSLDM) for distances up to 60 m (197 ft), recommended for an exact gathering of the linescanner-to-kiln geometry

9.2 Serial RS485 / RJ45 Ethernet Converter

The serial RS485 / RJ45 Ethernet Converter (XXSYSCS210CON) is a dedicated device server for connecting up to four RS485 devices to a TCP/IP network.

The serial RS485 / RJ45 Ethernet Converter must be installed in case of having either one or all accessories such as Fan Control, Burning Zone Monitoring, Shadow Monitoring, or Live Ring Migration. The converter must be mounted in the system connection box in the field. For both CS211 and CS212 only one converter is required.



Figure 78: Serial RS485/ RJ45 Ethernet Converter

9.2.1 Technical Data

Ethernet Communications

Speed	100 Mbit/s
Ports	2x
Port connector	RJ45
Protection	built-in 1.5 kV magnetic isolation
IP-address	192.168.42.10 (default)

RS485 Communications

Ports	4x
Port connector	DB9 male
Protection	built-in 15 kV ESD for all signals

Software

Driver support	Windows 2000/XP/Vista/Win 7
Utility software	Serial Device Server Configuration Utility (on the Support DVD) for installing Virtual COM ports

Mechanics

Dimensions (W x H x D)	55 x 140 x 95 mm (2.1 x 5.5 x 3.7 in)
Mounting	DIN-rail

Power

Power input	12 to 48 VDC, redundant dual inputs
Power connector	terminal block
Power consumption	4 W

Accessories

Environment

Operating temperature	0 to 60°C (32 to 140°F)
Storage temperature	-20 to 80°C (-4 to 176°F)
Operating humidity	5 to 95% RH

9.2.2 LED Indicators

There are LEDs display the power status, network status, and serial communication status located on the front panel of the Serial RS485 / RJ45 Ethernet Converter, each of them has its own specific meaning as below table.

LED	Color	Description
P1	Green	Power 1 is on.
	Off	Power 1 is off, or power error condition exists.
P2	Green	Power 2 is on.
	Off	Power 2 is off, or power error condition exists.
Status	Orange	Blinking: System is ready. Steady on: the device has been located by utility's location function.
	Off	System is not working.
Ethernet	Orange	Blinking: Ethernet port is transmitting or receiving data. Steady on: Ethernet has the good link for 10 Mbps or 100 Mbps operations.
	Green	On: 100 Mbps Ethernet connection Off: 10 Mbps Ethernet connection
	Off	
Serial	Orange	Serial port is transmitting data.
	Green	Serial port is receiving data.
	Off	No data is transmitted or received through the serial port.

Table 1: LED Indicators

9.2.3 Driver Installation

The following procedure describes the way to install a virtual COM port on the CS computer by using the Configuration Utility Software. The virtual COM ports work like standard Windows COM ports, so the CS software sees no difference between both.



Please reserve TCP/UDP port 5048 and 5058 in your Ethernet network, Configuration Utility Software will use these ports to communicate with the Serial RS485 / RJ45 Ethernet Converter! Make sure that a possible firewall does not block these ports!

1. Power on the Serial RS485 / RJ45 Ethernet Converter!
2. Insert the Advantech driver utility DVD for the Serial RS485 / RJ45 Ethernet Converter into the DVD drive (e.g. E:\) on the host PC.
3. Use Windows explorer to execute the setup program, the path for the setup program on the DVD should be:
E:\Utility& Driver\SerialDeviceServerConfigurationUtility\Serial_Device_Server_Configuration_Utility_[*Version*]-Release_[*date*].exe

- After the installation is finished, open the Serial Device Server Configuration Utility from the Windows Start Menu by clicking <Start> <All Programs> <Advantech eAutomation> <Serial Device Server Configuration Utility>. The Serial Device Server <XXSYSYCS210CON> will appear in the sub-tree of Device Server List area as shown below (may take several seconds).

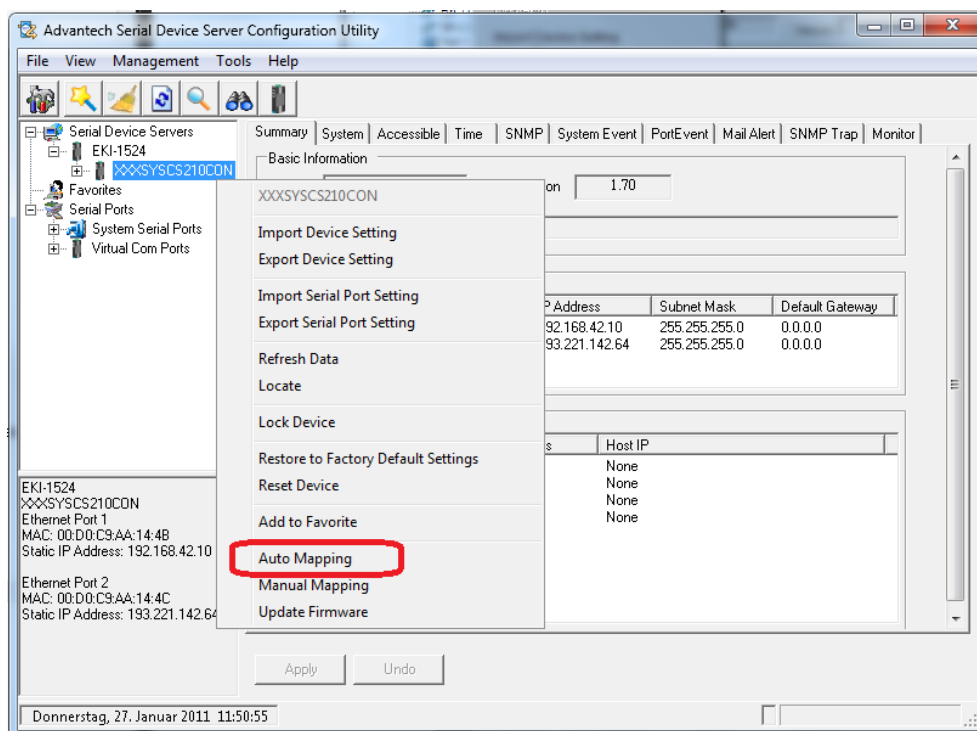

Figure 79: Selecting the <Auto Mapping> Function

- Right click the serial device <XXSYSYCS210CON> and select the “Auto Mapping” function.
- The serial ports that can be assigned to virtual COM will be shown in the following window. Click the <Select All> button and press <Map Selected Ports> button. All selected serial ports will be mapped to virtual COM ports in sequential order.

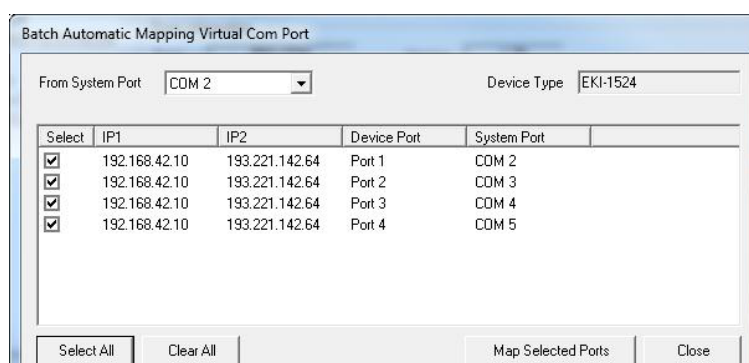

Figure 80: Mapping of Virtual Ports

- The COM ports in the <Virtual Com Ports> listing are now available for use by Windows applications.

Accessories

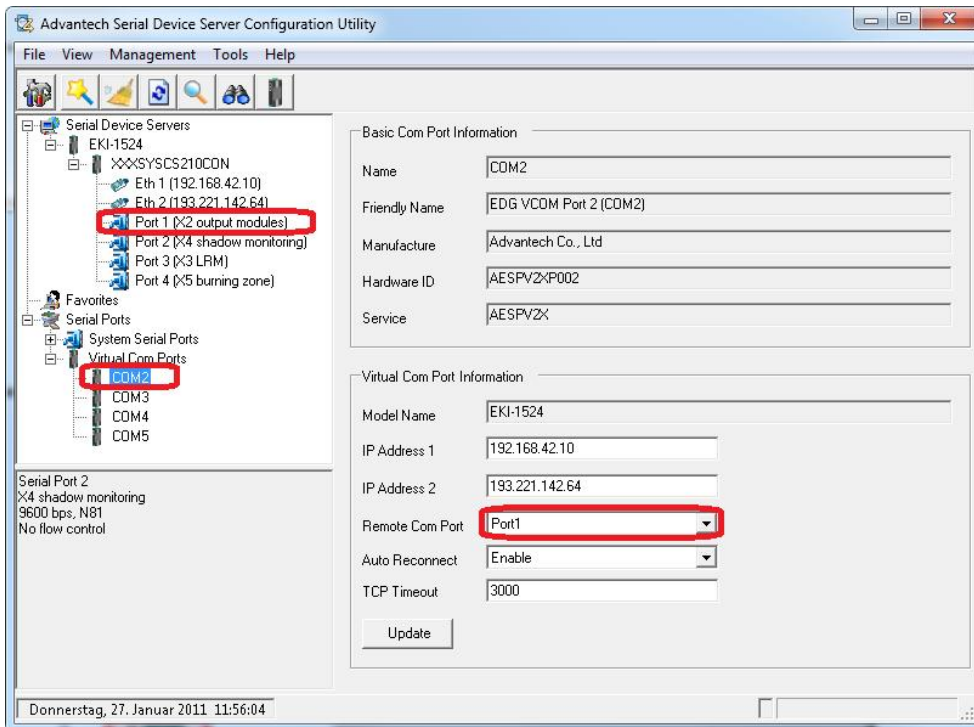

Figure 81: COM Ports in the “Virtual Com Ports” Listing now available for the CS Software

8. The configuration for the four ports of the serial device <XXXSYSCS210CON> are preset in accordance to the available CS accessories, e.g. port 1 is configured as RS-485 type for communicating with the output modules to be wired at connector X2 in the system connection box. In the example above port 1 is assigned to the virtual COM port 10 to be used in the CS software configuration.



It is not recommended to change the preset configuration for the four ports of the serial device <XXXSYSCS210CON>!

9.3 Fan Control

In order to ensure lining durability and avoid kiln deformation during normal operation, kilns may require additional cooling from fans. The Fan Control system will enable the operating personnel to automatically turn on or off fans in up to 48 user set control zones.

You may add additional Fan Control output modules to increase the number of available outputs.

Types of output modules:

- XXXSYS16DA: digital output module 7043, 16 channels, open collector
- XXXSYS7RA: digital output module 7067, 7 channels, potential free relay contacts

9.3.1 Technical Data

Common Features

power input:	+10 to +30 V
power consumption:	typ. 2 W
dual watchdog:	power-on start value and safe value for host failure
operating temperature:	-10 to + 70°C (14 to 158°F)
storage temperature:	-25 to + 80°C (-13 to 176°F)
humidity:	5 to 95%, non-condensing

XXXSYS16DA

type:	7043
channels:	16 open collector outputs, non isolated
max load current:	100 mA
max load voltage:	30 V

XXXSYS7RA

type:	7067
channels:	7 relay outputs, potential free contacts
contact rating:	0.5 A @ 120 VAC, 1 A @ 24 VDC
operate time:	5 ms

9.3.2 Installation

For more technical information see appendix 13.6 [Output Modules](#), page 119.

For the detailed wiring see appendix 12.6 [Fan Control Wiring](#), page 108. Alternatively to the field installation of the digital output modules in the system connection box, the hardware can also be installed in the control room. Please contact the technical support for further details.

9.4 LRM – Live Ring Migration

In order to avoid kiln deformation that can damage refractory kiln torsion must be kept within certain limits. Kiln shell torsion is greatly affected by the degree of clearance between the tires and the kiln shell. The simplest and most accurate procedure is to measure the kiln shell's rotational speed as compared to the rotational speed of the tires. The result is termed as tire slip. The Live Ring Migration System is an automatic measurement and registration system designed to monitor tire slip and alert the user when the system exceeds user-defined limits.

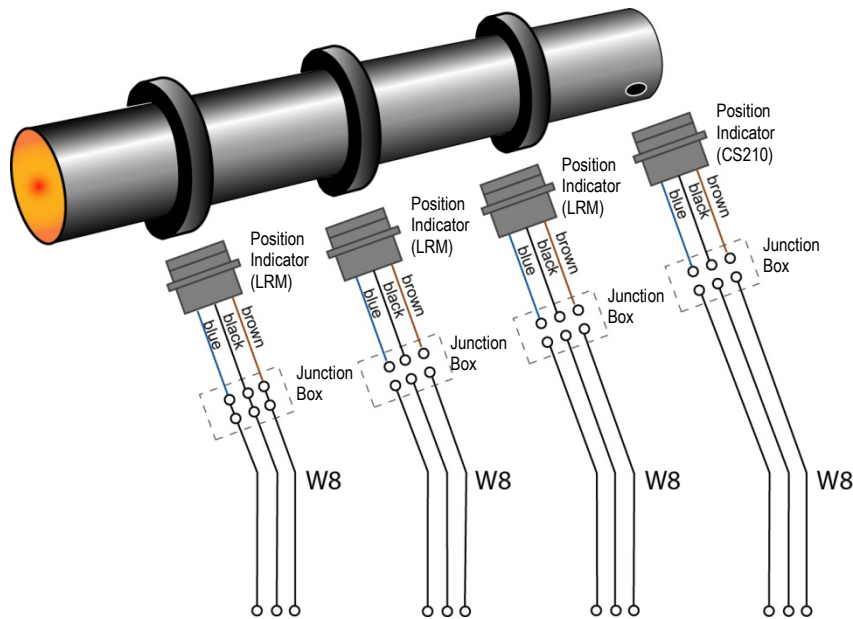

Figure 82: Monitoring of Rings

For an overview of a CS210 system with LRM, see section 12.2 [CS212 Installation with Accessories](#), page 103.

Delivery:

- Position indicator with junction box, 3 position indicators delivered for monitoring of 3 tires (each further tire requires an additional position indicator XXXSYSECPI, up to 6 tires can be monitored with the LRM system)
- LRM Remote Control

9.4.1 Functionality

The LRM system monitors tire slip by measuring the rotational speed of the kiln shell and of each tire. The rotation time differences between the shell and each tire are converted to a radial slip.

The electronics in the LRM remote control box captures the trigger signals from the different rings and send <ring number> and <time stamp> to the PC via serial communication.

9.4.2 LRM Remote Control

The LRM remote control box contains a micro PLC and an RS485 communication port, all in a protective housing. The measured values for the kiln and for each of the tires are then sent to the computer through the RS485 port.

For more technical data, see section 12.7 [LRM Wiring](#), page 109.

9.4.3 Position Indicator

Temperature resistant inductive proximity switches are used to trigger the PLC counter rotation time. The trigger bar for the position indicator is welded directly onto the tire.

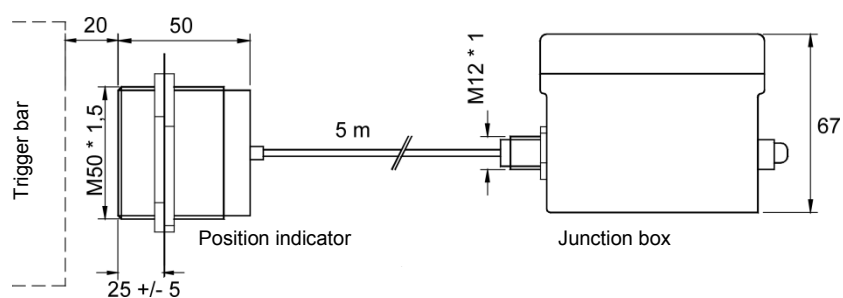

Figure 83: Position Indicator and Trigger Bar

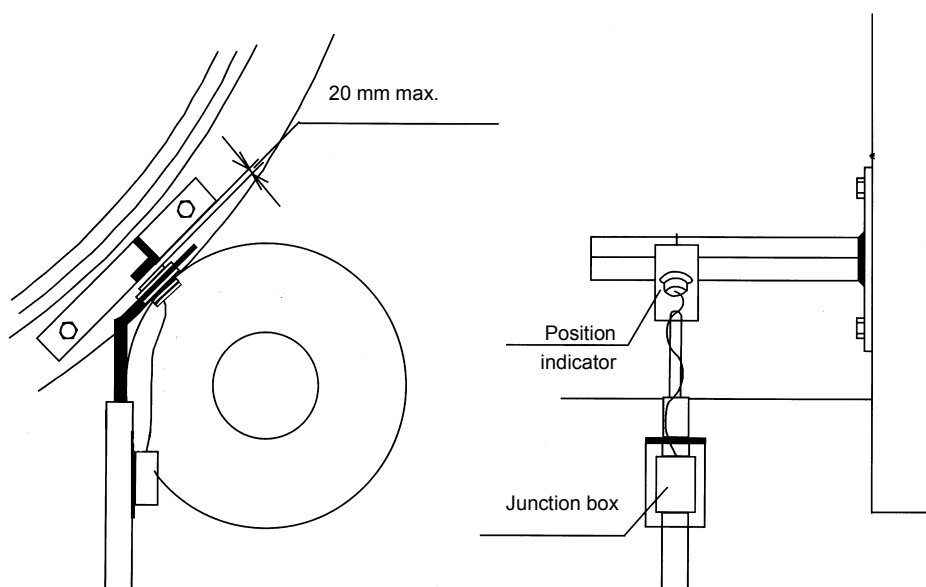

Figure 84: Mounting the Position Indicator

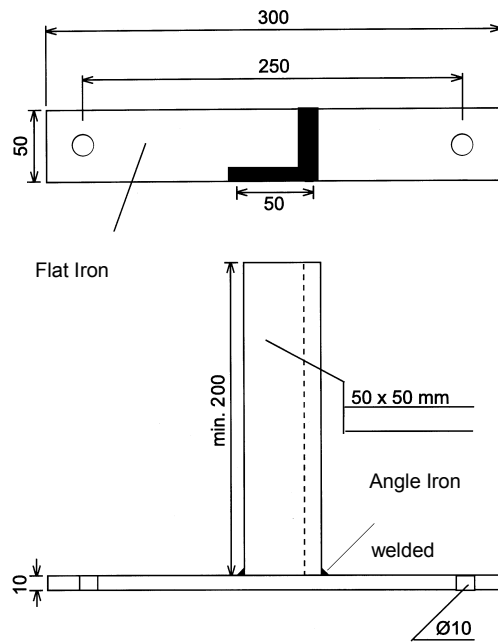

Figure 85: Trigger Bar – details –

9.4.4 Wiring

For the detailed wiring of the LRM see section 12.7 [LRM Wiring](#), page 109.

For recommended cables see section 4.5 [Cable Requirements](#), page 14.



The CS210 position indicator (master) must be wired to the <kiln trigger> labeled input on the terminal line of the LRM remote control box! All subsequent LRM position indicators must be wired to the inputs <Ring 1>, <Ring 2> and so.

9.5 Shadow Monitoring

The linescanner can be hindered from monitoring the complete kiln by physical obstructions and also by shadows from the tires. With the Shadow Monitoring Package (XXXTCS200SM) up to 32 additional pyrometers can be installed and configured to monitor these “shadowed” portions. The temperature values from these pyrometers are integrated in the scanned data from the linescanner and the results are displayed as one homogenous thermogram.

For an overview of a system configured with Shadow Monitoring, see section 12.2 [CS212 Installation with Accessories](#), page 103.

Delivery:

- MIH sensor
- Air purge jacket for MIH sensor, stainless steel
- Adjustable mounting bracket
- MI connection box

Mounting:

The recommended MI sensor mounting is shown in the figure below. The angular alignment of the sensor head reduces the risk of possible contaminations on the optics.

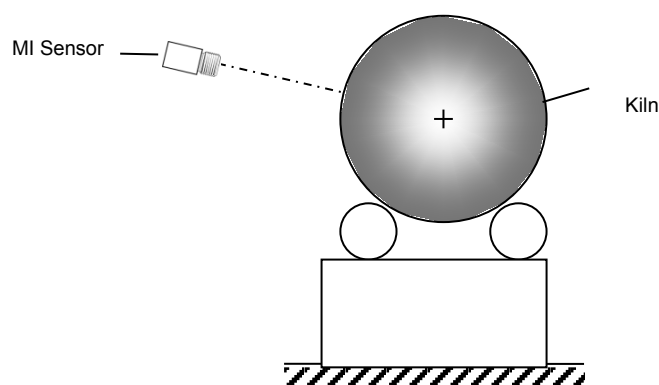

Figure 86: Recommended Alignment of MI Sensor



Make sure that the resulting spot size for the MI sensor covers the size of the shadowed area!

Example:

Optical resolution for the MI sensor:	10:1
Distance to the kiln	5000 mm (200 in.)
Resulting spot size:	500 mm (20 in.)

Wiring:

For an installation of two or more shadow sensors in a network, each sensor is wired parallel to the others. You may connect up to 32 units. Make sure to deactivate the preset shunt resistor for all units

Accessories

except for the last one in the chain. The switch for activating the shunt is found on the sensor circuit board as shown in the figure below. To switch the shunt you must first open the box lid.

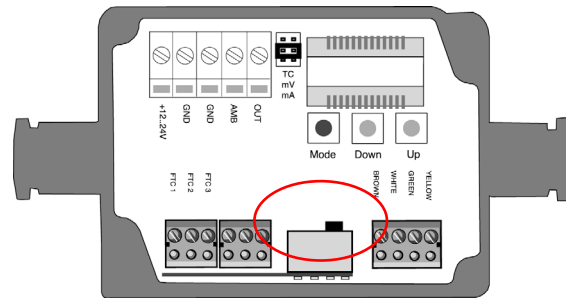

Figure 87: MI Electronic Board with Activated Shunt

For detailed wiring of Shadow Monitoring see section 12.8 [Shadow Monitoring Wiring](#), page 112.

For recommended cables see section 4.5 [Cable Requirements](#), page 14.

Technical data:

Temperature range	-40 to 600°C (-40 to 1112°F)
Spectral response	8 to 14 μm
Accuracy	± 1% or ± 1°C (± 2°F) whichever is greater
Optical resolution	10 : 1 (90% energy)
Head ambient temperature	0 to 180°C (32 to 356°F)
Head cable length	8 m (26 ft.)
Protection rate (head)	IP65 (NEMA-4)
Digital interface	RS485

For other technical data see MI operators manual.

9.6 Burning Zone Monitoring

With Burning Zone Monitoring (XXXTCS200BZ) a two-color point sensor (MR ratio pyrometer) can be installed looking into the burn zone of the kiln to monitor the temperatures in this very important area. The two-color unit will essentially “see” through the smoke and other by-products of combustion and the temperature reading will be displayed on the main screen.

For an overview of a system configured with Burning Zone Monitoring, see section 12.2 [CS212 Installation with Accessories](#), page 103.

Delivery:

- ① MR ratio pyrometer, type: MR1SB
- ② MR connection box
- ③ High temperature cable, 15 m
- ④ ThermoJacket for MR pyrometer, with adjustable mounting bracket
- ⑤ Blast gate assembly with quartz window
- ⑥ Sighting tube, 30 cm length, stainless steel
- ⑦ Adjustable pipe adapter assembly
- ⑧ Air flow regulator
- ⑨ Air pressure regulator

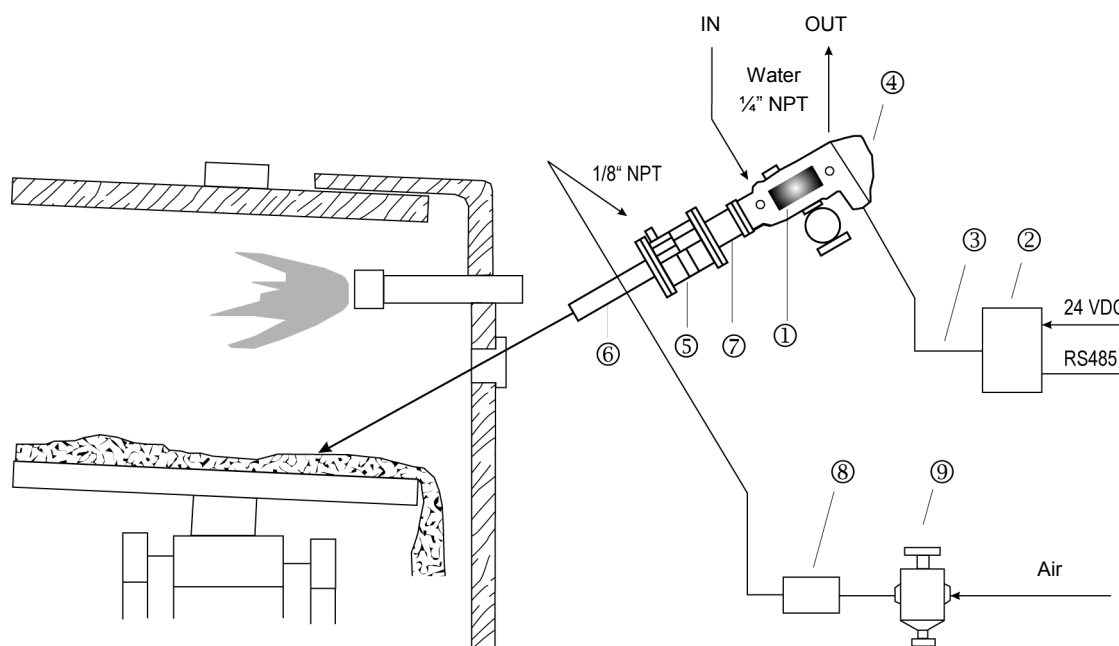

Figure 88: Installing the Burning Zone Pyrometer

Accessories

Wiring:

For detailed wiring of Burning Zone Monitoring see section 12.9 [Burning Zone Wiring](#), page 113.

For recommended cables see section 4.5 [Cable Requirements](#), page 14.

Technical data:

MR temperature range	700 to 1800°C (1292 to 3372°F)
Spectral response	1 µm nominal
Accuracy	± (0.5% T _{measured} + 2°C), T _{measured} in °C
Optical resolution	82 : 1 (95% energy)
Protection rate (sensor)	IP65 (NEMA-4)
Ambient temperature	
without cooling	0 to 50°C (32 to 122°F)
with ThermoJacket	up to 315°C (600°F)
Cable length	15 m (49 ft.)
Digital interface	RS485

For other technical data see MR operators manual and the ThermoJacket operators manual.

9.7 Internal Heater

The internal heater is for the use in the system connection box for ambient temperatures below 0°C (32°F).

The surface temperatures on the accessible side surfaces of the housing are kept down as a result of the heater design. The heater comes with plug-in thermostat and is designed for permanent operation.

Technical data:

Voltage	100 to 240 VAC
Heating capacity	max. 50 W (170 BTU/hour)
Wiring	cable diameter max. 2.5 mm ² (AWG 14)
Mounting	DIN rail
Fitting position	vertical
Operating temperature	-20 to 70°C (-4 to 158°F)
Storage temperature	-45 to 70°C (-49 to 158°F)

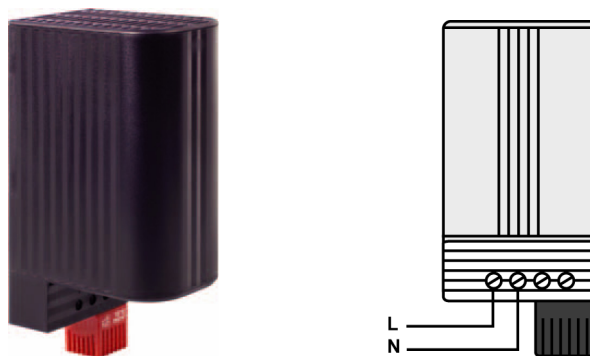

Figure 89: Internal Heater (left: photo, right: connection)

For more detailed information see section 12.3 [System Connection Box Wiring](#), page 104.

Auxiliary Software

10. Auxiliary Software

The CS software package contains several auxiliary software applications designed to ease installation and maintenance. The programmes explained in this section don't have shortcut icons on the desktop or in the initialization menu. Therefore they reside in the program folder.

10.1 Managing the CS Database with DBCheck

Using DBCheck to manage the CS database, the user will be able to migrate from existing CS100 databases, import and export configurations, and create backup copies.

The SQL server will be installed automatically during the CS installation procedure. The SQL server currently comes as Microsoft SQL Server 2008 R2 Express. The maximum size for the database is given about 10 GB.

10.1.1 Starting the DBCheck application

The <DBCheck.exe> file can be found in the CS installation program folder. Double click to execute the file.

10.1.2 Connecting to the database

On the <DBCheck> main screen the user has to select an available profile to connect to the database.

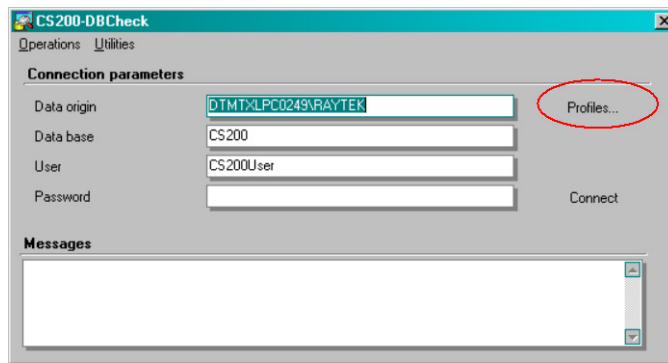
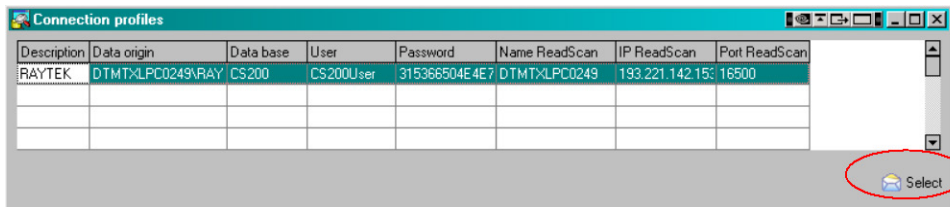
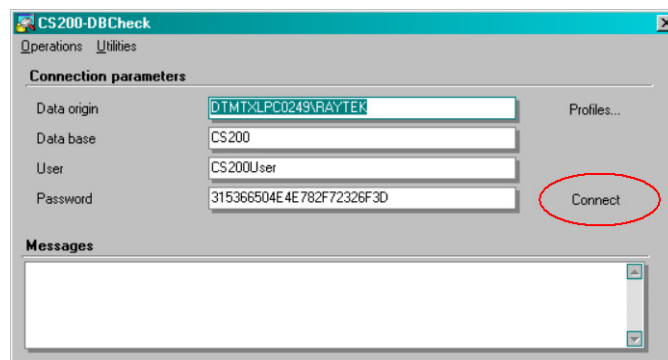

Figure 90: <DBCheck> main screen

Click on <Profiles...>



Click on <Select>



Click on <Connect>

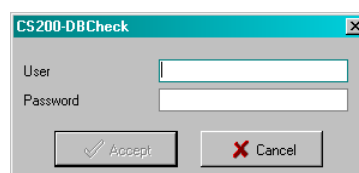

Once you insert a valid user name and password, you will get the following screen. Under the <Messages> view make sure that connection has been established to the database.

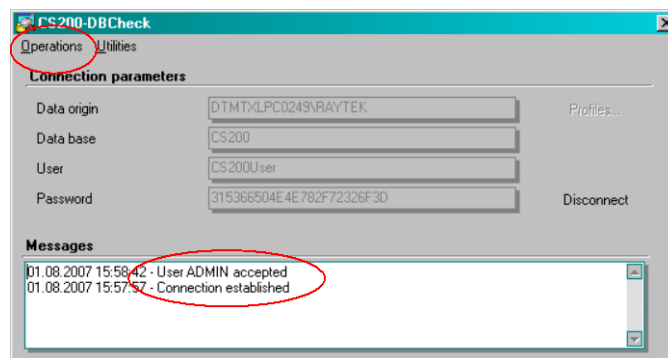

10.1.3 Migrating pre-existing CS100 data

You can migrate pre-existing CS100 data to the newer system.

Go to <Operations> and select <Migrate old version>. The following screen appears. Under <Old CS100 Deneb.ini> you have to browse until you find the CS100 configuration file to be migrated. Under <Origin MDB-File> you have to select the old CS100 database. Additionally, you can select which information to migrate: <Configuration> (refractory zones and alarms, scanner's position, ...) and/or <Temperatures> (saved images subsequent to the date shown).

Click on <Migrate> button to start the migration process. Depending on the amount of data to be migrated, the migration process could take twenty or thirty minutes or more.

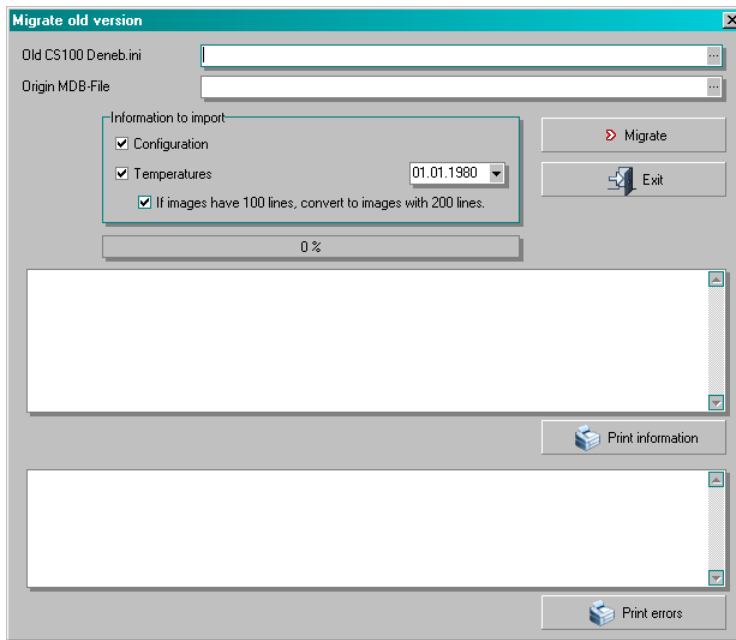

CS210 has many features that did not exist in CS100 and therefore parameters for these functions will not be migrated. Further, the system physical configuration may have changed since the original installation. Therefore we strongly recommend that you verify all parameters using the CS Config utility!



It is strongly recommended to migrate old CS100 data from local drives only!

10.1.4 Import and export CS configurations

The CS database contains all thermal images saved over the lifetime of the system. As a consequence, it will be a very large file in a range of several hundred MByte. In the case of service assistance, such big files are very difficult to send e.g. via email. The <Import and export> function can be used to create a consolidated, small text file containing the CS configuration parameters only but no thermal images.

Go to <Operations> and select <Import and export>. Fill the <File> edit box to address the file being imported (Import) or fill the <Folder> edit box to give a path for the file being exported.

Click on either the <Import> or <Export> button respectively to complete the desired operation.

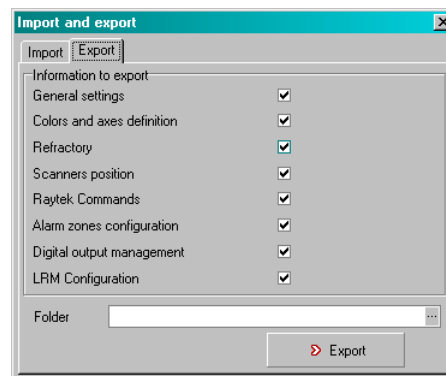

It is always highly recommended to revise every imported parameter using CS Config!

10.1.5 Creating a backup file

Go to <Operations> and select <Backup copies>.

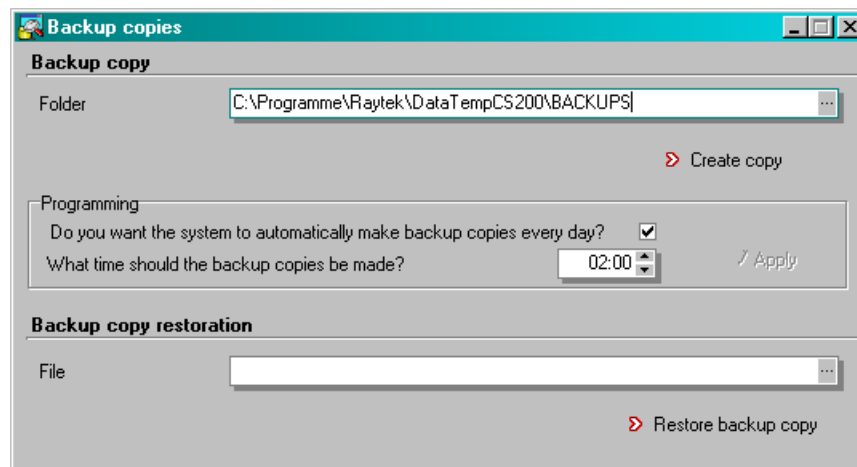

In the <Folder> edit box, enter the path where you wish to save the backup copy of the database. Click on the <Create copy> button to start the operation immediately which could take several minutes. Finally you will get a *.bak file in your folder as a copy of the current CS database.

If you wish to restore a database backup copy, type the name of the file where the copy is stored in the <File> edit box, and then click on the <Restore backup copy> button.

Automatic backup copy

To program a backup copy execution, follow the steps below:

- Activate the checkbox for making a backup copy every day
- Set the time for the execution of the automatic backup copy in <What time should the backup copies be made>.

From this moment, a daily backup copy will be automatically created on the set time.

The folder entered for the backup copy must not be edited, removed or deleted since ReadScan must recognize it in order to periodically access it.

Auxiliary Software



It is advisable to choose a time for automatic backup where nobody is working with the application, for instance during the night or early morning!

10.1.6 Reset database

Go to <Operations> and select <Reset database>. Clicking on the <Empty BD now> button starts the CS software with an empty database by deleting all data in the SQL database. To avoid accidental data loss, a backup copy will be stored automatically in the CS subfolder BACKUP.

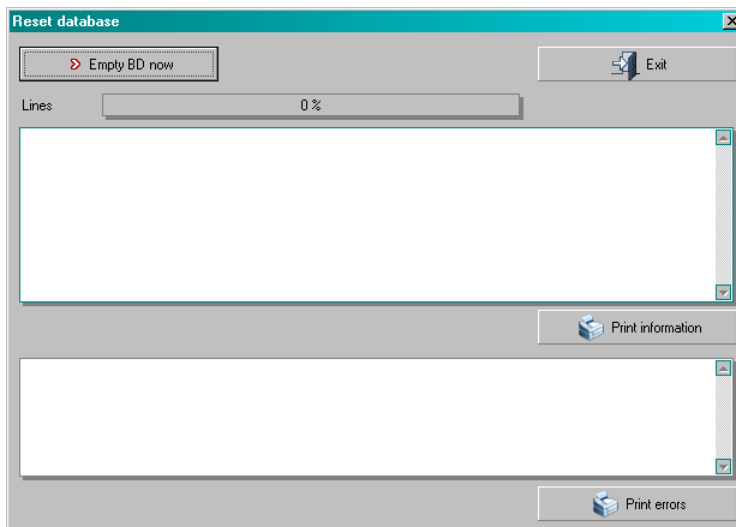

10.2 Remote Access from a Client PC

In order to access the CS software from a client PC (another networked PC) you must do the following:

Start the <DBCheck.exe> file on the remote PC

Open the <Connection Profile>

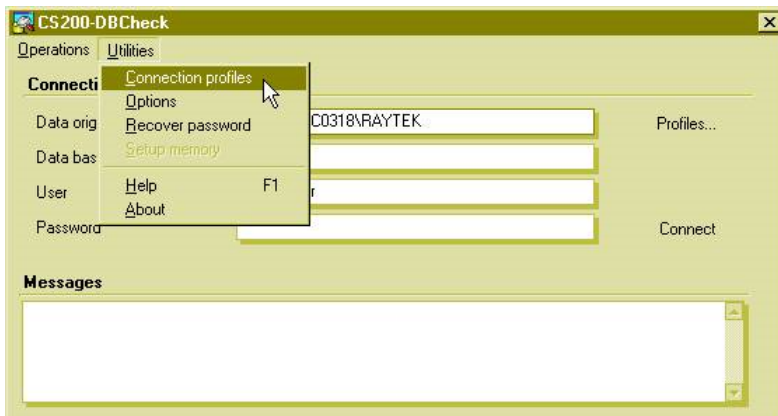

Under <Data origin> add port 1433 (TCP/IP port of the SQL database) to the selected profile (comma as separator)

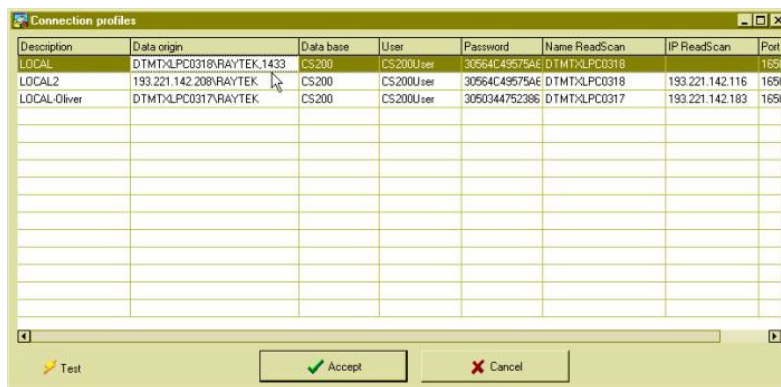

Description	Data origin	Data base	User	Password	Name ReadScan	IP ReadScan	Port
LOCAL	DTMTXLP0318\RAYTEK.1433	CS200	CS200User	30564C49575AE	DTMTXLP0318		165
LOCAL2	193.221.142.208\RAYTEK	CS200	CS200User	30564C49575AE	DTMTXLP0318	193.221.142.116	165
LOCAL-Oliver	DTMTXLP0317\RAYTEK	CS200	CS200User	3050344752386	DTMTXLP0317	193.221.142.183	165

enter the shared folder <DataTemp CS> on the server PC (PC running CS software) from that client PC. Once there, run the <Icons> program, which will create the shortcuts for network access automatically.

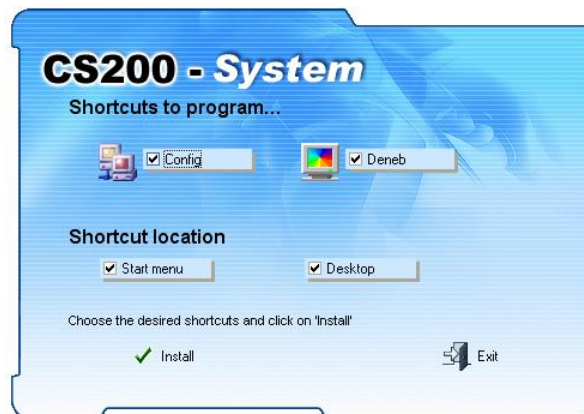

Figure 91: Window of the Icons program

10.3 Device Testing Programme: PComm

In order to verify the device connections to the PC, use the <PComm> auxiliary program. To run it, you must click on the program executable which can be found in the CS installation folder.



Make sure that the <Readscan> application is stopped before launching the <PComm> program!

10.3.1 <Check operation> Window

Under <Main> you can find the <Check operation> menu showing the communication parameters for all possible serial devices.

To verify the device connection to the PC, select the device to be connected, the port and the baud rate for the connection.

Auxiliary Software

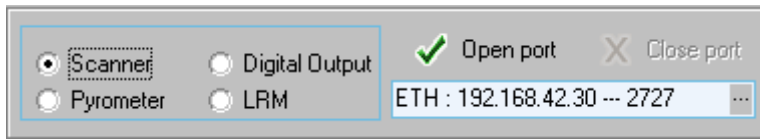

Figure 92: Options detail

Once the options have been selected, click on the <Open port> button.

10.3.1.1 Scanner

If the selected device is a scanner and its options have been correctly configured, the system will start the connection to the device. If the connection wouldn't go through, an error message will be displayed.

The vertical bar on the right-hand side of the thermogram (see red arrow) shows the on/off status of the kiln trigger.

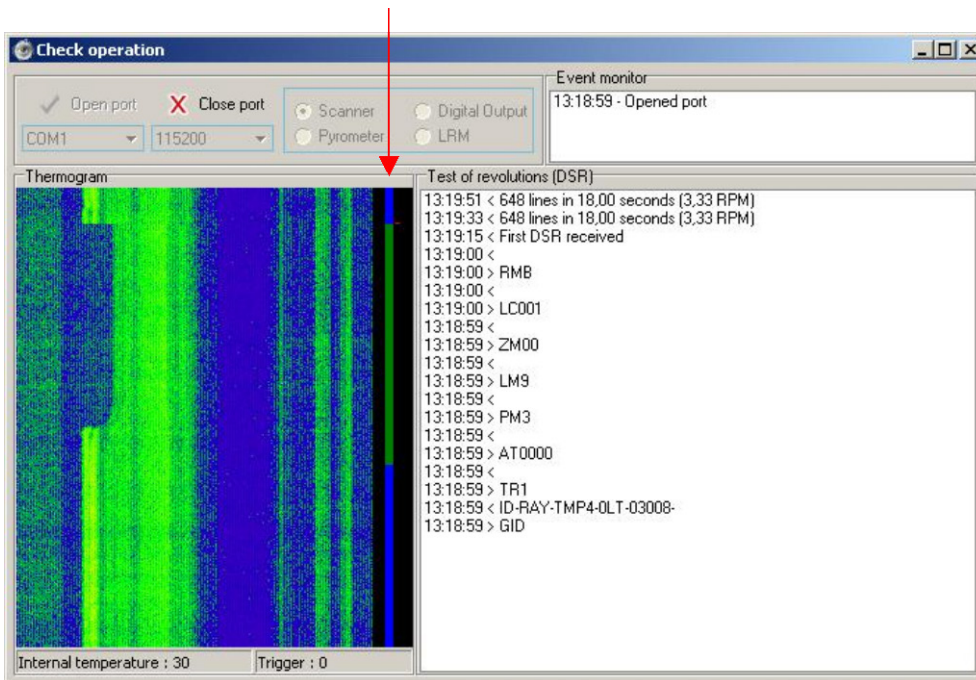

Figure 93: Scanner screen

10.3.1.2 Pyrometer

If the selected device is a pyrometer and its options have been correctly configured, the system will open the port. Next step will be to select the address of the pyrometers to which you want to establish connection. Then, click on the green arrow. If the connection goes through, the connected pyrometers as well as their features will show in the screen.

If, on the other hand, any of the options has not been properly entered, or if the connection with any of the devices did not go through, an error message will be displayed.

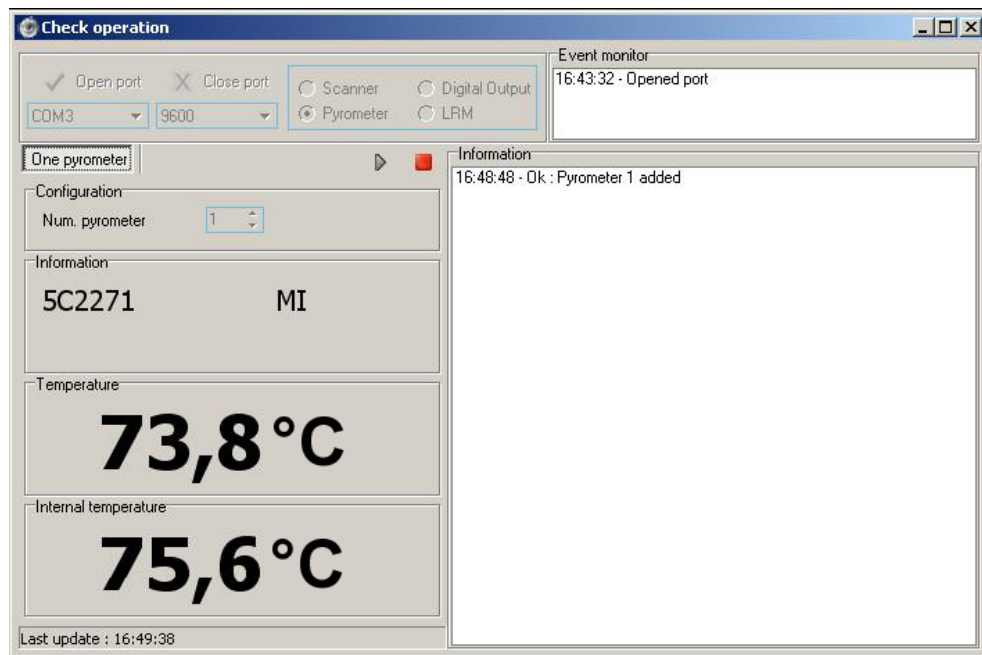

Figure 94: Pyrometer screen

10.3.1.3 Digital Output

If the selected device is <Digital Output> and its options have been correctly configured, the system will open the port. Next step will be selecting the interval of the output module addresses connected to the PC, and then, click on the green arrow. If the connection goes thru, the connected digital output modules as well as their features will show in the screen.

If, on the other hand, any of the options has not been properly entered, or if the connection with any of the devices did not go thru, an error message will be displayed.

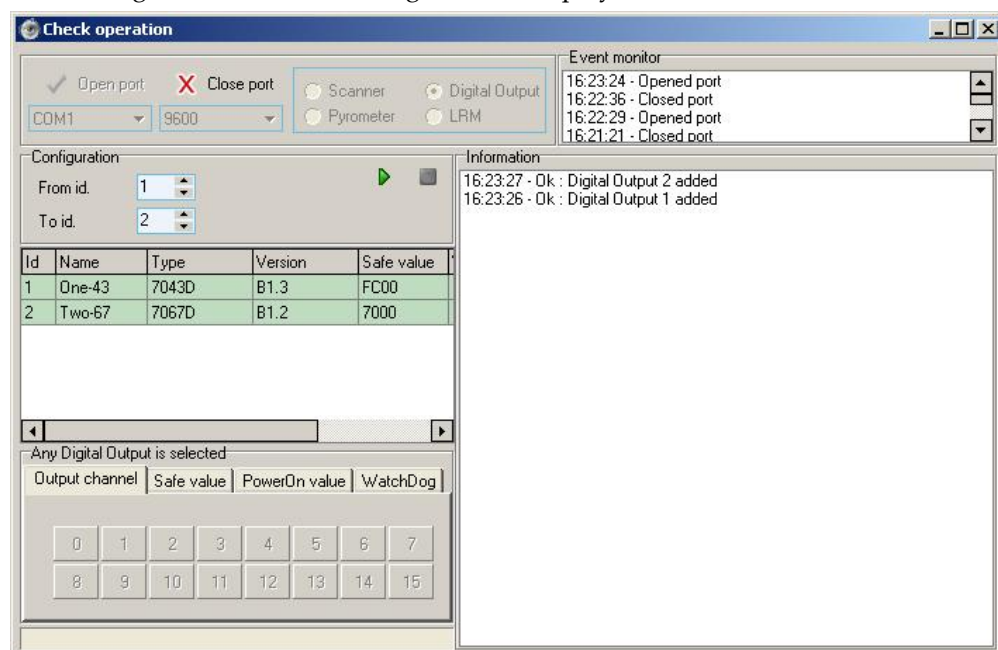

Figure 95: Digital Output screen

Auxiliary Software

The tabs at the bottom of the screen show the features of the different digital output modules, and allow the user to conduct a performance check to confirm that they are working properly.

10.3.1.4 LRM

If the selected device is a <LRM> and its options have been correctly configured, the system will start the connection with that device. Once connected, the information from each ring will begin to display on the screen as soon as a kiln trigger actuates the proximity sensor.

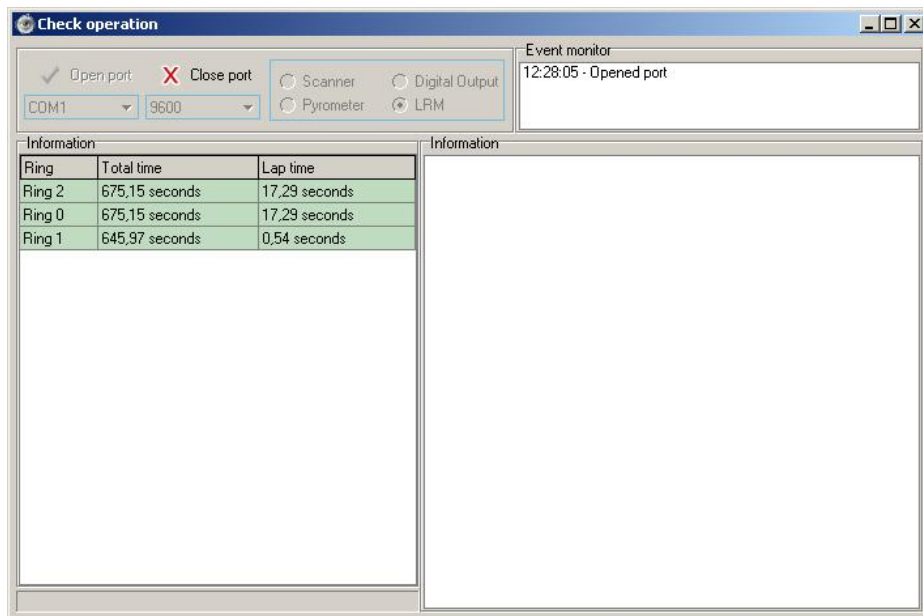

Figure 96: LRM Screen

11. Troubleshooting

You can find a troubleshooting guide for common system problems in the MP150 Linescanner manual.

CS210 specific problems you can find listed below.

Checkpoint	Possible Cause / Solution
Kiln Trigger	<ul style="list-style-type: none">• The system has lost synchronization due to missing signals from the position indicator:<ul style="list-style-type: none">○ Check alignment and distance between trigger bar and position indicator.○ Increase the metal mass of the trigger bar for a reliable signal generation.○ Check the wiring.• Note: The trigger signal can be verified by a blinking LED on the junction box located close to the position indicator!
Scanner	<ul style="list-style-type: none">• The power for the scanner should have 18 VDC minimum at the system connection box close to the scanner's location.• Note: The scanner can be checked directly in the field with a laptop via the communication interface in the system connection box with the software tool "PComm.exe" found in the CS installation folder!
Ethernet Communication via Fibre Optic	<ul style="list-style-type: none">• If there is no communication after installation and powering of all components required - please check the 'cross-over' of the two fibres between the glass fibre converter in the field and the control room (TX is in all cases to be connected to RX of the other converter)!
Serial Communication via COM port	<ul style="list-style-type: none">• If there is no communication after installation and powering of all components required - use another PC or laptop (exclude DSR problem with the COM port)!
Database	<ul style="list-style-type: none">• Restart the CS software with an empty database temporarily!
LRM	<ul style="list-style-type: none">• Use only Raytek supplied position indicators!



To get quick help send a detailed error report to Raytek including the current CS configuration and/or the complete CS database! See more in section 10.1.4 [Import and export CS configurations](#), page 94.

Drawings

12. Drawings

12.1 CS212 Installation without Accessories

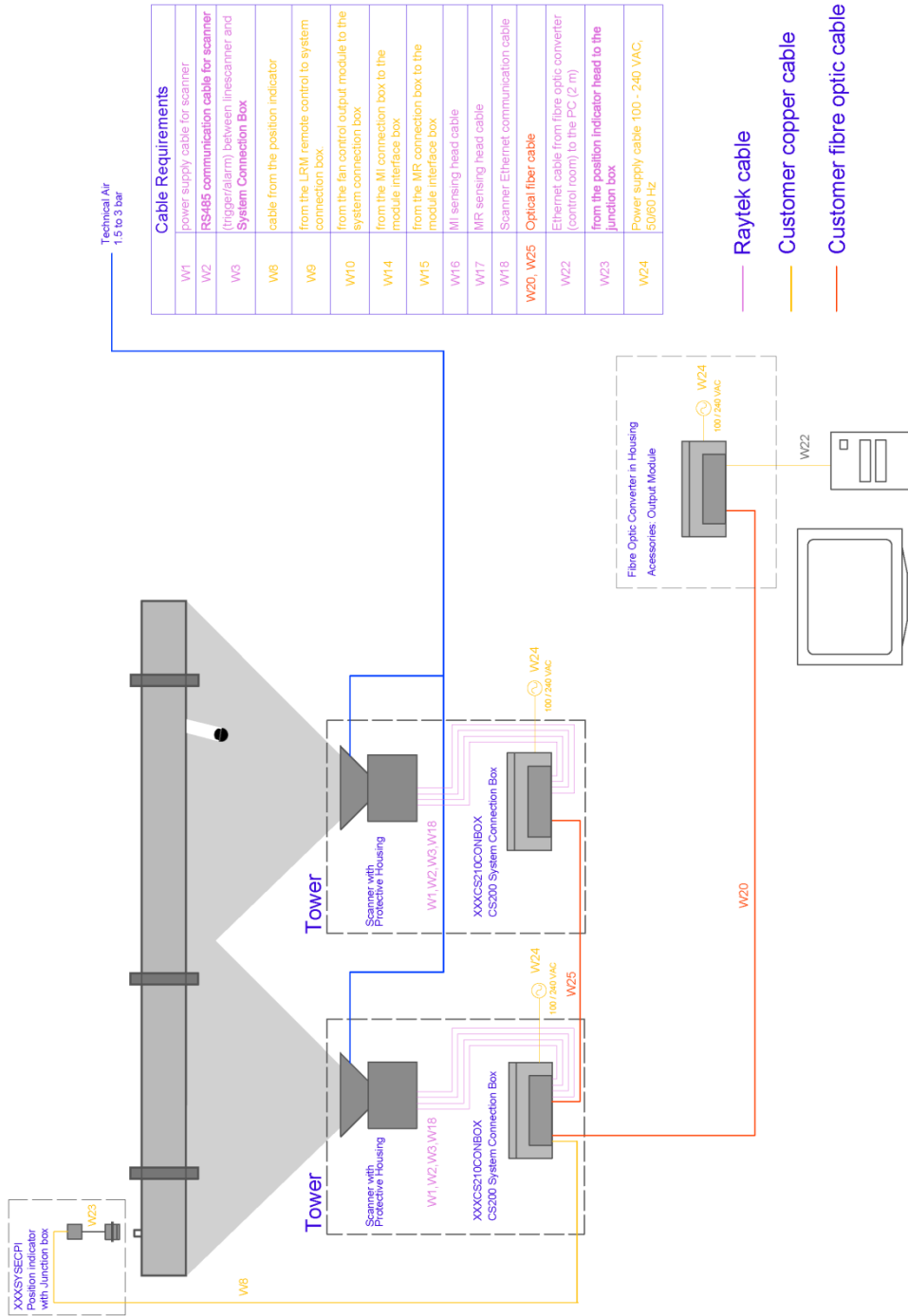

For more detailed information see section 4.5 [Cable Requirements](#), page 14.

12.2 CS212 Installation with Accessories

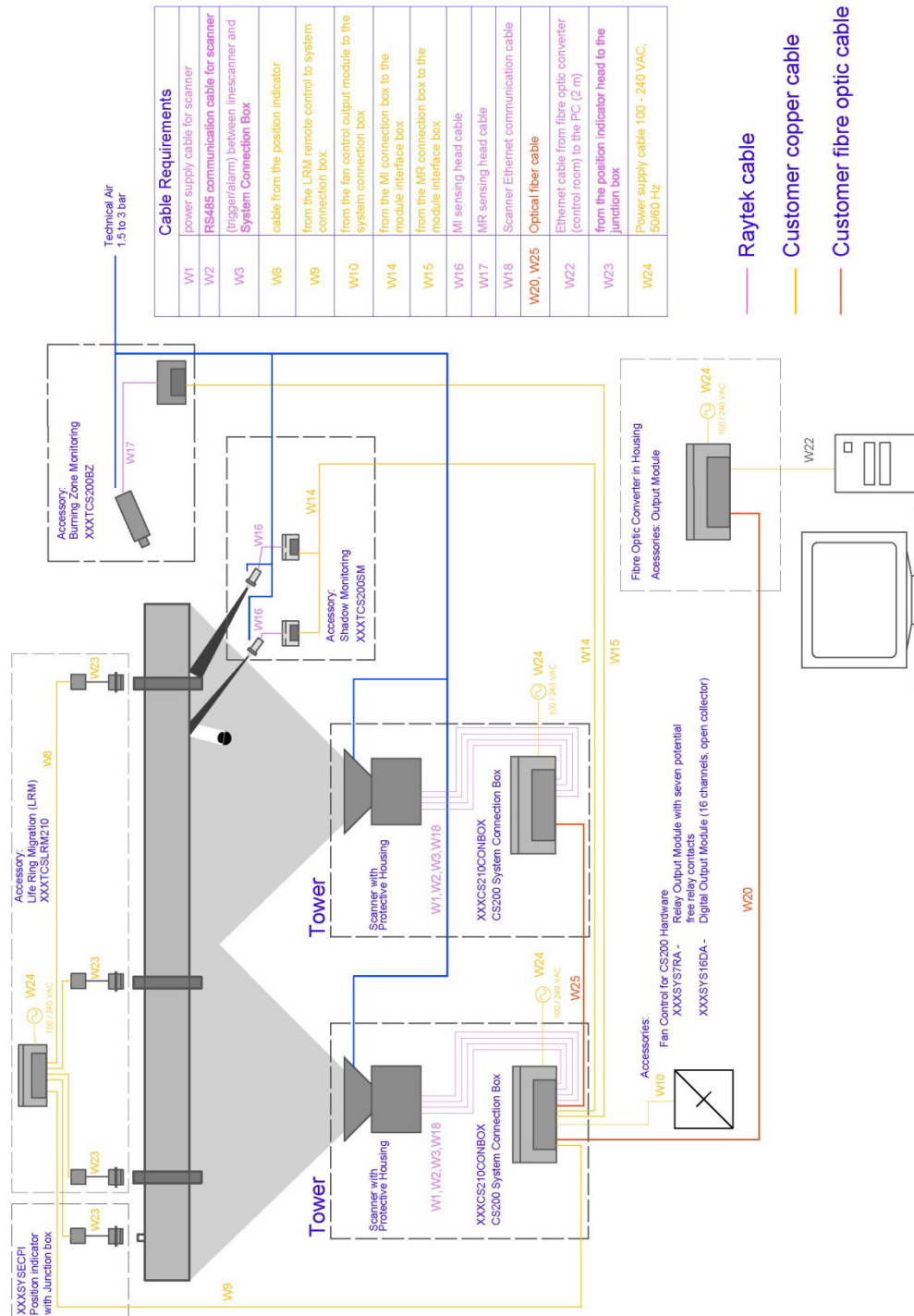

For more detailed information see section 4.5 [Cable Requirements](#), page 14.

Drawings

12.3 System Connection Box Wiring

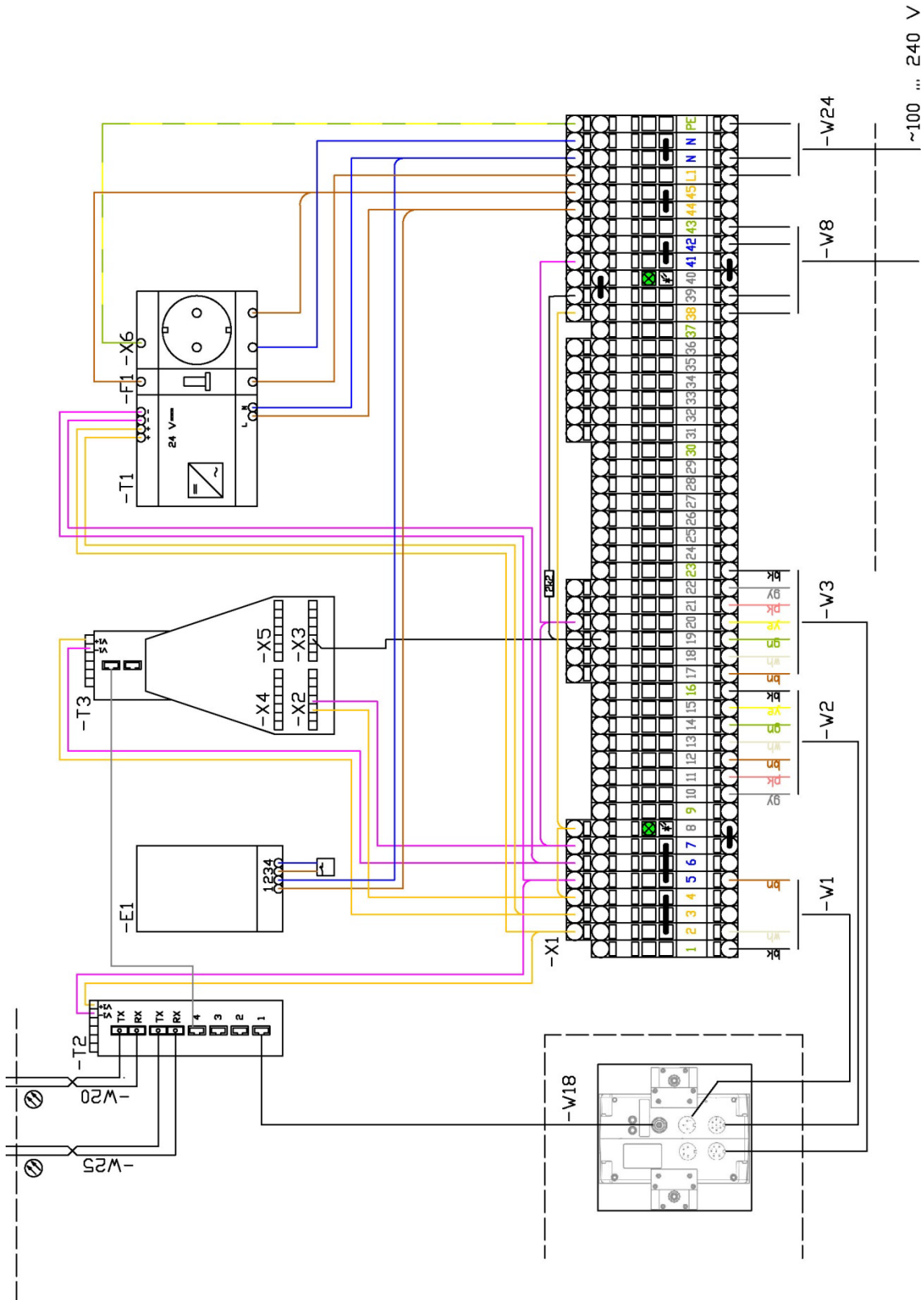

W1 – Power Supply 24 V, 3-pin

Description		Color (6 wires)	
1	GND	power ground	brown
2			not connected
3	+ 24 VDC	input for + 24 VDC power supply voltage	white
		shield	black

W2 – RS485 Interface, 7-pin

Description		Color (6 wires)	
1	GND	Ground, (connected to power ground)	gray
2	T+	RS485 transmit	brown
3	T-	RS485 transmit	white
4	R+	RS485 receive	green
5	R-	RS485 receive	yellow
6	n.c.		
7	+ 12 VDC	regulated voltage for the RS232/485 converter	pink
		shield	

W3 – Alarm, Trigger, 6-pin

Description		Color (6 wires)	
1	Relay contact	Potential free relay contact, capacity max. 30 V, 1 A.	brown
2	Relay contact	Potential free relay contact, capacity max. 30 V, 1 A	white
3	Trigger +	Trigger input: + 5 to + 24 VDC	green
4	Trigger -	Trigger input GND	yellow
5	Functional input	Not used	pink
6	Functional input	Not used	gray
		shield	black

Drawings

12.4 Fibre Optic Converter Box Wiring

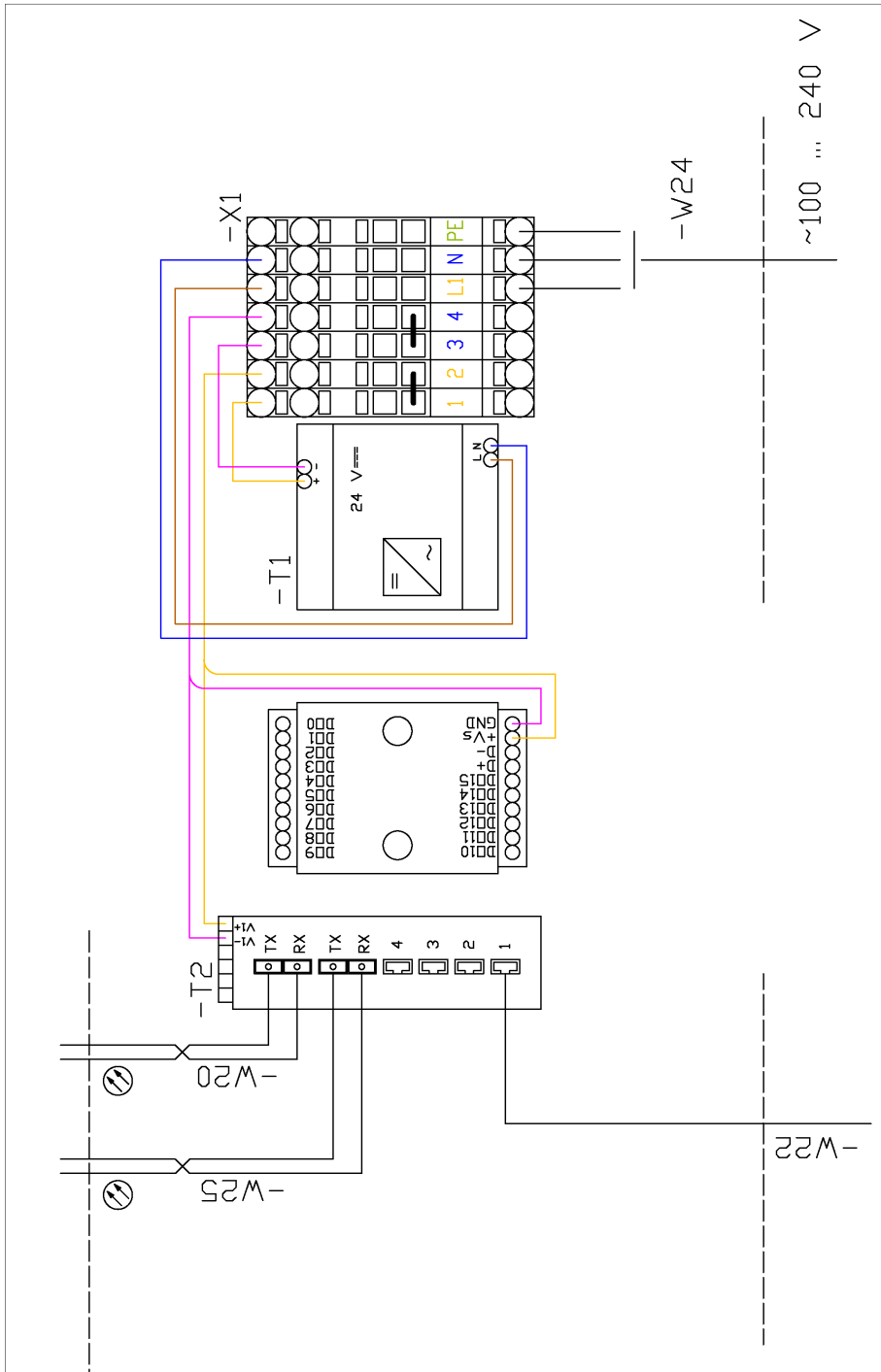

12.5 Position Indicator Wiring



The W8 cable for the position indicator is only to be wired to the system connection box like shown below for the standard CS210 system! In case of using the LRM accessory the position indicator is connected to the LRM connection box in the field directly!

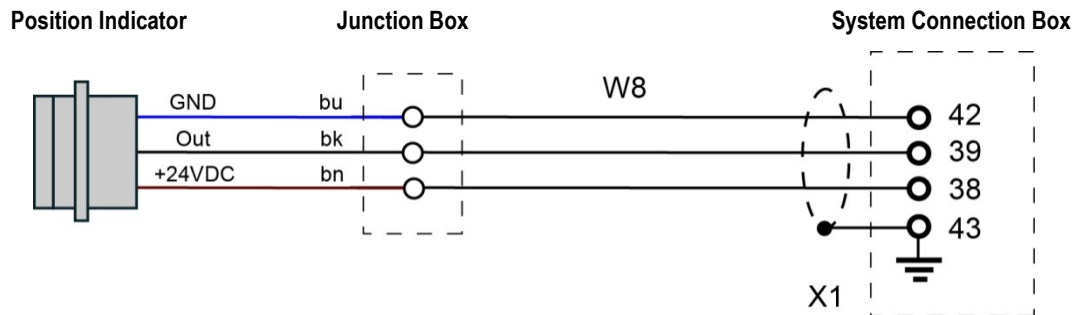

Drawings

12.6 Fan Control Wiring

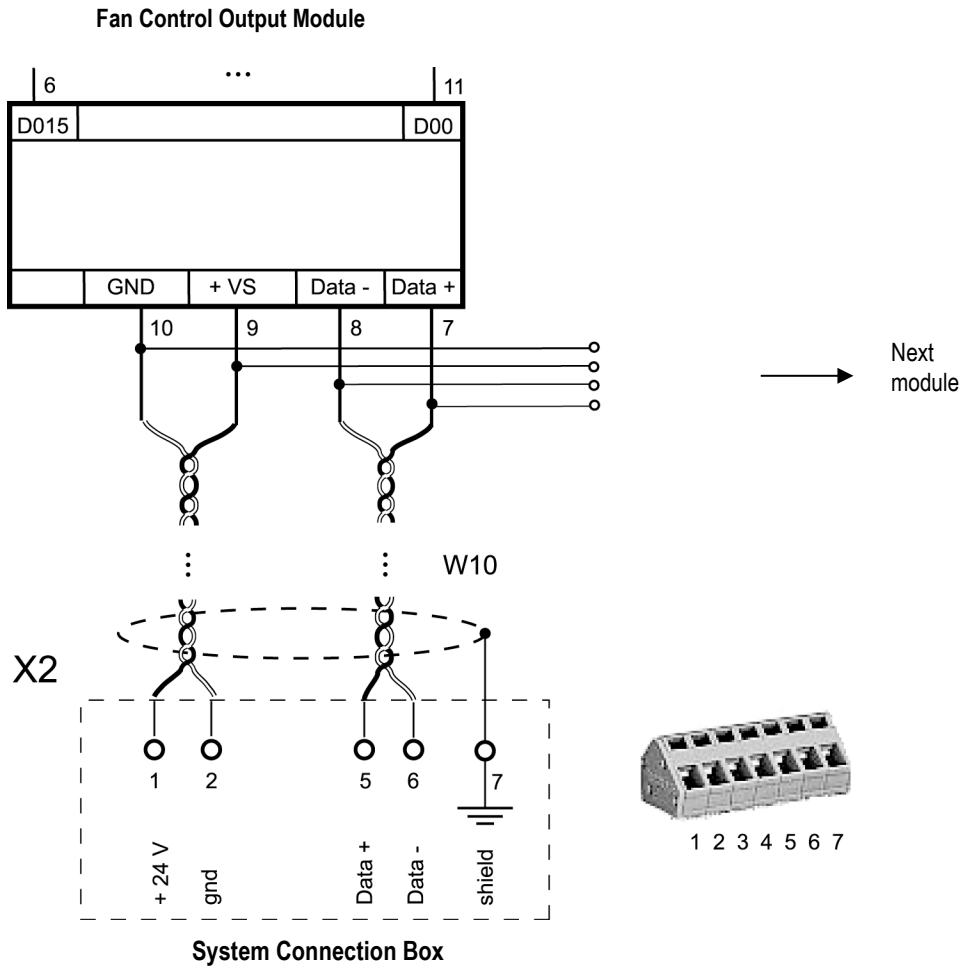

12.7 LRM Wiring

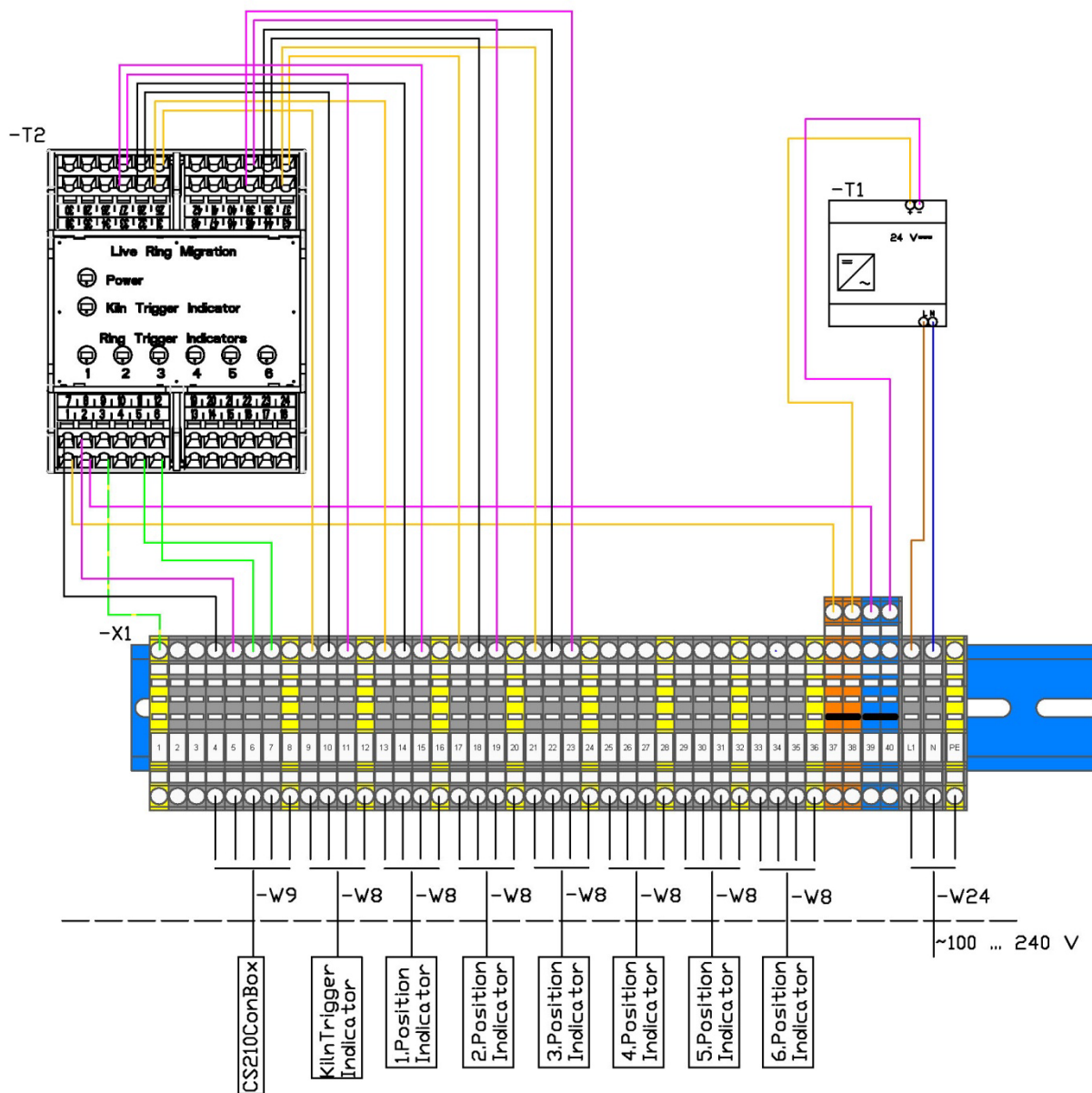

Figure 97:Wiring Scheme for LRM Remote Control Box

Drawings

12.7.1 Wiring W8

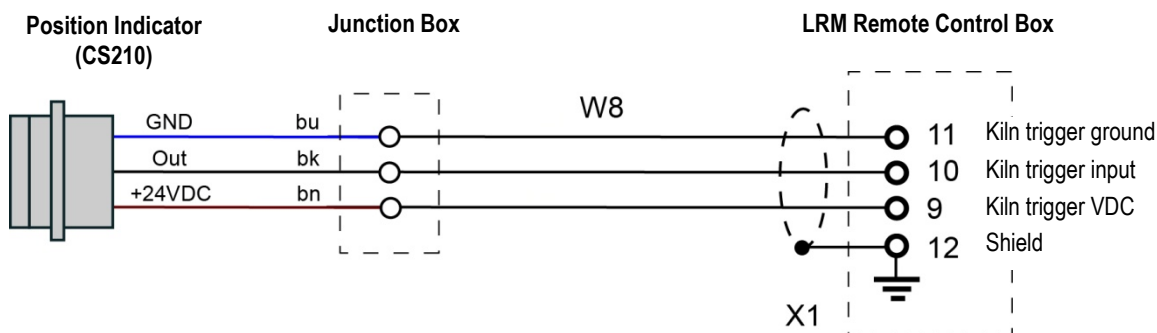

Figure 98: Wiring the Position Indicator for the Kiln Trigger

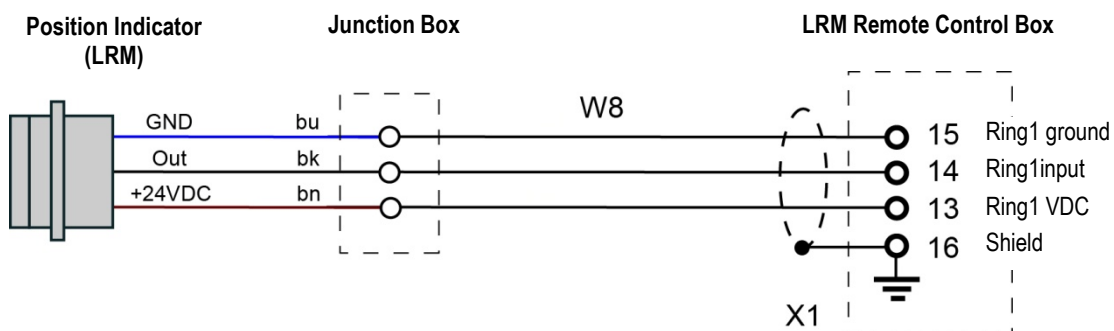

Figure 99: Wiring the Position Indicator for Ring1

W8 – Position Indicator Wiring, 4-pin

Position Indicator	Ring 1 Pin	Ring 2 Pin	Ring 3 Pin	Ring 4 Pin	Ring 5 Pin	Ring 6 Pin
Shield	16	20	24	28	32	36
+ 24 VDC	13	17	21	25	29	33
Out	14	18	22	26	30	34
GND	15	19	23	27	31	35

12.7.2 Wiring W9

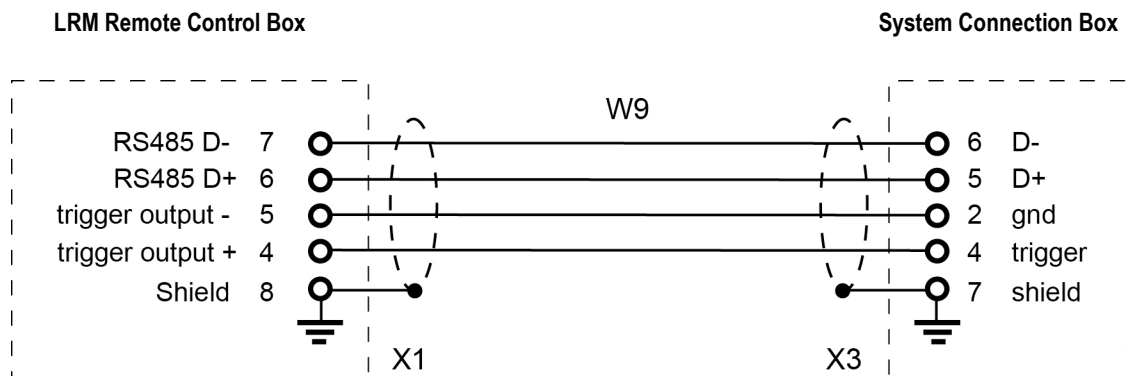
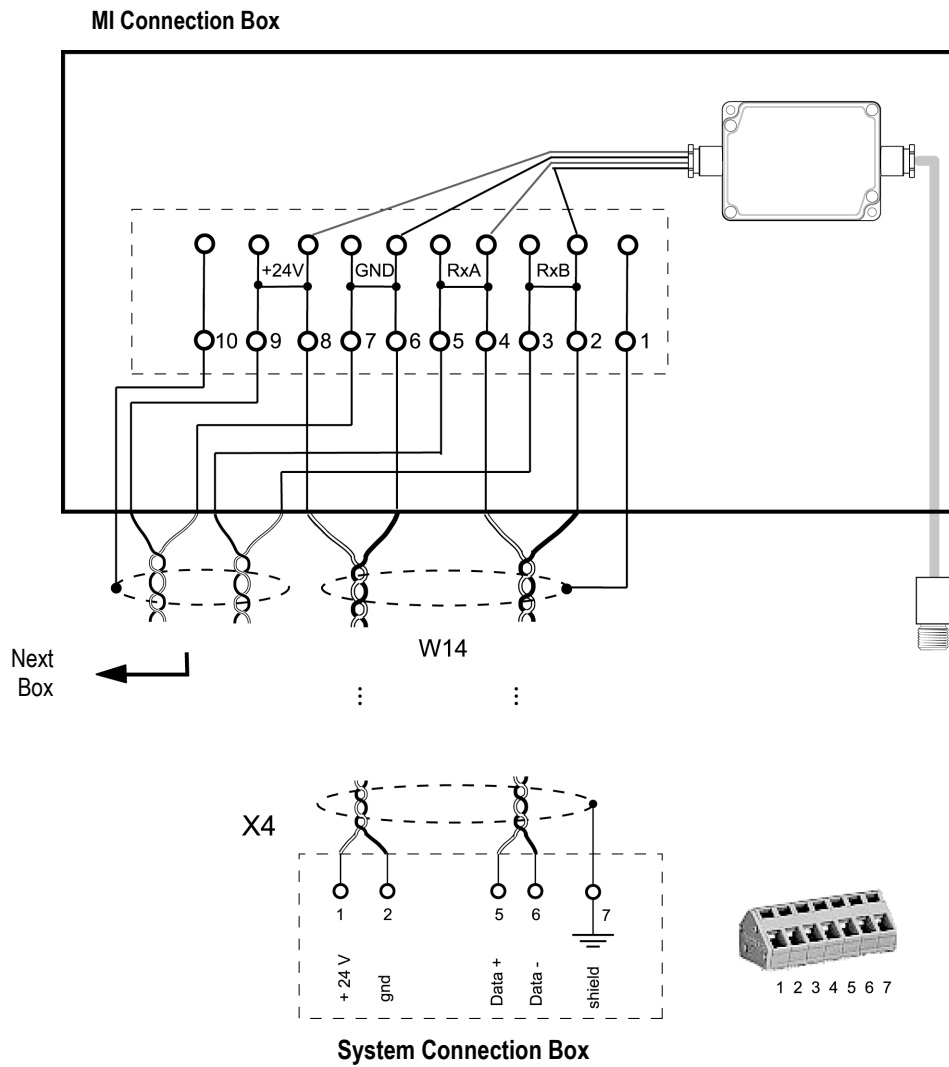

Figure 100: Wiring of W9 between LRM Remote Control Box and System Connection Box

Drawings

12.8 Shadow Monitoring Wiring



12.9 Burning Zone Wiring

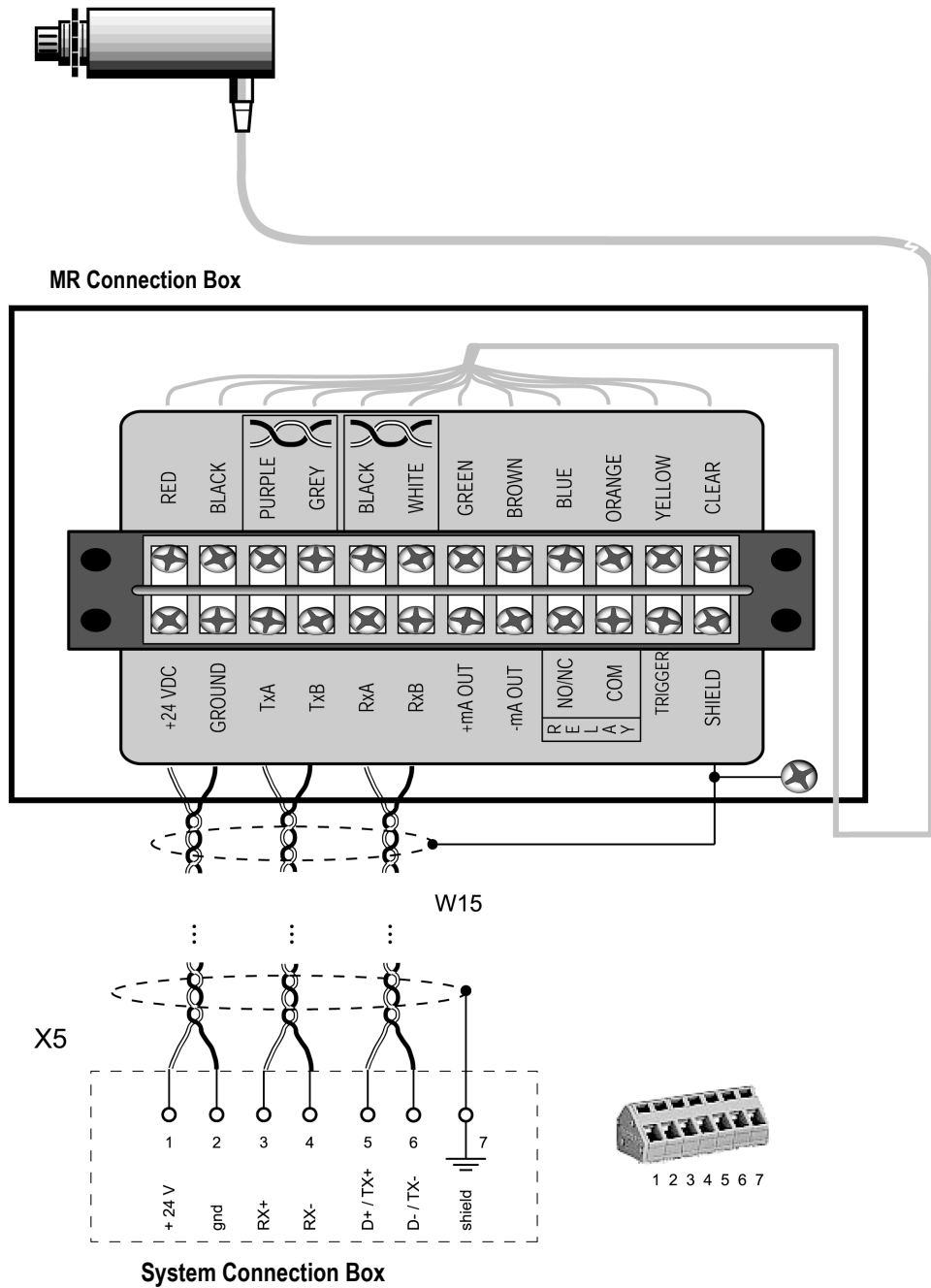

Appendix – Technical Data

13. Appendix – Technical Data

13.1 Protective Housing

To protect the linescanner from the high temperatures and poor air quality near the kiln, the scanner is enclosed in a rugged stainless steel protective housing. Air purging and/or water-cooling is available, if required (CS212 system - contains two protective housings).

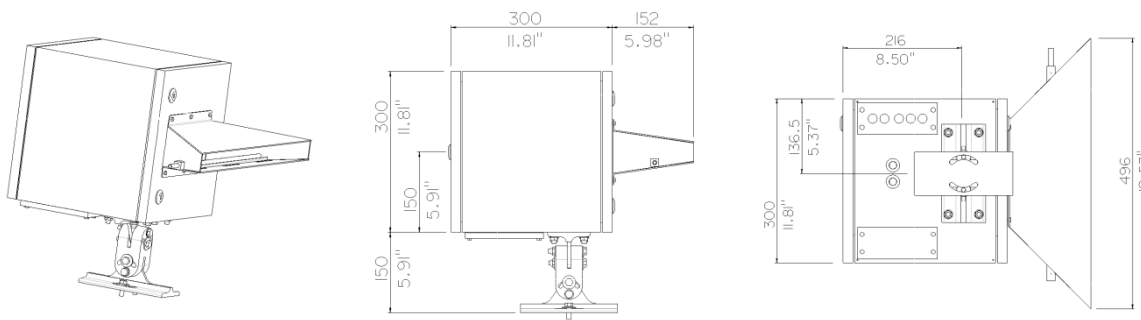

Part No.	Description
XXXSYSPHSS	Linescanner Protective Housing with quick-release rail mounted scanning system
Material:	
Box	Stainless Steel 1.4301
Seal	EPDM, CR
Mounting Bracket	galvanized steel
Dimensions (h x w x d)	300 x 300 x 300 mm (11.81 x 11.81 x 11.81 in.)
- with mounting frame	height is about 450 mm (17.72 in.)
Weight	about 20 kg (44 lb), linescanner included
Protection rate	IP54
Window transmission	0.9
Air purge:	
Connector	outer diameter 8 mm (0.315 in.)
Pressure	1.5 to 3 bar (air must be cleaned)
Scope of delivery:	
	stainless steel box with air purge and all mounting parts
	adjustable mounting bracket allowing aiming along any axis
	grommets and grommet plate
	spare removable window
Options:	
	air – water heat exchanger

13.2 Connection Box

The connection box is used for the following two items:

- XXXCS210CONBOX System connection box in the field
- XXXHSFICBOX Fibre Optic Converter Box in the control room

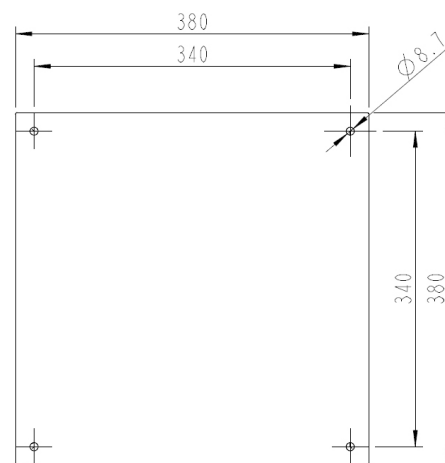
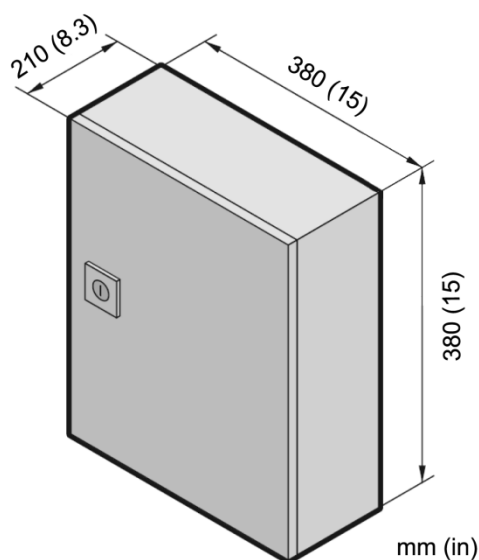

Technical Data:

Box	sheet steel, powder-coated
Temperature Range	0 to 50°C (32 to 122°F) -30°C (-22°F) with internal heater XXXSYSCONNBOXHEAT for the system connection box (XXXCS210CONBOX)
Dimensions (W x H x D)	380 x 380 x 210 mm (15 x 15 x 8.3 in)
Net Weight	approx. 12 kg (26 lb)
Protection Rate:	IP66 (NEMA 4)
Power supply	100 to 240 VAC, 50/60 Hz
Wiring	cable diameter max. 2.5 mm ² (AWG 14)
Power input	max. 110 W (for the system connection box XXXCS210CONBOX) max. 30 W (for the fibre optic converter box XXXHSFICBOX)
Fuse	6 A (fuse only with system connection box XXXCS210CONBOX)

Appendix – Technical Data

13.3 Fibre Optic / RJ45 Ethernet Converter

Ethernet Communications

Ports	4x
Port connector	RJ45
Distance	max. 90 m (295 ft)

Fibre Optic Communications

Ports	2x
Port connector	SC type
Fibre	multi-mode, 62.5/125 μm or 50/125 μm
Distance	max. 2 km (1.24 mi)

Mechanics

Dimensions (W x H x D)	37 x 140 x 95 mm (1.45 x 5.5 x 3.7 in)
Mounting	DIN-rail

Power

Power input	12 to 48 VDC, redundant dual inputs
Power connector	removable screw terminal
Power consumption	6.5 W

Environment

Operating temperature	-10 to 60°C (14 to 140°F)
Storage temperature	-40 to 85°C (-40 to 185°F)
Operating humidity	5 to 95% RH
Protection	4.000 V _{DC} ESD (Ethernet), 3.000 V _{DC} Surge (EFT for power)

13.4 Connection Box for Accessories

The connection box connects the cables of a field device (shadow pyrometer, burning zone pyrometer, or LRM) with the customer cables in the field.

All connection boxes come with the same housing but have different internal electrical wiring.

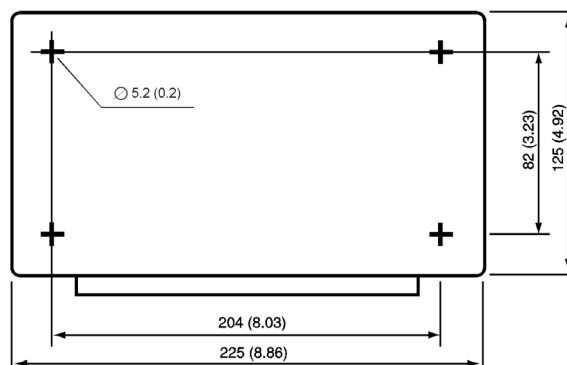

Part No.	Description
XXXCS200MRCON	MR connection box (for Burning Zone Monitoring)
XXXCS200MICON	MI connection box (for Shadow Monitoring)
XXXTCSLRMRC	LRM connection box (for Live Ring Migration)
Technical Data:	
Box	Aluminum die cast
Cable Grommet Plate	Polyamide, halogen free and thermoplastic rubber
Temperature Range	-40 to +80°C (-40°F to 168°F)
Dimensions (h x w x d)	90 x 225 x 130 mm (3.54 x 8.85 x 5.11 in.)
Weight	1.8 kg (3.96 lb)
Protection Rate:	IP65 (NEMA 4)
Delivery:	
	Connection Box
	Cable grommet plate
	Set of grommets for different cable sizes

Appendix – Technical Data

13.5 Position Indicator

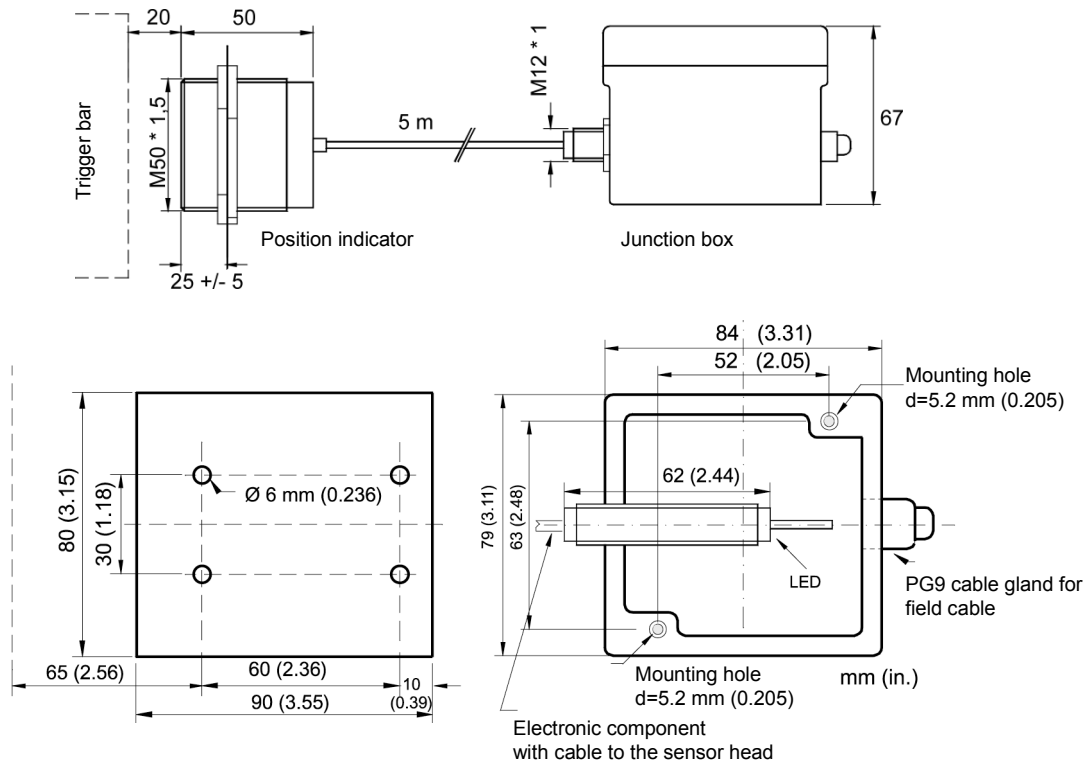

Figure 101: Dimensions of Position Indicator and Junction Box

XXXSYSECPI	<p>Position indicator, proximity switch for synchronizing process and program</p> <ul style="list-style-type: none"> - tough design - high switch distance - max. ambient temperature range: -25 to 230°C (-13 to 446°F) - simple mounting with mounting plate - separate junction box
Switching distance	<p>max. 20 mm (0.79 in.)</p> <p>positioned to steel St37 , sized 50 mm in square (2.16 in. in square)</p>
Temperature range	<p>position indicator: -25 to 230°C (-13 to 446°F)</p> <p>junction box: -25 to 70°C (-13 to 158°F)</p>
Protection rate	IP67
Length of cable	5 m (15 ft)
Output	<p>No. 2: active 24 V / 300 mA max.</p> <p>short circuit protected</p>
Junction Box	<p>Pin 2 (brown cable): + 24 VDC (7 to 40 VDC), ripple max. 15 %</p> <p>Pin 3 (black cable): output active</p> <p>Pin 1 (blue cable): 0 V</p>

13.6 Output Modules

Dimensions (W x L x H)

72 x 122 x 25 mm (2.8 x 4.8 x 1 in.)

13.6.1 Digital Output Module 7043 (16 channels)

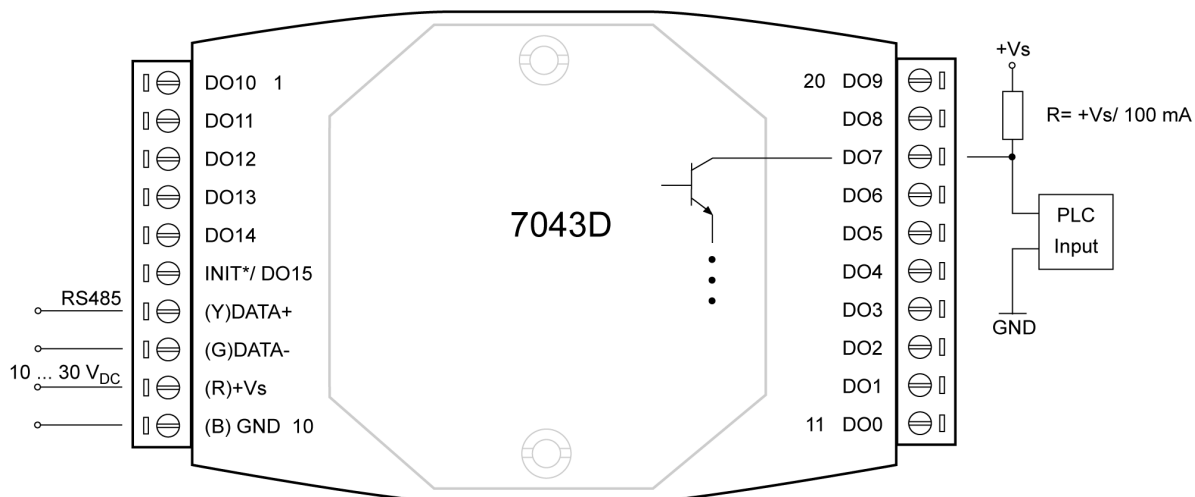

Figure 102: Wiring Example for connection to a PLC

13.6.2 Relay Output Module 7067 (7 channels)

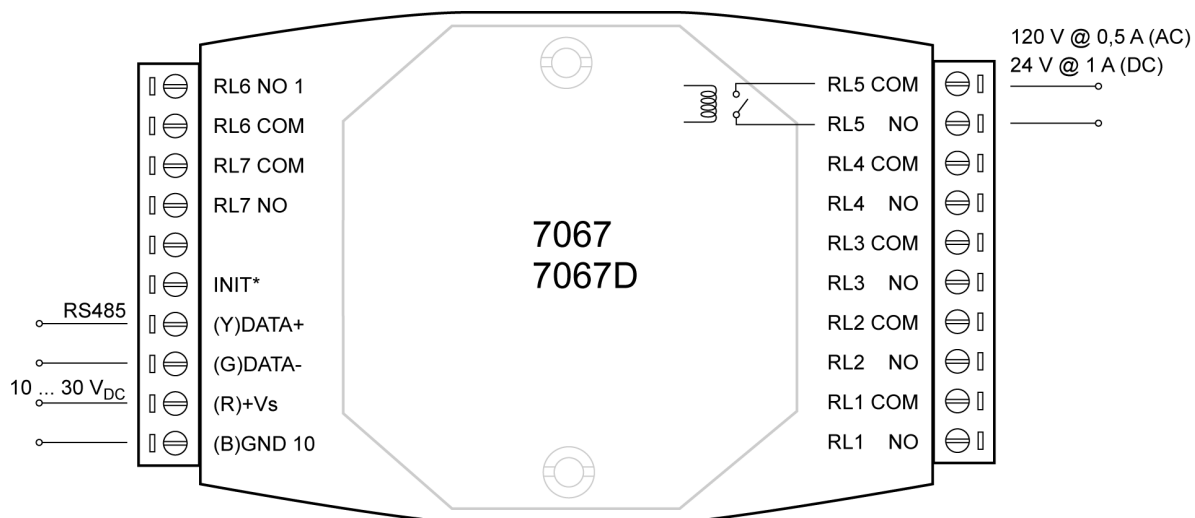

Figure 103: Wiring the 7067 Module

Notes

14. Notes