

## Standard Rectifier Module

1~ Rectifier	
$V_{RRM}$	= 1600 V
$I_{DAV}$	= 45 A
$I_{FSM}$	= 750 A

### 1~ Rectifier Bridge

Part number

VBO50-16NO7

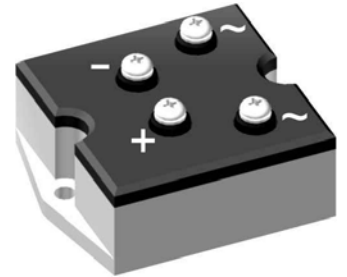

 E72873

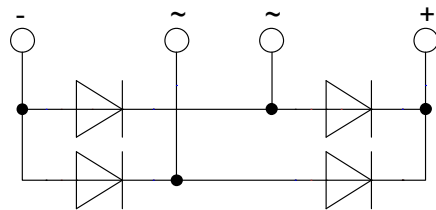

#### Features / Advantages:

- Package with DCB ceramic
- Improved temperature and power cycling
- Planar passivated chips
- Very low forward voltage drop
- Very low leakage current

#### Applications:

- Diode for main rectification
- For one phase bridge configurations
- Supplies for DC power equipment
- Input rectifiers for PWM inverter
- Battery DC power supplies
- Field supply for DC motors

#### Package: PWS-B

- Industry standard outline
- RoHS compliant
- Easy to mount with two screws
- Base plate: Aluminium internally DCB isolated
- Advanced power cycling

Rectifier				Ratings			
Symbol	Definition	Conditions		min.	typ.	max.	Unit
$V_{RSM}$	max. non-repetitive reverse blocking voltage					1700	V
$V_{RRM}$	max. repetitive reverse blocking voltage					1600	V
$I_R$	reverse current	$V_R = 1600$ V	$T_{VJ} = 25^\circ\text{C}$			100	$\mu\text{A}$
		$V_R = 1600$ V	$T_{VJ} = 150^\circ\text{C}$			1.5	mA
$V_F$	forward voltage drop	$I_F = 20$ A	$T_{VJ} = 25^\circ\text{C}$			1.03	V
						1.14	V
		$I_F = 40$ A	$T_{VJ} = 125^\circ\text{C}$			0.92	V
						1.06	V
$I_{DAV}$	bridge output current	$T_C = 85^\circ\text{C}$ rectangular	$T_{VJ} = 150^\circ\text{C}$			45	A
$V_{FO}$	threshold voltage					0.76	V
$r_F$	slope resistance					6.9	m $\Omega$
$R_{thJC}$	thermal resistance junction to case					2.7	K/W
$R_{thCH}$	thermal resistance case to heatsink				0.4		K/W
$P_{tot}$	total power dissipation			$T_C = 25^\circ\text{C}$		46	W
$I_{FSM}$	max. forward surge current	t = 10 ms; (50 Hz), sine	$T_{VJ} = 45^\circ\text{C}$			750	A
						t = 8,3 ms; (60 Hz), sine	$V_R = 0$ V
		t = 10 ms; (50 Hz), sine	$T_{VJ} = 150^\circ\text{C}$			640	A
						t = 8,3 ms; (60 Hz), sine	$V_R = 0$ V
$I^2t$	value for fusing	t = 10 ms; (50 Hz), sine	$T_{VJ} = 45^\circ\text{C}$			2.82	kA <sup>2</sup> s
						t = 8,3 ms; (60 Hz), sine	$V_R = 0$ V
		t = 10 ms; (50 Hz), sine	$T_{VJ} = 150^\circ\text{C}$			2.05	kA <sup>2</sup> s
						t = 8,3 ms; (60 Hz), sine	$V_R = 0$ V
$C_J$	junction capacitance	$V_R = 400$ V; f = 1 MHz		$T_{VJ} = 25^\circ\text{C}$		10	pF

Package PWS-B			Ratings			
Symbol	Definition	Conditions	min.	typ.	max.	Unit
$I_{RMS}$	RMS current	per terminal			100	A
$T_{stg}$	storage temperature		-40		125	°C
$T_{VJ}$	virtual junction temperature		-40		150	°C
<b>Weight</b>				193		g
$M_D$	mounting torque		4.25		5.75	Nm
$M_T$	terminal torque		2.5		3.5	Nm
$d_{Spp/App}$	creepage distance on surface   striking distance through air	terminal to terminal	11.0			mm
$d_{Spb/Appb}$		terminal to backside	7.5			mm
$V_{ISOL}$	isolation voltage	t = 1 second	3000			V
		t = 1 minute	2500			V

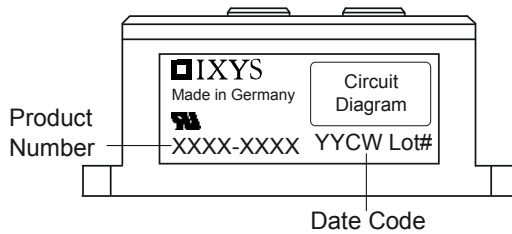

Ordering	Part Number	Marking on Product	Delivery Mode	Quantity	Code No.
Standard	VBO50-16NO7	VBO50-16NO7	Box	10	472271

### Equivalent Circuits for Simulation

\* on die level

$T_{VJ} = 150\text{ °C}$



Rectifier

$V_{0\ max}$	threshold voltage	0.76	V
$R_{0\ max}$	slope resistance *	5.7	mΩ

**Outlines PWS-B**

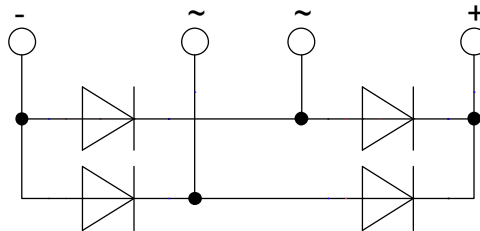
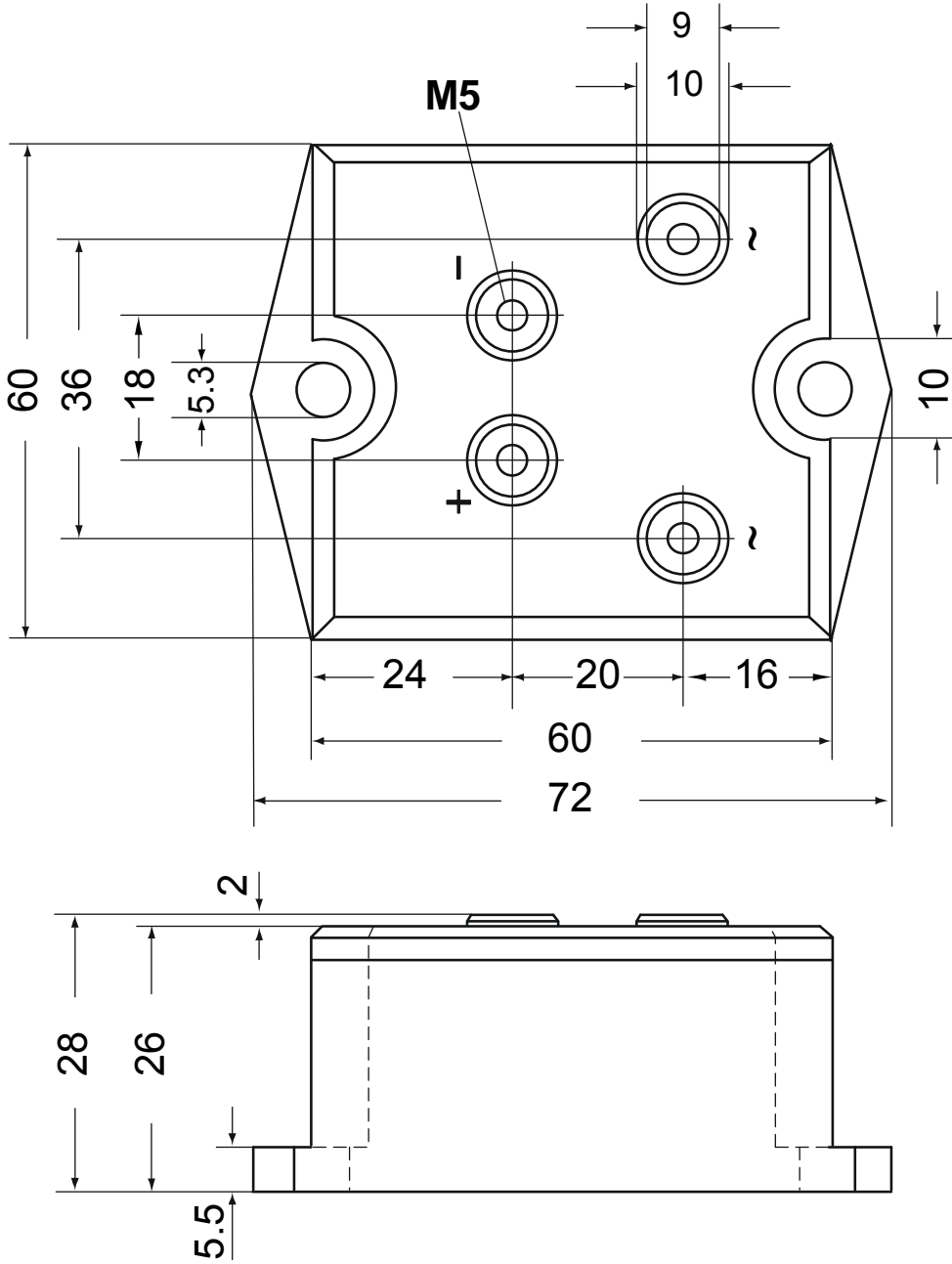

Rectifier

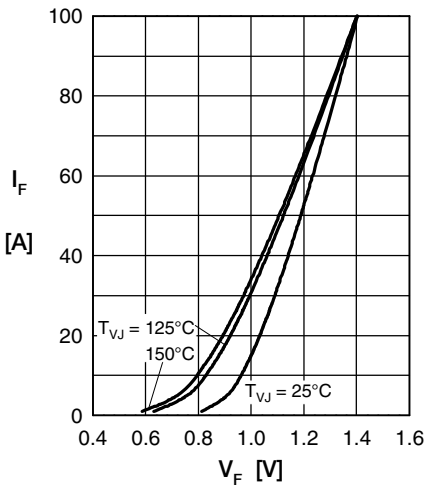

Fig. 1 Forward current vs. voltage drop per diode

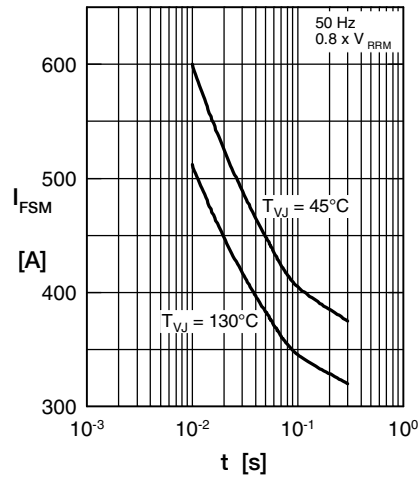

Fig. 2 Surge overload current vs. time per diode

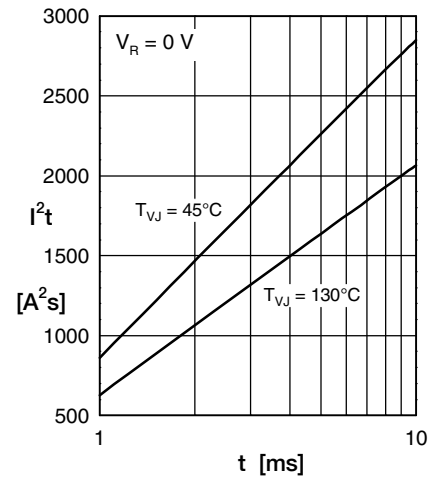

Fig. 3 I<sup>2</sup>t vs. time per diode

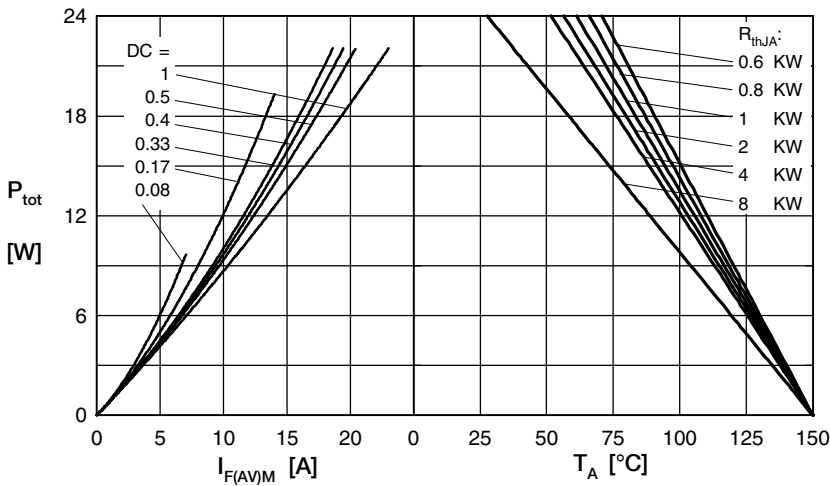

Fig. 4 Power dissipation vs. forward current and ambient temperature per diode

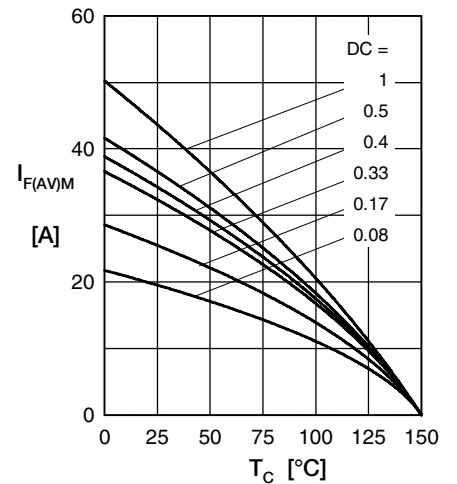

Fig. 5 Max. forward current vs. case temperature per diode

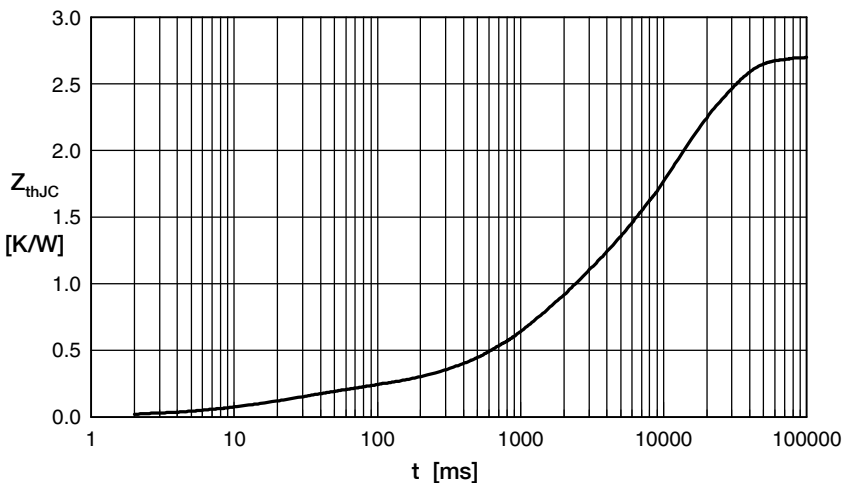

Fig. 6 Transient thermal impedance junction to case vs. time per diode

Constants for  $Z_{thJC}$  calculation:

i	$R_{th}$ (K/W)	$t_i$ (s)
1	0.040	0.010
2	0.150	0.030
3	0.610	1.350
4	1.900	14.00