

## Content

### **Time delay relays pluggable**

Multifunctional time delay relay MFT SU22S, MFT SU22P .....	2.2
Multifunctional time delay relay MFT SU31S optional with instantaneous contact .....	2.6
Multifunctional time delay relay MFT SU41SE with external potentiometer .....	2.12
Multifunctional clock-pulse generator relay MFT ST22S .....	2.18
Multifunctional clock-pulse generator relay MFT ST51SE with external potentiometer .....	2.22
Delay off without supply voltage MFT SA23S .....	2.26
Star-delta relay MFT SS22S .....	2.30
Accessories time delay relays .....	2.34
Plug in socket .....	2.34
External potentiometer .....	2.34
Technical safety advice .....	2.35
Prescriptions and standards .....	2.36

## Multifunctional time delay relay

MFT SU22S, MFT SU22P



MFT SU22S

- **7 Functions, 7 time ranges**
- **Multivoltage:**  
**12 ... 240 Vac / dc**
- **2 output contacts**

### Functions

- E** Delay on
- E** Delay on - version with control contact as opening contact
- A** Delay off
- I2** Pulse extension with control contact
- W2** Wiping on trailing edge
- E1** Delay on with control contact
- I1** Pulse limitation timer voltage control
- B2** Cycling timer starting on a pause

### Time end ranges

Adjustment range 0,05 s ... 100 h

### Output relay

2 potential free change over contacts  
250 Vac 8 A

### Indicators

- Green LED ON: indication of supply voltage
- Green LED flashes: indication of time
- Yellow LED ON/OFF: indication of relay output

### Connecting voltage

12 ... 240 Vac/dc -10% +10%  
48 ... 63 Hz, 100% duration of operation, IEC class 1c



MFT SU22P

### Reference data

Selectron® MFT	Article no.
MFT SU22S	41140010
MFT SU22P	41140012
(Order data see chapter 1)	

# Multifunctional time delay relay

## MFT SU22S, MFT SU22P

Technical data	MFT SU22S	MFT SU22P
<b>Nominal consumption</b>		
12 ... 240 Vac/dc	6 VA / 2 W	
<b>Control contact / Voltage controlled</b>		
Parallel switching of loads possible	yes	no
Parallel minimum load	1 VA or 0,5 W	-
Voltage dependence:	The potential between connections 2 and 5 must cover 90% of the supply voltage	Potential free control contact between connections 6 and 7 The internal voltage on these connectors is on the same potential as supply voltage
Connecting length between connections 2 and 5:	10 m or capacity <10 nF	-
Connecting length between connections 6 and 7:	At 230 VAC 10 VDC <1 mA	10 m or capacity <10 nF
Resistance	>1 MΩ (contact K2 open)	-
Rest current at parallel load:	approx. 2 mA at contact K2 open	-
<b>Accuracy</b>		
Base accuracy	±1% of scale limit	
Repetition accuracy	<5 ms or <0,5%	
Adjustment accuracy	≤5% of scale limit	
Temperature influence	≤0,01% / °C	
Voltage influence		
<b>Reaction times</b>		
Operating return time K1	max. 60 ms / 30 ms	
Reaction time K2	max. 30 ms	
Min. pulse/pause time K2	ac 100 ms / dc 50 ms	
Recovery time	max. 100 ms	

### Type key

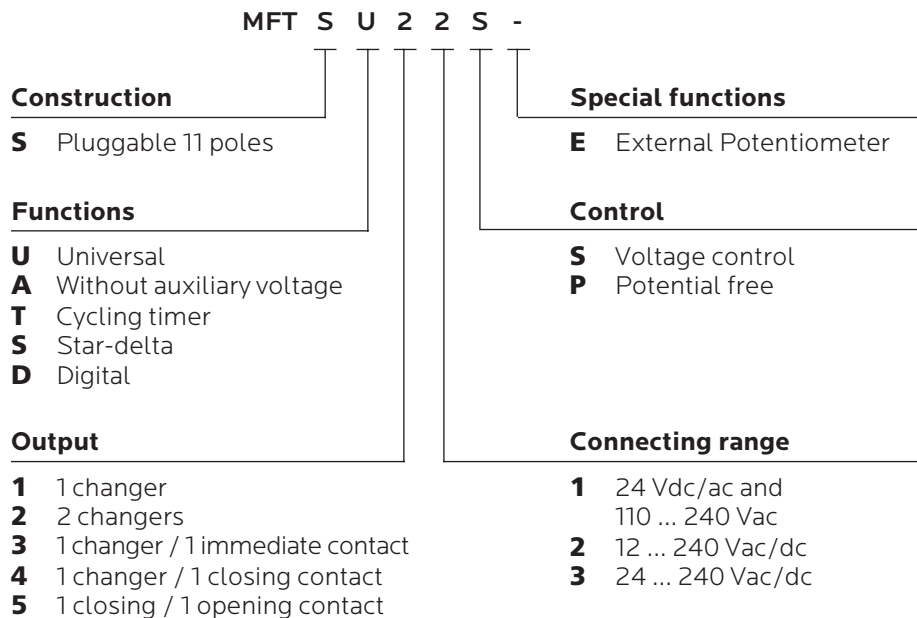

# Multifunctional time delay relay

MFT SU22S, MFT SU22P

## Function descriptions

### E - Delay on

When the supply voltage U (K1 closed) is applied, the set interval t begins (green LED U/t flashes). After the interval t



has expired (green LED U/t illuminated) the output relay switches into on-position (yellow LED illuminated). This status remains until the supply voltage U (K1 opened) is interrupted. If the supply voltage U is interrupted before expiry of the interval t, the interval already expired is erased and is restarted when the supply voltage U (K1 closed) is next applied.

### E - Delay on - version with control contact as opening contact

The supply voltage U must be constantly applied to the device (green LED U/t illuminated). When the control

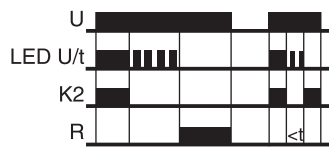

contact K2 is opened, the set interval t begins (green LED U/t flashes). After the interval t has expired the output relay switches into on-position (yellow LED illuminated). If the control contact K2 is closed before the interval t has expired, the interval already expired is erased and is restarted with the next cycle.

### A - Delay off

The supply voltage U (K1 closed or permanently connected) must be constantly applied to the device (green LED U/t

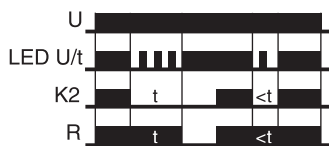

illuminated). When the control contact K2 is closed, the output relay R switches into on-position (yellow LED illuminated). If the control contact K2 is opened, the set interval t begins (green LED U/t flashes). After the interval t has expired (green LED U/t illuminated) the output relay switches into off-position (yellow LED not illuminated). If the control contact K2 is closed again before the interval t (green LED U/t illuminated) has expired, the interval already expired is erased and is restarted with the next cycle.

### I2 - Pulse extension with control contact

The supply voltage U (K1 closed or permanently connected) must be constantly applied to the device (green LED U/t

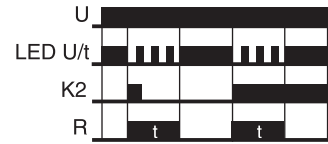

illuminated). When the control contact K2 is closed, the output relay R switches into on-position (yellow LED illuminated) and the set interval t begins (green LED U/t flashes). After the interval t has expired (green LED U/t illuminated) the output relay switches into off-position (yellow LED not illuminated). During the interval, the control contact K2 can be operated any number of times. A further cycle can only be started when the cycle run has been completed.

### W2 - Wiping on trailing edge

The supply voltage U (K1 closed or permanently connected) must be constantly applied to the device (green LED U/t

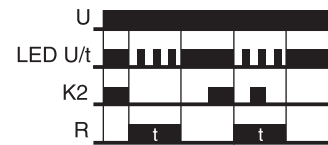

illuminated). Closing the control contact K2 has no influence on the condition of the output relay R. When the control contact K2 is opened, the output relay switches into on-position (yellow LED illuminated) and the set interval t begins (green LED U/t flashes). After the interval t has expired (green LED U/t illuminated), the output relay switches into off-position (yellow LED not illuminated). During the interval, the control contact K2 can be operated any number of times. A further cycle can only be started when a cycle run has been completed.

### E1 - Delay on with control contact

The supply voltage U (K1 closed or permanently connected) must be constantly applied to the device (green LED U/t

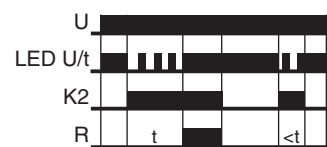

illuminated). When the control contact K2 is closed, the set interval t begins (green U/tLED flashes). After the interval t has expired (green LED U/t illuminated) the output relay R switches into on-position (yellow LED illuminated). This status remains until the control contact K2 is opened. If the control contact K2 is opened before the interval t has expired, the interval already expired is erased and is restarted with the next cycle.

# Multifunction time delay relay

MFT SU22S, MFT SU22P

## Function descriptions

### I1 - Pulse limitation timer voltage control

When supply voltage U (K1 closed) is applied, the output relay R switches into on-position (yellow LED illuminated)

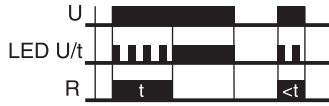

and the set interval t begins (green LED U/t flashes). After the interval t has expired (green LED U/t illuminated) the output relay switches into off-position (yellow LED not illuminated). This status remains until the supply voltage (K1 opened) is interrupted. If the supply voltage is interrupted before the interval t has expired, the output relay switches into off-position. The interval t already expired is erased and is restarted when the supply voltage is next applied.

### B2 - Cycling timer starting on a pause

When the supply voltage U is applied, the set interval t begins (green LED U/t flashes). After the interval t has

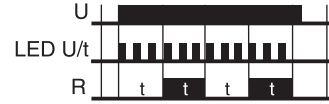

expired, the output relay R switches into on-position (yellow LED illuminated) and the set interval t begins again. After the interval t has expired, the output relay switches into off-position (yellow LED not illuminated). The output relay is triggered in the ratio 1:1 until the supply voltage is interrupted.

## Connection

### MFT SU22S

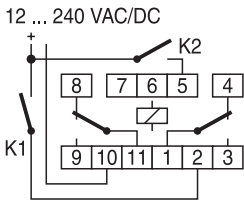

### MFT SU22P

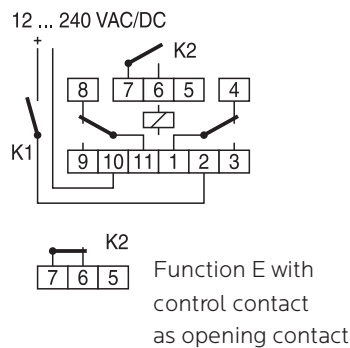

## Load limit curves

### MFT SU22S, MFT SU22P

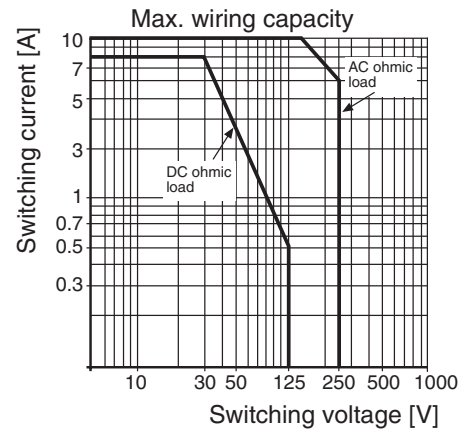

## Dimensions

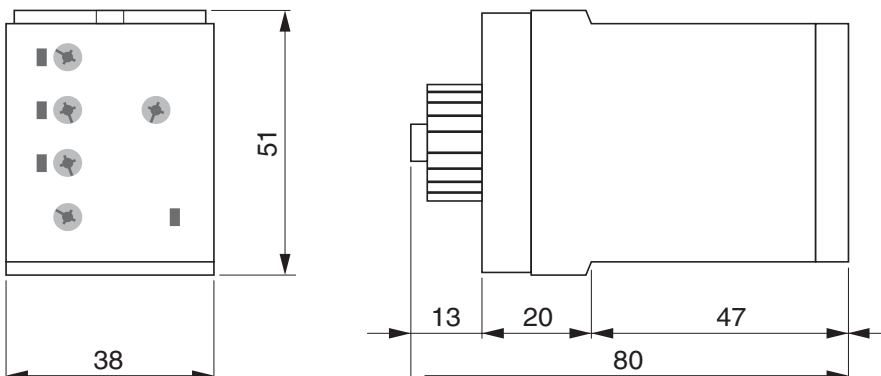

## Multifunctional time delay relay, optional with instantaneous contact

### MFT SU31S



MFT SU31S

- **14 Functions, 16 time ranges**
- **Multivoltage:**  
**24 VAC/DC and 110 ... 240 VAC**
- **2 output contacts**

#### Functions, optional with instantaneous contact

- E** Delay on
- A** Delay off
- E1** Delay on with control contact
- I1** Pulse limitation timer voltage control
- I2** Pulse extension with control contact
- W2** Wiping on trailing edge with control contact
- B2** Cycling timer starting on a pause

- 11** Immediate contact and delayed contact
- 20** Both contacts are delayed contacts

#### Time end ranges

Adjustment range 0,05 s ... 30 days (

#### Output relay

2 changes

250 Vac 5 A units close together, 8 A units not close together

#### Indicators

Green LED ON: indication of supply voltage

Green LED flashes: indication of time

Yellow LED ON/OFF: indication of relay output

#### Connecting voltage

24 VDC  $\pm 10\%$

24 VAC -15% ... +10%

110 ... 240 VAC -15% ... +10%

#### Reference data

Selectron® MFT	Article no.
MFT-SU31S	41140003
(Order data see chapter 1)	

# Multifunctional time delay relay, optional with instantaneous contact

MFT SU31S

Technical data	
<b>Nominal consumption</b>	
24 VAC/DC	0.8 VA / 0.6 W
110 VAC	2.5 VA / 0.7 W
240 VAC	20 VA / 1.0 W
<b>Control contact / Voltage controlled</b>	
Parallel switching of loads possible	
Parallel minimum load	1 VA or 0.5 W
Voltage dependence:	The potential between connections 2 and 5, resp. 7 and 5, must cover 90% of the supply voltage
Connecting length between connections 10 and 5:	10 m or capacity <10 nF
Resistance	>1 MΩ (contact K2 open)
Rest current at parallel load:	approx. 2 mA at contact K2 open
Control pulse length	DC min. 50 ms AC min.100 ms
<b>Accuracy</b>	
Base accuracy	±5% of scale limit
Repeatability	
of the scale limit at constant conditions	±5% or ±100 ms
Adjustment accuracy	<5% of scale limit
Temperature influence	≤0.05% / °C
<b>Reaction times</b>	
Operating return time K1	max. 60 ms / 30 ms
Reaction time K2	max. 30 ms
Min. pulse/pause time K2	AC 50 ms / DC 50 ms
Recovery time	max. 100 ms

## Type key

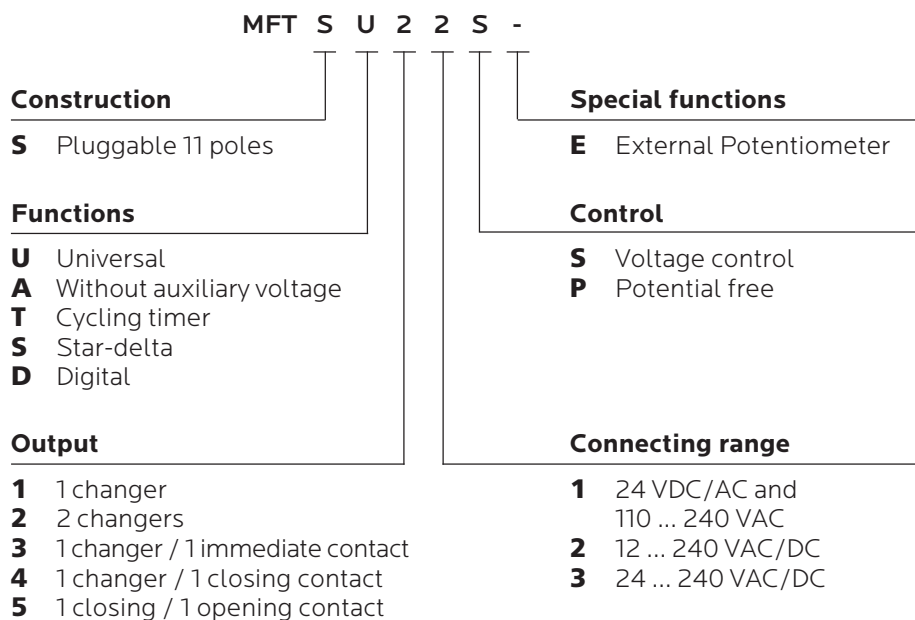

# Multifunctional time delay relay, optional with instantaneous contact

MFT SU31S

## Function descriptions

### E-11 - Delay on

When the supply voltage U (K1 closed) is applied, the instantaneous contact switches into on-position and

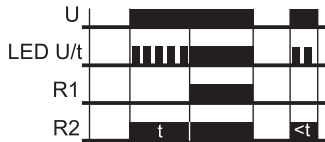

the set interval  $t$  begins (green LED U/t flashes). After the interval  $t$  has expired (green LED U/t illuminated) the delayed contact switches into on-position (yellow LED R illuminated).

This status remains until the supply voltage is interrupted. If the supply voltage is interrupted before the expiry of the interval  $t$ , the interval already expired is erased and is restarted when the supply voltage is next applied.

### A-11 - Delay off

The supply voltage U (K1 closed) must be constantly applied to the device (green LED U/t illuminated). When the control contact K2 is closed, both contacts switch into

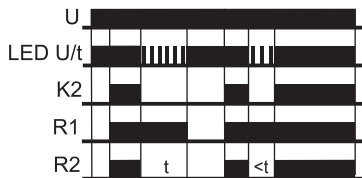

on-position (yellow LED R illuminated). If the control contact is opened, the instantaneous contact switches into off-position and the set interval  $t$  begins (green LED U/t flashes). After the interval  $t$  has expired (green LED U/t illuminated) the delayed contact switches into off-position (yellow LED R not illuminated). If the control contact is closed again before the interval  $t$  has expired, the interval already expired is erased and is restarted with the next cycle.

### E1-11 - Delay on with control contact

The supply voltage U (K1 closed) must be constantly applied to the device (green LED U/t illuminated).

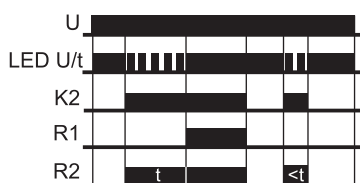

When the control contact K2 is closed, the instantaneous contact switches into on-position and the set interval  $t$  begins (green LED U/t flashes). After

the interval  $t$  has expired (green LED U/t illuminated) the delayed contact switches into on-position (yellow LED R illuminated).

This status remains until the control contact is opened again. If the control contact is opened before the interval  $t$  has expired, the interval already expired is erased and is restarted with the next cycle.

### I1-11 - Pulse limitation timer voltage control

When the supply voltage U (K1 closed) is applied, both contacts switch into on-position (yellow LED R

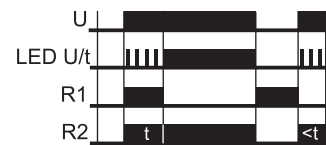

illuminated) and the set interval  $t$  begins (green LED U/t flashes). After the interval  $t$  has expired (green LED U/t illuminated) the delayed contact switches into off-position (yellow LED R not illuminated). This status remains until the supply voltage is interrupted.

If the supply voltage is interrupted before the interval  $t$  has expired, both contacts switch into off-position. The interval already expired is erased and is restarted when the supply voltage is next applied.

### I2-11 - Pulse extension with control contact

The supply voltage U (K1 closed) must be constantly applied to the device (green U/t LED illuminated).

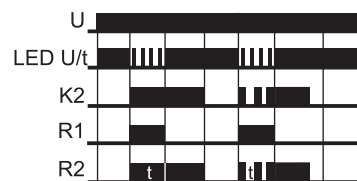

When the control contact K2 is closed, both contacts switch into on-position (yellow LED R illuminated) and the set interval  $t$  begins (green LED U/t flashes). After the interval  $t$  has expired (green LED U/t illuminated) the delayed contact switches into off-position (yellow LED R not illuminated). The instantaneous contact remains in on-position, until the control contact is opened again. During the interval, the control contact (and the instantaneous contact) can be operated any number of times. A further cycle can only be started when the cycle run has been completed.



# Multifunctional time delay relay, optional with instantaneous contact

MFT SU31S

## Function descriptions

### W2-11 - Wiping on trailing edge with control contact

The supply voltage U (K1 closed) must be constantly applied to the device (green LED U/t illuminated).

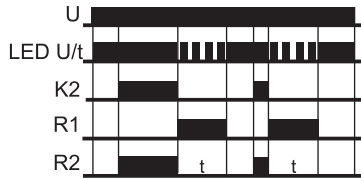

When the control contact K2 is closed the instantaneous contact switches into on-position. When the control contact K2 is opened, the instantaneous contact switches into off-position, the delayed contact switches into on-position (yellow LED R illuminated) and the set interval t begins (green LED U/t flashes). After the interval t has expired (green LED U/t illuminated), the delayed contact switches into off-position (yellow LED R not illuminated). During the interval, the control contact (and the instantaneous contact) can be operated any number of times. A further cycle can only be started when the cycle run has been completed.

### B2-11 - Cycling timer starting on a pause

When the supply voltage U (K1 closed) is applied, the instantaneous contact switches into on-position and

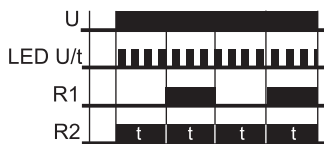

the set interval t begins (green LED U/t flashes). After the interval t has expired, the delayed contact switches into on-position (yellow LED R illuminated) and the set interval t begins again. After the interval t has expired, the delayed contact switches into off-position (yellow LED R not illuminated). The delayed contact is triggered at a ratio of 1:1 until the supply voltage is interrupted.

### E-20 - Delay on

When the supply voltage U (K1 closed) is applied, the set interval t begins (green LED U/t flashes). After the

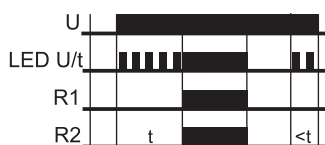

interval t has expired (green LED U/t illuminated) the output relays switch into on-position (yellow LED R

illuminated).

This status remains until the supply voltage is interrupted. If the supply voltage is interrupted before the expiry of the interval t, the interval already expired is erased and is restarted when the supply voltage is next applied.

### A-20 - Delay off

The supply voltage U (K1 closed) must be constantly applied to the device (green LED U/t illuminated).

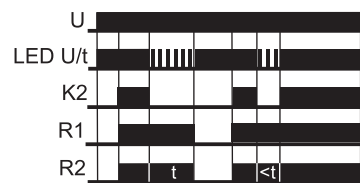

When the control contact K2 is closed, the output relays switch into on-position (yellow LED R illuminated). If the control contact is opened, the set interval t begins (green LED U/t flashes). After the interval t has expired (green LED U/t illuminated) the output relays switch into off-position (yellow LED R not illuminated). If the control contact is closed again before the interval t has expired, the interval already expired is erased and is restarted with the next cycle.

### E1-20 - Delay on with control contact

The supply voltage U (K1 closed) must be constantly applied to the device (green LED U/t illuminated).

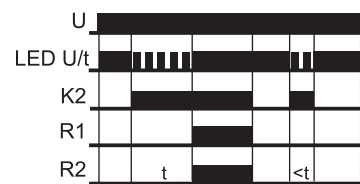

When the control contact K2 is closed, the set interval t begins (green LED U/t flashes). After the interval t has expired (green LED U/t illuminated) the output relays switch into on-position (yellow LED R illuminated). This status remains until the control contact is opened again. If the control contact is opened before the interval t has expired, the interval already expired is erased and is restarted with the next cycle.

# Multifunctional time delay relay, optional with instantaneous contact

MFT SU31S,

## Function descriptions

### I1-20 - Wiping on leading edge voltage control

When the supply voltage U (K1 closed) is applied, the output relays switch into on-position (yellow LED R

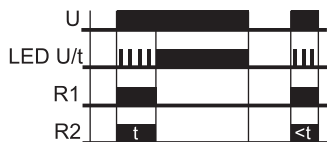

illuminated) and the set interval t begins (green LED U/t flashes). After the interval t has expired (green LED U/t illuminated) the output relays switch into off-position (yellow LED R not illuminated). This status remains until the supply voltage is interrupted. If the supply voltage is interrupted before the interval t has expired, the output relays switch into off-position. The interval already expired is erased and is restarted when the supply voltage is next applied.

### I2-20 - Wiping on leading edge with control contact

The supply voltage U (K1 closed) must be constantly

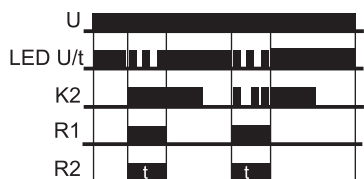

applied to the device (green LED U/t illuminated). When the control contact K2 is closed, the output relays switch into on-position (yellow LED R illuminated) and the set interval t begins (green LED U/t flashes). After the interval t has expired (green LED U/t illuminated) the output relays switch into off-position (yellow LED R not illuminated). During the interval, the control contact can be operated any number of times. A further cycle can only be started when the cycle run has been completed.

### W2-20 - Wiping on a trailing edge with control contact

The supply voltage U (K1 closed) must be constantly

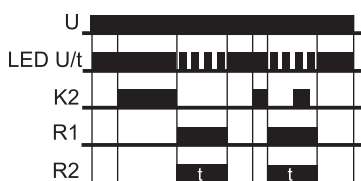

applied to the device (green LED U/t illuminated). Closing the control contact K2 has no influence on the

condition of the output relays. When the control contact is opened, the output relays switch into on-position (yellow LED R illuminated) and the set interval t begins (green LED U/t flashes). After the interval t has expired (green LED U/t illuminated), the output relays switch into off-position (yellow LED R not illuminated). During the interval, the control contact can be operated any number of times. A further cycle can only be started when the cycle run has been completed.

### B2-20 - Cycling timer starting on a pause

When the supply voltage U (K1 closed) is applied, the set interval t begins (green LED U/t flashes). After the

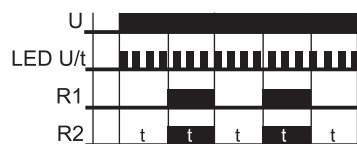

interval t has expired, the output relays switch into on-position (yellow LED R illuminated) and the set interval t begins again. After the interval t has expired, the output relays switch into off-position (yellow LED R not illuminated). The output relays are triggered at a ratio of 1:1 until the supply voltage is interrupted.

# Multifunctional time delay relay, optional with instantaneous contact

## MFT SU31S

### Connection

#### MFT SU31S

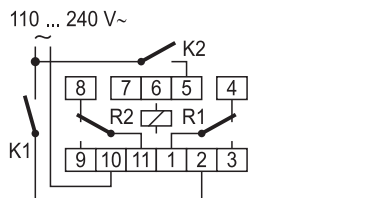

**11** R1= R2 Instantaneous-contact

**20** R1=R2=

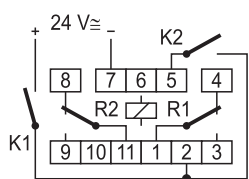

**11** R1= R2 Instantaneous-contact

**20** R1=R2=

### Load limit curves

#### MFT SU31S

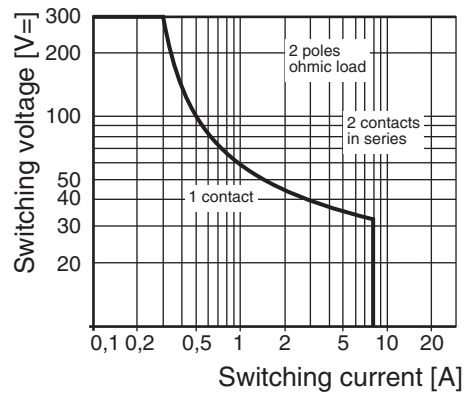

### Dimensions

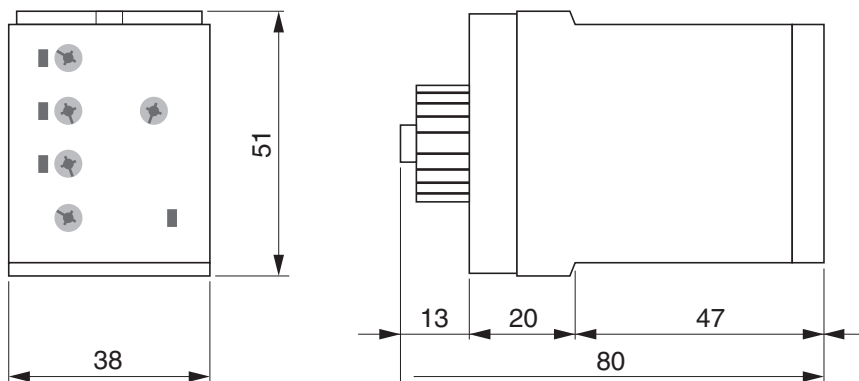

# Multifunction time delay relay with external potentiometer

## MFT SU41SE



MFT SU41SE

- **7 Functions, 7 time ranges**
- **Multivoltage:**  
**24 VAC/DC**  
**110 ... 240 VAC**
- **2 output contacts**

### Functions

- E** Delay on
- A** Delay off without auxiliary voltage
- E1** Delay on with control contact
- I1** Pulse limitation timer voltage control
- I2** Pulse extension with control contact
- W2** Wiping on trailing edge
- B2** Cycling timer starting on a pause

### Time end ranges

Adjustment range 0,05 s ... 100 h

### Output relay

1 change over and 1 closing contact potential free  
250 Vac 5 A units close together, 8 A units not close together

### Indicators

- Green LED ON: indication of supply voltage
- Green LED flashes: indication of time
- Yellow LED ON/OFF: indication of relay output

### Connecting voltage

- 24 VDC  $\pm 10\%$
- 24 VAC -15% ... +10%
- 110 ... 240 VAC -15% ... +10%

### Reference data

Selectron® MFT	Article no.
MFT-SU41SE	41140004
(Order data see chapter 1)	

# Multifunction time delay relay with external potentiometer

MFT SU41SE

Technical data	
<b>Nominal consumption</b>	
24 VAC/DC	0.8 VA / 0.6 W
110 VAC	2.4 VA / 0.6 W
240 VAC	19 VA / 1.1 W
<b>Control contact / Voltage controlled</b>	
Parallel switching of loads possible	
Parallel minimum load	1 VA or 0.5 W
Voltage dependence:	The potential between connections 2 and 5, resp. 7 and 5, must cover 90% of the supply voltage
Connecting length between connections 10 and 5:	10 m or capacity <10 nF
Resistance	>1 MΩ (contact K2 open)
Rest current at parallel load:	approx. 2 mA at contact K2 open
External Potentiometer 1 MΩ	Voltage on contact 6 and 8 24 VAC/DC resp. 110 ... 240 VAC Line length max. 5m (twisted pair)
Control pulse length	DC min. 50 ms AC min.100 ms
<b>Accuracy</b>	
Base accuracy	±5% of scale limit
Repeatability	
of the scale limit at constant conditions	±5% or ±100 ms
Adjustment accuracy	<5% of scale limit
Temperature influence	≤0.05% / °C
<b>Reaction times</b>	
Operating return time K1	max. 60 ms / 30 ms
Reaction time K2	max. 30 ms
Min. pulse/pause time K2	AC 50 ms / DC 50 ms
Recovery time	max. 100 ms

## Type key

MFT S U 2 2 S -	
<b>Construction</b>	<b>Special functions</b>
<b>S</b> Pluggable 11 poles	<b>E</b> External Potentiometer
<b>Functions</b>	<b>Control</b>
<b>U</b> Universal	<b>S</b> Voltage control
<b>A</b> Without auxiliary voltage	<b>P</b> Potential free
<b>T</b> Cycling timer	
<b>S</b> Star-delta	
<b>D</b> Digital	
<b>Output</b>	<b>Connecting range</b>
<b>1</b> 1 changer	<b>1</b> 24 VDC/AC and 110 ... 240 VAC
<b>2</b> 2 changers	<b>2</b> 12 ... 240 VAC/DC
<b>3</b> 1 changer / 1 immediate contact	<b>3</b> 24 ... 240 VAC/DC
<b>4</b> 1 changer / 1 closing contact	
<b>5</b> 1 closing / 1 opening contact	

# Multifunctional time delay relay with external potentiometer

MFT SU41SE

## Function descriptions

### E - Delay on

When the supply voltage U (K1 closed) is applied, the set interval t begins (green LED U/t flashes). After the interval t



has expired (green LED U/t illuminated) the output relay switches into on-position (yellow LED illuminated). This status remains until the supply voltage U (K1 opened) is interrupted. If the supply voltage U is interrupted before expiry of the interval t, the interval already expired is erased and is restarted when the supply voltage U (K1 closed) is next applied.

### A - Delay off

The supply voltage U (K1 closed or permanently connected) must be constantly applied to the device (green LED U/t illuminated).

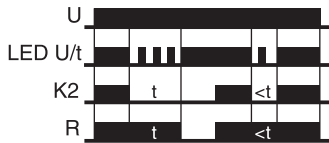

When the control contact K2 is closed, the output relay R switches into on-position (yellow LED illuminated). If the control contact K2 is opened, the set interval t begins (green LED U/t flashes). After the interval t has expired (green LED U/t illuminated) the output relay switches into off-position (yellow LED not illuminated).

If the control contact K2 is closed again before the interval t (green LED U/t illuminated) has expired, the interval already expired is erased and is restarted with the next cycle.

### B2 - Cycling timer starting on a pause

When the supply voltage U is applied, the set interval t begins (green LED U/t flashes). After the interval t has expired, the output relay R switches into on-position

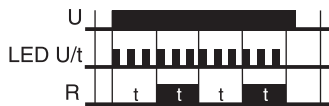

(yellow LED illuminated) and the set interval t begins again. After the interval t has expired, the output relay switches into off-position (yellow LED not illuminated). The output relay is triggered in the ratio 1:1 until the supply voltage is interrupted.

### I1 - Pulse limitation timer voltage control

When supply voltage U (K1 closed) is applied, the output relay R switches into on-position (yellow LED illuminated) and the set interval t begins (green LED

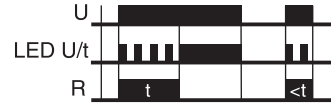

U/t flashes). After the interval t has expired (green LED U/t illuminated) the output relay switches into off-position (yellow LED not illuminated). This status remains until the supply voltage (K1 opened) is interrupted. If the supply voltage is interrupted before the interval t has expired, the output relay switches into off-position. The interval t already expired is erased and is restarted when the supply voltage is next applied.

### I2 - Pulse extension with control contact

The supply voltage U (K1 closed or permanently connected) must be constantly applied to the device (green LED U/t illuminated). When the control contact K2 is closed, the

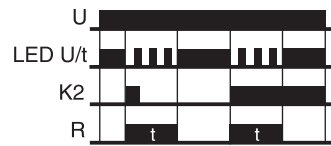

output relay R switches into on-position (yellow LED illuminated) and the set interval t begins (green LED U/t flashes). After the interval t has expired (green LED U/t illuminated) the output relay switches into off-position (yellow LED not illuminated).

During the interval, the control contact K2 can be operated any number of times. A further cycle can only be started when the cycle run has been completed.

### W2 - Wiping on trailing edge

The supply voltage U (K1 closed or permanently connected) must be constantly applied to the device (green LED U/t illuminated).

Closing the control contact K2 has no influence on the



condition of the output relay R. When the control contact K2 is opened, the output relay switches into on-position (yellow LED illuminated) and the set interval t begins (green LED U/t flashes). After the interval t has expired (green LED U/t illuminated), the output relay switches into off-position

# Multifunctional time delay relay with external potentiometer

## MFT SU41SE

### Function descriptions

(yellow LED not illuminated). During the interval, the control contact K2 can be operated any number of times. A further cycle can only be started when a cycle run has been completed.

#### E1 - Delay on with control contact

The supply voltage U (K1 closed or permanently connected) must be constantly applied to the device (green LED U/t illuminated).

When the control contact K2 is closed, the set interval t

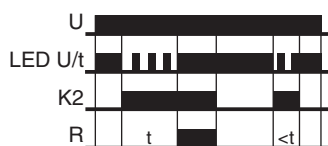

begins (green U/tLED flashes). After the interval t has expired (green LED U/t illuminated) the output relay R switches into on-position (yellow LED illuminated). This status remains until the control contact K2 is opened. If the control contact K2 is opened before the interval t has expired, the interval already expired is erased and is restarted with the next cycle.

### Connection

#### MFT SU41SE

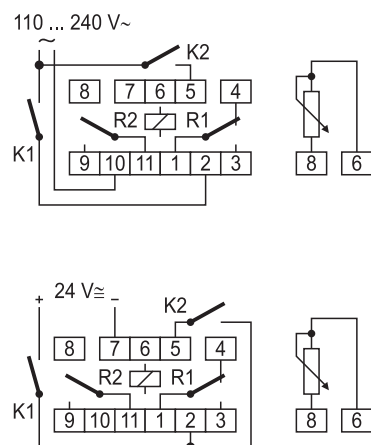

# Multifunction time delay relay with external potentiometer

MFT SU41SE

## Load limit curves

MFT SU41SE

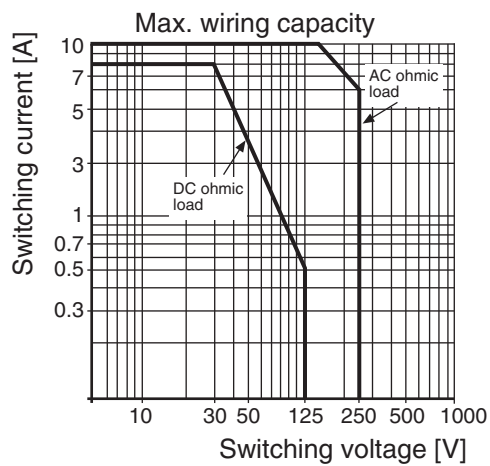

## Dimensions

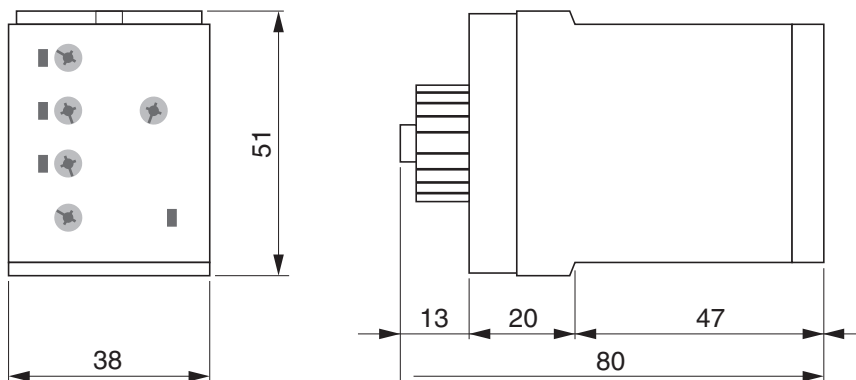





# Multifunction clock-pulse generator relay

## MFT ST22S

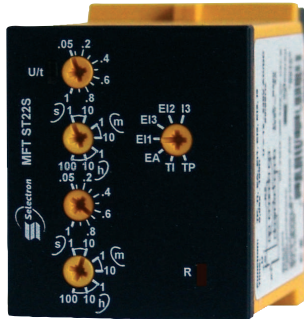

MFT ST22S

- **7 Function, 7 timer ranges**
- **Multivoltage:**  
**12 ... 240 VAC/DC**
- **2 Output contacts**

### Functions

- TP** Cycling timer relay beginning on a pause
- TI** Cycling timer relay beginning on a pulse
- EA** Delay on and delay off
- EI1** Input delay pulse limitation timer voltage control
- EI3** Input delay pulse limitation with control contact
- EI2** Wiping on leading and trailing edge with control contact
- I3** Pulse detection

### Time end ranges

Adjustable 0,05 s ... 100 h

### Output relay

2 potential free change over contact

250 VAC 8 A

### Indicators

- Green LED ON: indication of supply voltage
- Green LED flashes slowly: indication of time t1
- Green LED flashes fast: indication of time t2
- Yellow LED ON/OFF: indication of relay output

### Connecting voltage

12 ... 240 VAC/DC -10% +10%

48 ... 63 Hz, 100% duration of operation, IEC class 1c

### Reference data

Selectron® MFT	Article no.
MFT ST22S	41140006
(Order data see chapter 1)	

# Multifunctional clock-pulse generator relay

MFT ST22S

Technical data	
<b>Nominal consumption</b>	
12 ... 240 VAC/DC	6 VA / 2 W
<b>Control contact / Voltage controlled</b>	
Parallel switching of loads possible	
Parallel minimum load	1 VA or 0.5 W
Voltage dependence:	The potential between connections 2 and 5 must cover 90% of the supply voltage.
Connecting length between connections 2 and 5:	10 m or capacity <10 nF
Resistance	>1 MΩ (contact K2 open)
Rest current at parallel load:	approx. 2 mA at contact K2 open
<b>Accuracy</b>	
Base accuracy	±1% of scale limits
Repetition accuracy	±5ms or <0.5%
Adjustment accuracy	<5% of scale limits
Temperature influence	≤0.01% / °C
Voltage influence	-
<b>Reaction times</b>	
Operating/return time K1	max. 60 ms / 30 ms
Reaction time K2	max. 30 ms
Min. pulse/pause time K2	AC 100 ms / DC 50 ms
Recovery time	max. 100 ms

## Type key

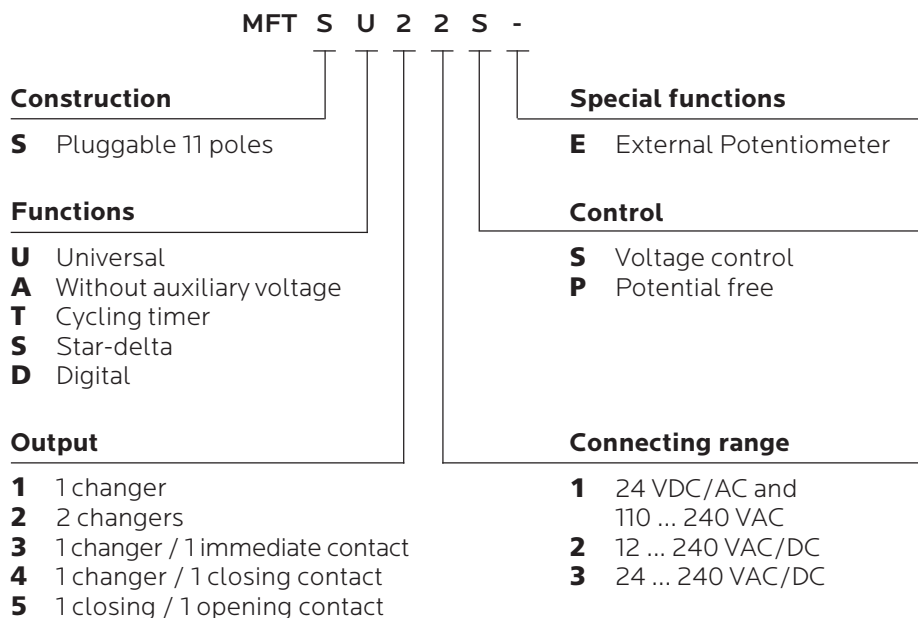

# Multifunctional clock-pulse generator relay

## MFT ST22S

### Function descriptions

#### TP - Cycling timer relay beginning on a pause

When the supply voltage U (K1 closed) is applied, the set interval t1 begins (green LED U/t flashes slowly). After the

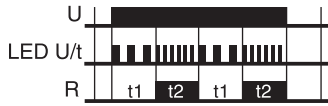

interval t1 has expired, the output relay R switches into on-position (yellow LED illuminated) and the set interval t2 begins (green LED U/t flashes fast). After the interval t2 has expired, the output relay switches into off-position (yellow LED not illuminated).

The output relay is triggered in the ratio of the two set intervals until the supply voltage U (K1 opened) is interrupted.

#### TI - Cycling timer relay beginning on a pulse

When the supply voltage U (K1 closed) is applied, the output relay R switches into on-position (yellow LED illuminated)

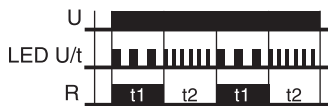

and the set interval t1 begins (green LED U/t flashes slowly). After the interval t1 has expired, the output relay switches into off-position (yellow LED not illuminated) and the set interval t2 begins (green LED U/t flashes fast). After the interval t2 has expired, the output relay switches into on-position again (yellow LED illuminated).

The output relay is triggered in the ratio of the two set intervals until the supply U (K1 opened) voltage is interrupted.

#### EA -Delay on and delay off

The supply voltage U (K1 closed or permanently connected) must be constantly applied to the device (green LED U/t

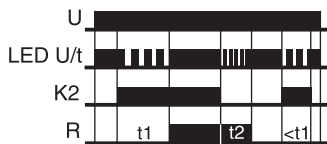

illuminated). When the control contact K2 is closed, the set interval t1 begins (green LED U/t flashes slowly). After the interval t1 has expired, the output relay R switches into on-position (yellow LED illuminated). When the control contact K2 is opened, the set interval t2 begins (green LED U/t flashes fast). After the interval t2 has expired, the output relay switches into off-position (yellow LED not illuminated).

If the control contact K2 is opened before the interval t1 has expired, the interval already expired is erased and is restarted with the next cycle.

#### E11 - Input delay pulse limitation timer voltage control

When the supply voltage U (K1 closed) is applied, the set interval t1 begins (green LED U/t flashes slowly). After the

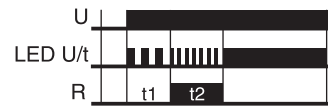

interval t1 has expired, the output relay R switches into on-position (yellow LED illuminated) and the set interval t2 begins (green LED U/t flashes fast). After the interval t2 has expired, the output relay switches into off-position (yellow LED not illuminated). If the supply voltage is interrupted before the interval t1+t2 has expired, the interval already expired is erased and is restarted when the supply voltage is next applied.

#### E13 - Input delay pulse limitation timer with control contact

The supply voltage U (K1 closed) must be constantly applied to the device (green LED U/t illuminated). When the control

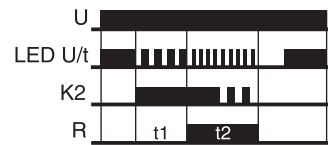

contact K2 is closed, the set interval t1 begins (green LED U/t flashes slowly). After the interval t1 has expired, the output relay switches into on-position (yellow LED illuminated) and the set interval t2 begins (green LED U/t flashes fast). After the interval t2 has expired, the output relay switches into off-position (yellow LED not illuminated). During the interval, the control contact K2 can be operated any number of times. A further cycle can only be started when the cycle run has been completed.

#### E12 - Wiping on leading and trailing edge with control contact

The supply voltage U must be constantly applied to the device (green LED U/t illuminated). When the control

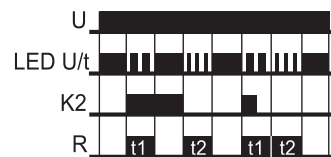

contact K2 is closed, the output relay R switches into on-position (yellow LED illuminated) and the set interval t1 begins (green LED U/t flashes slowly). After the interval t1

# Multifunctional clock-pulse generator relay

## MFT ST22S

### Function descriptions

has expired, the output relay R switches into off-position (yellow LED not illuminated).

If the control contact is opened, the output relay again switches into on-position (yellow LED illuminated) and the set interval t2 begins (green LED U/t flashes fast). After the interval t2 has expired the output relay switches into off-position (yellow LED not illuminated). During the interval, the control contact can be operated any number of times.

### I3 - Pulse detection

When the supply voltage U (K1 closed) is applied, the set interval t1 begins (green LED U/t flashes slowly) and the

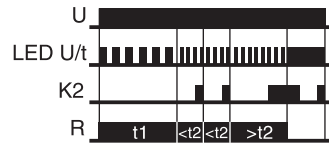

output relay R switches into on-position (yellow LED illuminated). After the interval t1 has expired, the set interval t2 begins (green LED U/t flashes fast). For the output relay to remain in on-position, the control contact K2 must be closed and reopened within the set interval t2. If this does not occur, the output relay R switches into off-position (yellow LED not illuminated) and all further pulses at the control contact K2 are ignored. To restart the function, the supply voltage must be interrupted and reapplied.

### Connection

#### MFT ST22S

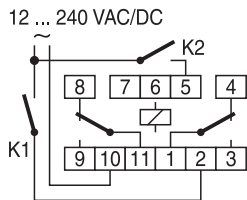

### Load limit curve

#### MFT ST22S

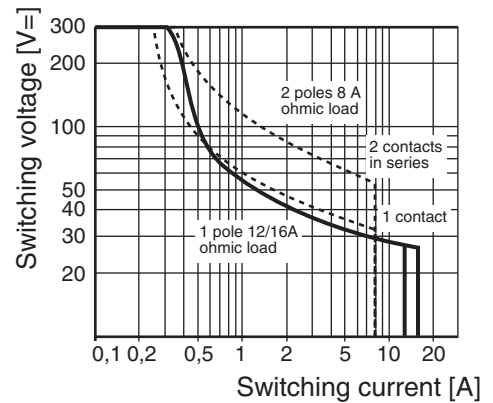

### Dimensions

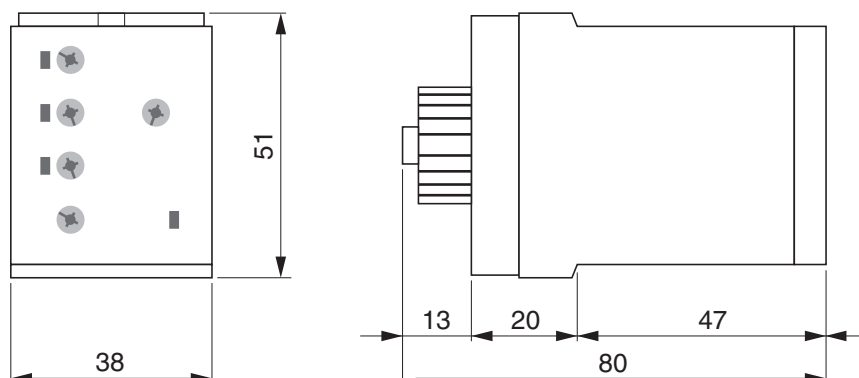

# Multifunctional clock-pulse generator relay with external potentiometer

## MFT ST51SE

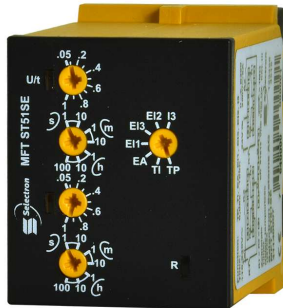

MFT ST51SE

- **7 Function, 7 timer ranges**
- **Multivoltage:**  
**24 VAC/DC and 110 ... 240 VAC**
- **2 Output contacts**

### Functions

- TP** Cycling timer relay beginning on a pause
- TI** Cycling timer relay beginning on a pulse
- EA** Delay on and delay off
- EI1** Input delay pulse limitation timer voltage control
- EI3** Input delay pulse limitation with control contact
- EI2** Wiping on leading and trailing edge with control contact
- I3** Pulse detection

### Time end ranges

Adjustable 0,05 s ... 100 h

### Output relay

1 closing contact and 1 opening contact potential free  
250 VAC 5 A units close together 8 A units not close together

### Indicators

- Green LED ON: indication of supply voltage
- Green LED flashes slowly: indication of time t1
- Green LED flashes fast: indication of time t2
- Yellow LED ON/OFF: indication of relay output

### Connecting voltage

- 24 VDC  $\pm 10\%$
- 24 VAC -15% ... +10%
- 110 ... 240 VAC -15% ... +10%

### Reference data

Selectron® MFT	Article no.
MFT ST51SE	41140007
(Order data see chapter 1)	

# Multifunctional clock-pulse generator relay with external potentiometer

MFT ST51SE

Technical data	
<b>Nominal consumption</b>	
24 VAC/DC	0.8 VA / 0.6 W
110 VAC	2.4 VA / 0.6 W
230 VAC	19 VA / 1.1 W
<b>Control contact / Voltage controlled</b>	
Parallel switching of loads possible	
Parallel minimum load	1 VA or 0.5 W
Voltage dependence:	The potential between connections 2 and 5, resp. 7 and 5, must cover 90% of the supply voltage.
Connecting length between connections 10 and 5:	10 m or capacity <10 nF
Resistance	>1 M $\Omega$ (contact K2 open)
Rest current at parallel load:	approx. 2 mA at contact K2 open
External Potentiometer 1 M $\Omega$	Voltage on contact 3 and 6 resp. 6 and 8 24 VAC/DC resp. 110 ... 240 VAC Line length max. 5m (twisted pair)
<b>Accuracy</b>	
Base accuracy	$\pm 1\%$ of scale limit $\pm 5\%$ if external Ppoteniometer is connected
Repeatability of the scale limit at constant conditions	$\pm 5\%$ or $\pm 100\text{ms}$
Adjustment accuracy	<5%
Temperature influence	$\leq 0.05\% / ^\circ\text{C}$
<b>Reaction times</b>	
Operating/return time K1	max. 60 ms / 30 ms
Reaction time K2	max. 30 ms
Min. pulse/pause time K2	AC 50 ms / dc 50 ms
Recovery time	max. 200 ms

## Type key

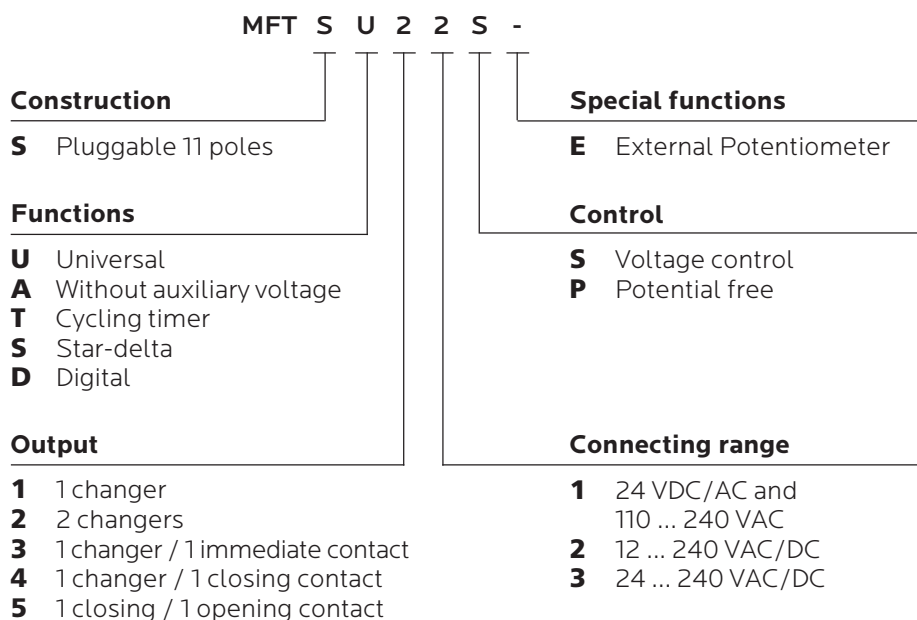

# Multifunctional clock-pulse generator relay with external potentiometer

MFT ST51SE

## Function descriptions

### TP - Cycling timer relay beginning on a pause

When the supply voltage U (K1 closed) is applied, the set interval t1 begins (green LED U/t flashes slowly).

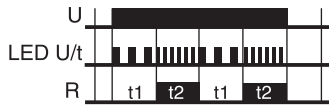

After the interval t1 has expired, the output relay switches into on-position (yellow LED illuminated) and the set interval t2 begins (green LED U/t flashes fast). After the interval t2 has expired, the output relay switches into off-position (yellow LED not illuminated).

The output relay is triggered in the ratio of the two set intervals until the supply voltage U (K1 opened) is interrupted.

### TI - Cycling timer relay beginning on a pulse

When the supply voltage U (K1 closed) is applied, the output relay R switches into on-position (yellow LED

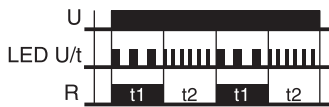

illuminated) and the set interval t1 begins (green LED U/t flashes slowly). After the interval t1 has expired, the output relay switches into off-position (yellow LED not illuminated) and the set interval t2 begins (green LED U/t flashes fast). After the interval t2 has expired, the output relay switches into on-position again (yellow LED illuminated).

The output relay is triggered in the ratio of the two set intervals until the supply U (K1 opened) voltage is interrupted.

### EA - Delay on and delay off

The supply voltage U (K1 closed or permanently connected) must be constantly applied to the device

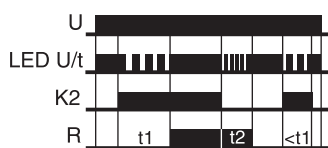

(green LED U/t illuminated). When the control contact K2 is closed, the set interval t1 begins (green LED U/t flashes slowly). After the interval t1 has expired, the output relay R switches into on-position (yellow LED

illuminated). When the control contact K2 is opened, the set interval t2 begins (green LED U/t flashes fast). After the interval t2 has expired, the output relay switches into off-position (yellow LED not illuminated). If the control contact K2 is opened before the interval t1 has expired, the interval already expired is erased and is restarted with the next cycle.

### EI1 - Input delay pulse limitation timer voltage control

When the supply voltage U (K1 closed) is applied, the set interval t1 begins (green LED U/t flashes slowly). After the

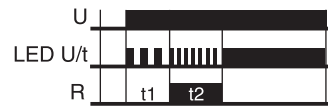

interval t1 has expired, the output relay switches into on-position (yellow LED illuminated) and the set interval t2 begins (green LED U/t flashes fast). After the interval t2 has expired, the output relay switches into off-position (yellow LED not illuminated). If the supply voltage is interrupted before the interval t1+t2 has expired, the interval already expired is erased and is restarted when the supply voltage is next applied.

### EI3 - Input delay pulse limitation timer with control contact

The supply voltage U (K1 closed) must be constantly applied to the device (green LED U/t illuminated). When the control

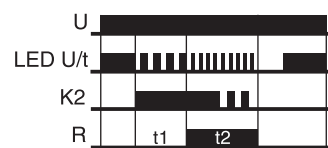

contact K2 is closed, the set interval t1 begins (green LED U/t flashes slowly). After the interval t1 has expired, the output relay switches into on-position (yellow LED illuminated) and the set interval t2 begins (green LED U/t flashes fast). After the interval t2 has expired, the output relay switches into off-position (yellow LED not illuminated). During the interval, the control contact K2 can be operated any number of times. A further cycle can only be started when the cycle run has been completed.



# Multifunctional clock-pulse generator relay with external potentiometer

MFT ST51SE

## Function descriptions

### E12 - Wiping on leading and trailing edge with control contact

The supply voltage  $U$  must be constantly applied to the device (green LED  $U/t$  illuminated). When the control

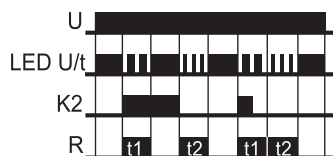

contact  $K2$  is closed, the output relay  $R$  switches into on-position (yellow LED illuminated) and the set interval  $t1$  begins (green LED  $U/t$  flashes slowly). After the interval  $t1$  has expired, the output relay  $R$  switches into off-position (yellow LED not illuminated).

If the control contact is opened, the output relay again switches into on-position (yellow LED illuminated) and the set interval  $t2$  begins (green LED  $U/t$  flashes fast). After the interval  $t2$  has expired the output relay switches into off-position (yellow LED not illuminated). During the interval, the control contact can be operated any number

of times. off-position (yellow LED not illuminated). During the interval, the control contact can be operated any number of times.

### I3 - Pulse detection

When the supply voltage  $U$  ( $K1$  closed) is applied, the set interval  $t1$  begins (green LED  $U/t$  flashes slowly) and the output relay  $R$  switches into on-position (yellow LED illuminated). After

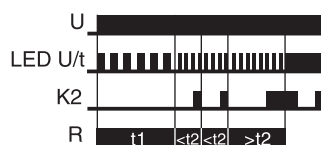

the interval  $t1$  has expired, the set interval  $t2$  begins (green LED  $U/t$  flashes fast). For the output relay to remain in on-position, the control contact  $K2$  must be closed and reopened within the set interval  $t2$ . If this does not occur, the output relay  $R$  switches into off-position (yellow LED not illuminated) and all further pulses at the control contact  $K2$  are ignored. To restart the function, the supply voltage must be interrupted and reapplied.

## Connection

### MFT ST51SE

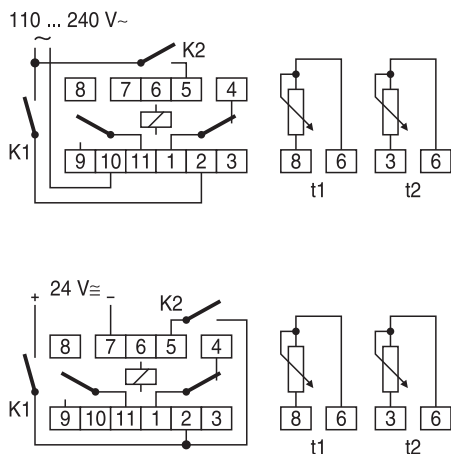

## Load limit curve

### MFT ST51SE

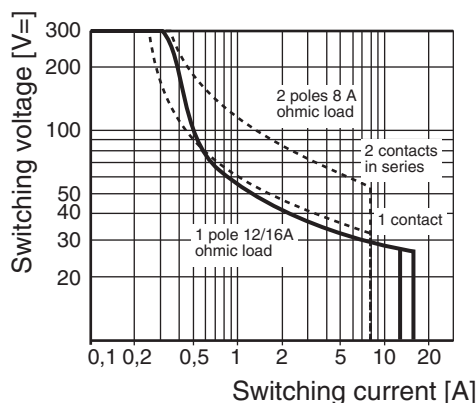

## Dimensions

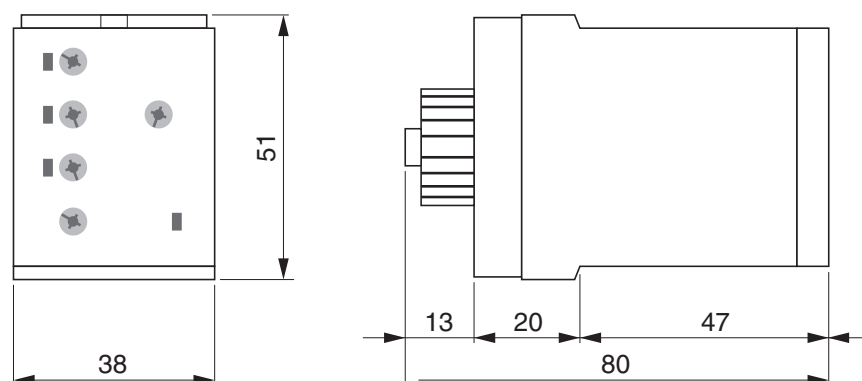

## Delay off without supply voltage

### MFT SA23S

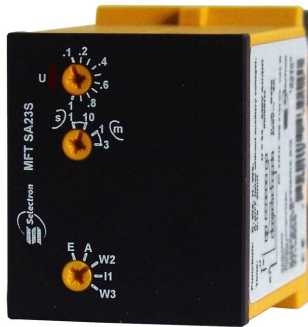

MFT SA23S

- 5 Function, 4 time ranges
- Multivoltage:  
24 ... 240 VAC/DC
- 2 Output contacts

#### Functions

- E** On delay
- A** Off delay without auxiliary voltage
- W2** Wiping on trailing edge voltage control (non-resetting on voltage failure)
- I1** Pulse limitation timer voltage control (non-resetting on voltage failure)
- W3** Wiping on leading and trailing edge voltage control (non-resetting on voltage failure)

#### Time end ranges

Adjustable 0,1 s ... 3 min.

#### Output relay

2 changers potential free  
250 VAC / 8 A

#### Indicators

Green LED ON: indication of supply voltage

#### Connecting voltage

24 ... 240 VAC/DC, ac: -15% +10%, dc: -10% +10%  
48 ... 63 Hz, 100% duration of operation, IEC class 1c

#### Reference data

Selectron® MFT	Article no.
MFT SA23S	41140008
(Order data see chapter 1)	



#### Note:

After transport the output relay maybe in any position.  
The correct operation will be given after the first cycle.

# Delay off without supply voltage

MFT SA23S

Technical data		
<b>Nominal consumption</b>		
	AC	1 VA / 0.5 W
	DC	0.7 VA / 0.7 W
<b>Accuracy</b>		
	Base accuracy	± 1% of scale limit ≤ 10% for time range 1s
	Repetition accuracy	1% or 100 ms
	Adjustment accuracy	< 5% of scale limit
	Temperature influence	≤ 0,02% / °C
<b>Reaction time</b>		
	Recovery time	100 ms

## Type key

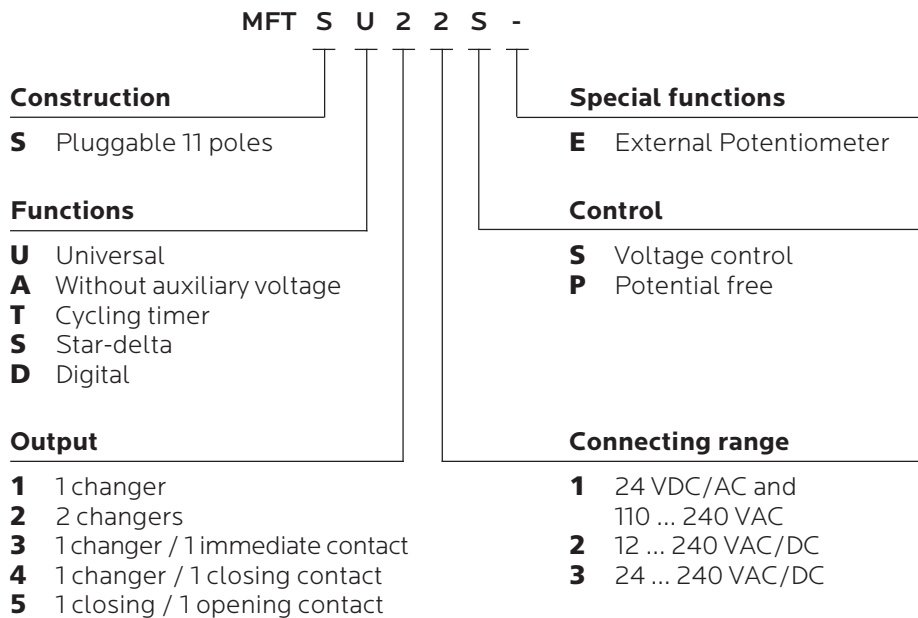

# Delay off without supply voltage

## MFT SA23S

### Function descriptions

#### E - On delay

Activation by  $U_s$  via K1. When K1 closes, the set interval  $t$  begins (green LED U illuminated).



After the interval  $t$  has elapsed, the output relay picks up and remains in the working position until K1 is opened again. Interrupting  $U_s$  during the interval  $t$  causes a reset.

#### A - Off delay

Activation by  $U_s$  via K1. The output relay picks up after K1 closes. If K1 is opened again, the set interval  $t$  begins (green LED U not illuminated).



After the interval  $t$  has elapsed, the output relay drops back out to its rest position. Operating K1 during the interval  $t$  causes a time reset.

#### I1 - Pulse limitation timer voltage control

Activation by  $U_s$  via K1. When K1 closes, the output relay picks up immediately and the set interval  $t$  begins (green LED U illuminated).



After the interval  $t$  has elapsed, the output relay drops back out to its rest position. This condition is maintained until  $U_s$  is interrupted. Interrupting  $U_s$  before the interval  $t$  has elapsed means that the output relay remains picked up until the interval  $t$  has fully elapsed.

#### W2 - Wiping on trailing edge voltage control

Activation by  $U_s$  via K1. The output relay remains dropped out after K1 closes. As soon as K1 is opened, the output relay picks up and the set interval  $t$  begins (green LED U not illuminated).



After the interval  $t$  has elapsed, the output relay drops out. Closing K1 before the interval  $t$  has elapsed means that the

output relay remains picked up until the interval  $t$  has fully elapsed.

#### W3 - Wiping on leading and trailing edge voltage control

Activation by  $U_s$  via K1. When K1 closes, the output relay picks up and the set interval  $t$  begins (green LED U illuminated).



After the interval  $t$  has elapsed, the output relay drops out. As soon as K1 is opened, the output relay picks up and the set interval  $t$  begins (green LED U not illuminated).

After the interval  $t$  has elapsed, the output relay drops out. Interrupting or re-applying  $U_s$  before the interval  $t$  has elapsed means that the output relay remains picked up until the interval  $t$  has fully elapsed.

# Delay off without supply voltage

MFT SA23S

## Connection

MFT SA23S

24 ... 240 VAC/DC

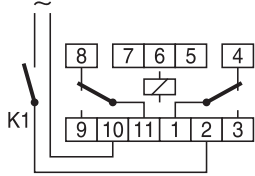

## Load limit curve

MFT SA23S

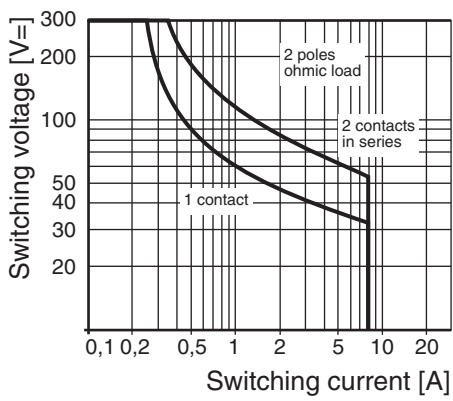

## Dimensions

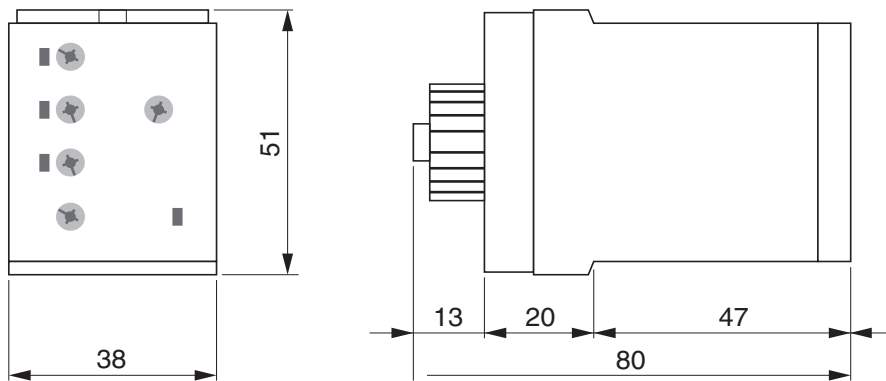

## Star-delta relay

### MFT SS22S

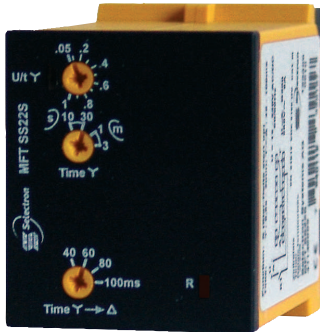

MFT SS22S

- 1 Function, 4 time ranges
- Multivoltage:  
12 ... 240 VAC/DC
- 2 Output controls

#### Functions

S Star-delta

#### Time end ranges

Star times 500 ms - 10 s, 1,5 s - 30 s, 3 s - 1 min., 9 s - 3 min.  
Change over time 40 ms, 60 ms, 80 ms, 100 ms

#### Output relay

2 potential free change over contacts  
250 VAC 8 A

#### Indicators

Green LED ON: indication of supply voltage  
Green LED flashes: indication of time period - start-up time  
Yellow LED ON/OFF: indication of star-contactor

#### Connecting voltage

12 ... 240 VAC/DC -10% +10%  
48 ... 63 Hz, 100% duration of operation, IEC class 1c

#### Reference data

Selectron® MFT	Article no.
MFT SS22S	41140009
(Order data see chapter 1)	

# Star-delta relay

MFT SS22S

Technical data	
<b>Nominal consumption</b>	
12 ... 240 VAC/DC	6 VA / 2 W
Residual ripple to dc	10%
Dop-out voltage	> 30% of the supply voltage
<b>Accuracy</b>	
Repetition accuracy	±5 ms or <0.5%
Adjustment accuracy	<5%
Temperature influence	≤0.01% / °C
Base accuracy	±1% of scale limit
Voltage influence	-
<b>Reaction time</b>	
Recovery time	100 ms

## Type key

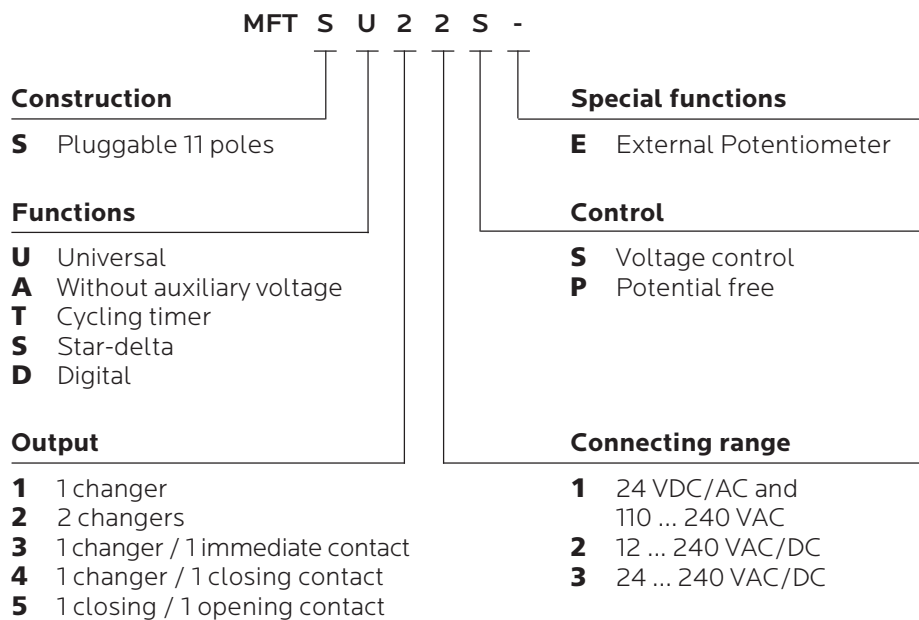

# Star-delta relay

MFT SS22S

## Function descriptions

### S - Star-delta start-up

When the supply voltage  $U$  is applied, the star-contact switches into on-position (yellow LED illuminated) and the set star-time  $Y$  begins (green LED  $U/t$  flashes).

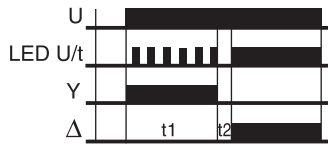

After the interval  $Y$  has expired (green LED  $U/t$  illuminated) the star-contact switches into off-position (yellow LED not illuminated) and the set transit-time ( $Y \rightarrow \Delta$ ) begins. After the interval  $\Delta$  has expired the contact for the delta-contactor switches into on-position (green LED  $U/t$  illuminated). To restart the function the supply voltage must be interrupted and re-applied.

## Connection

### SS22S

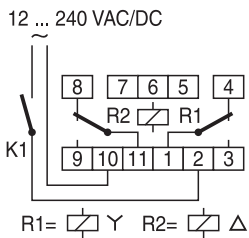

## Load limit curve

### MFT SS22S

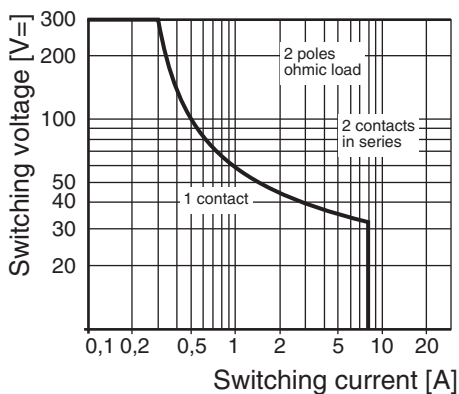



# Star-delta relay

MFT SS22S

## Dimensions

---

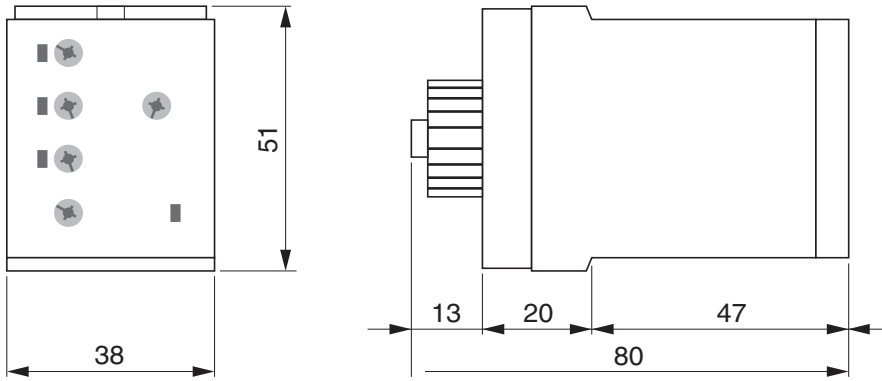

## Plug in socket

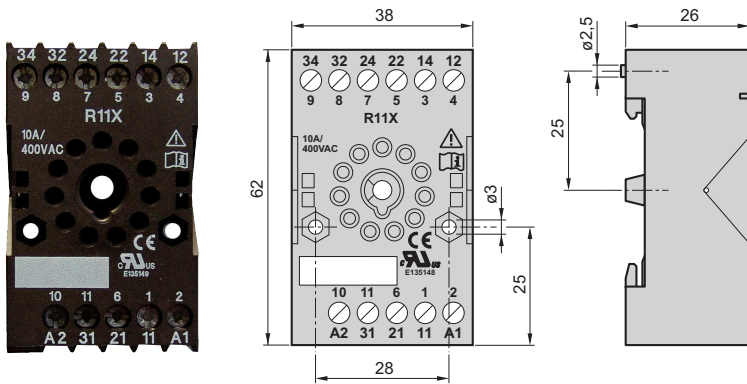

Plug in socket 11 poles	Article no.
SSK 11 N	41910006
(Order data see chapter 1)	

## External potentiometer

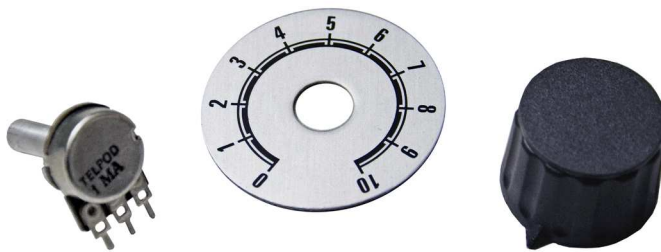

Potentiometer POTSET	
Resistor	1 M $\Omega$
Article no.	41920033
(Order data see chapter 1)	

Potentiometer, turning knob and scale are included in the delivery

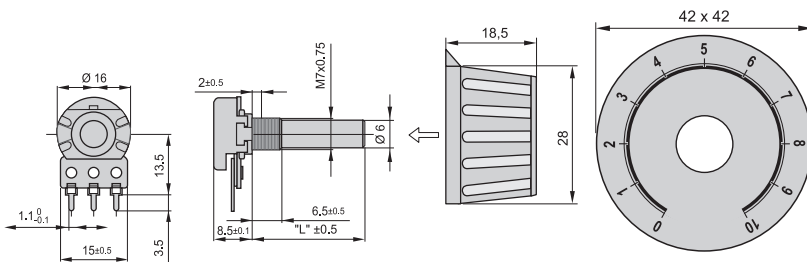

Potentiometer EXPOT 1	
Resistor	1 M $\Omega$
Angle of rotation	295 °
Front protection	IP 64
Mounting diameter	22,5 mm
Connection	Screw terminals
Article no.	41920034
(Order data see chapter 1)	

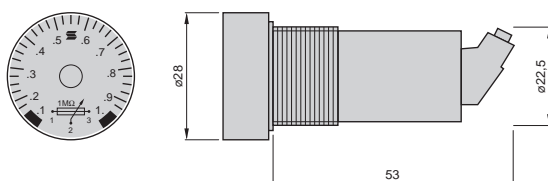

## Technical safety advice

This manual contains the information necessary for the correct utilisation of the products described therein. It is intended for technically qualified persons who are involved as either

- planning engineers familiar with the safety concepts of automation technology;
- or, operating personnel, who have been instructed in handling automation equipment and have a knowledge of the contents of this manual concerning operation;
- or, installation and servicing personnel possessing the necessary training to repair such an automation system or who have the authority to put such circuits and equipment/systems into operation, to earth or label them according to the relevant safety standards.

The products are constructed, manufactured and tested in compliance with the relevant VDE standards, VDE specifications and IEC recommendations.

### Danger warning

These warnings serve both as a guide for those persons involved in a project and as safety advice to prevent damage to the products themselves or to associated equipment.

Due to advancements in technology, the wiring diagram on the actual device may be different than shown in this catalogue. In all instances where the actual device diagram is different, the wiring diagram on the device must be used when electrical connections are made.

### Correct utilisation, configuration and assembly

The equipment is to be used only for the applications stated in the catalogue and technical literature, and only in conjunction with auxiliary equipment and devices that are recommended or approved by Selectron Systems Ltd.

Further, it should be noted that:

- the automation equipment must be disconnected from any power supply before it is assembled, disassembled or the configuration modified.

- Solid state electronic switches must not be tested with incandescent lamps or connected to a load that exceeds its rating.
- trouble-free and safe operation of the products requires correct transportation as well as appropriate storage, assembly and wiring.
- the systems may only be installed by trained personnel. In doing so, the relevant requirements contained in VDE 0100, VDE 0113, IEC 364, etc. must be complied with.

### Prevention of material damage or personal injury

Additional external safety devices or facilities must be provided wherever significant material damage or even personal injury could result from a fault occurring in an automation system. A defined operating status must be ensured or forced by such devices or facilities (e.g. by independent limit switches, mechanical interlocks, etc.).

### Advice concerning planning and installation of the products

- The safety and accident prevention measures applicable to a specific application are to be observed.
- In the case of mains-operated equipment, a check is to be made before putting it into operation to ensure that the preset mains voltage range is suitable for the local supply.
- In the case of a 24 V supply, care must be taken to ensure sufficient electrical insulation of the secondary side. Use only mains power supply units that conform to IEC 364-4-41 or HD 384.04.41 (VDE 0100 Part 410).
- Automation systems and their operating elements are to be installed in such a way that they are sufficiently protected against accidental operation.

### Warranty

Selectron Systems Ltd. warrants its products to be free from defects in material and workmanship for a period of one year from the date of shipment. All claims under this warranty must be made within thirty (30) days of the discovery of the defect, and all defective products must be returned at the buyer's expense. Buyer's sole and exclusive right will be limited to, at the option of Selectron Systems Ltd., the repair or replacement by Selectron Systems Ltd., of any defective products for which a claim is made.

In all other matters please refer to the "General terms of business" concerning Selectron Systems Ltd.

### Note

The information given in this documentation corresponds to the state of development at the time of going to press and is therefore not binding. Selectron Systems Ltd. reserves the right to make alterations in the interests of technical advancement or product improvement at any time without giving reasons for doing so.

## Prescriptions and standards

<b>Mechanical data</b>	
Housings in self-extinguishing plastic material. Protection mode IP 40	
Mounting: snapping mode:	Fixing on profile rail TS 35 according EN 60715 Connection via contact protected terminals up to 4 mm <sup>2</sup> , protecting mode IP 20
Mounting: plugable mode:	Fixing and connection via 11 pole screw or soldering plug socket Pin arrangement and connection mark according IEC67-1-18a
<b>Environmental conditions</b>	
Admissible environmental temperatures from -25 °C ... +55 °C according to 60068-1	
Storage and transport temperature from -25 °C ... +70 °C	
Climatic conditions according to IEC 60721-3-3 class 3K3	
<b>Output relay</b>	
Electrical lifetime:	250 VAC, 2 x 10 <sup>5</sup> switching cycles at 1000 VA resistive load
Mechanical lifetime:	20 x 10 <sup>6</sup> switching cycles
Contact material	AgNi 0,15
<b>Supply voltage</b>	
Frequency range	48 ... 63 Hz
Duty cycle	100%, IEC class 1c
<b>Protection</b>	
Protection of the unit	8 A fast
<b>Terminals</b>	
Contact protection according VDE 0106 and VBG 4	
Terminal arrangement and connecting mark according DIN 46 199	
Terminal type:	sleeve with indirect screw pressure
Wire to connect:	rigid or flexible
Connecting limit:	4 mm <sup>2</sup>
Terminal variants:	1 wire 0,5 mm <sup>2</sup> ... 2,5 mm <sup>2</sup> with/without wire end covers 1 wire 4 mm <sup>2</sup> without wire end covers 2 wires 0,5 mm <sup>2</sup> ... 1,5 mm <sup>2</sup> with/without wire end covers 2 wires 2,5 mm <sup>2</sup> flexible without wire end covers
max. screw in torque: 1,0 Nm	
Terminal screw for screw driver or Pozi drive PZ-1	
<b>Insulation</b>	
Isolation nominal voltage:	250 VAC according to IEC 60664-1
Rating surge voltage:	4 kV, over-voltage category III, according to IEC 60664-1
<b>Electromagnetic compatibility</b>	
Electrostatic discharge: Level 3, 6 kV contact, 8 kV air, according to IEC 61000-4-2	
High frequency electromagnetic fields: Level 3, 10 V/m, according to IEC 61000-4-4	
Fast transients: Level 4, 4 kV / 2,5 kHz, 5/50 ns, according to IEC 61000-4-3	
Lightning discharge: Level 3, 2 kV com., 1 kV dif., according to IEC 61000-4-5	
Cable running disturbances inducted by HF fields: Level 3, 10 V RMS, according to IEC 61000-4-6)	
Spurious radiation net and aerial network: Class A, according to CISPR 22)	
<b>Prescriptions</b>	
Air and leakage paces:	IEC 61812-1
Test voltage:	IEC 61812-1 1640 VAC
Low voltage directions according to IEC 61812-1	
EMC emissions:	according to IEC 61812-1 class A
EMC interference stability:	Voltage impact strength according to IEC 61000-4-5
Burst:	according to IEC 61812-1 (level 3)
ESD:	according to IEC 61000-4-2
HF over metallic circuits:	according to IEC 61812-1
Electro magnetic HF field according to IEC 61812-1	
Production standard:	according to ISO 9001