

Hybrid stepper motors

6630-24

- Step angle..... 1.8°
- Diameter 86 mm
- Weight 1500 g
- Holding torque ... 2.75 Nm

The hybrid stepper motor comes into its own where torque at low speed, positioning, and accuracy are determining factors.

► Technical data

	Part N°	Phase resistance [Ω]	Phase inductance [mH]	Phase current [A]	Holding torque [Nm]	Nominal power [W]
Phases in parallel	6630-24-4-0.4	0.2	1.2	6.8	2.75	18.5
	6630-24-4-1.8	0.9	4.6	3.2	2.75	18.5
Phases in series	6630-24-4-0.4	0.8	4.8	3.4	2.75	18.5
	6630-24-4-1.8	3.6	18.4	1.6	2.75	18.5

Steps/rev.	200
Step accuracy	± 5%
Rotor inertia	1390 gcm²
Insulation class	B 130 °C
Protection	DIN 40050 IP 30
Test voltage	500 VAC
Detent torque	120 mNm

► Dimensions

Drawing not to scale. All dimensions in mm.

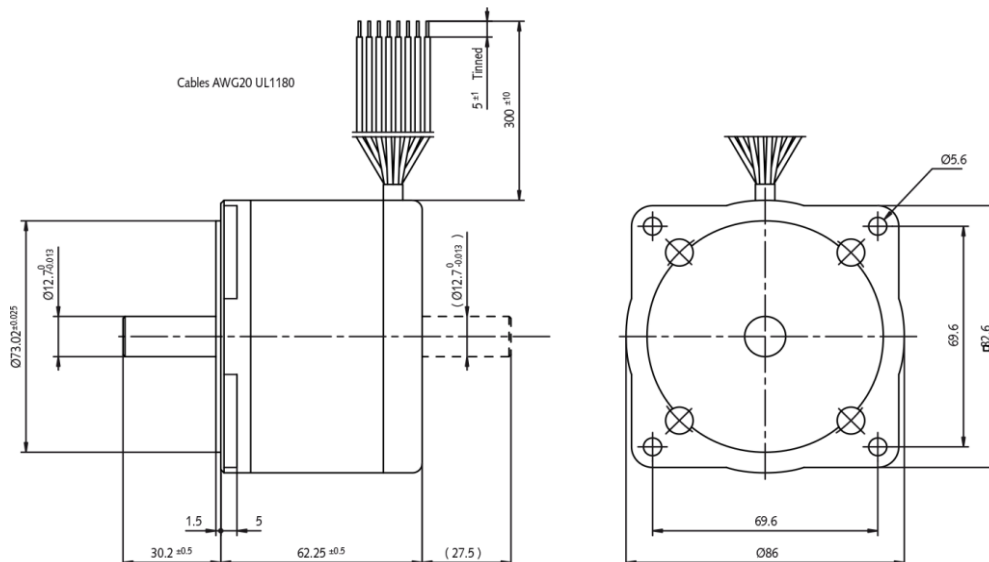

► Dynamic characteristics

• 6630-24-4-0.4 ► Phases in parallel

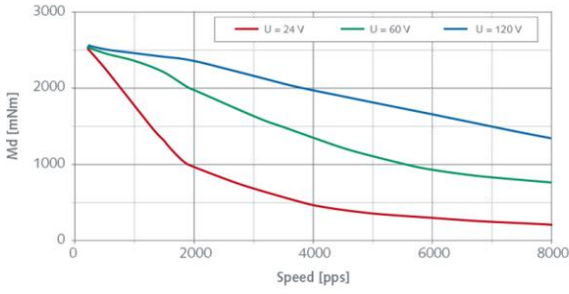

• 6630-24-4-1.8 ► Phases in parallel

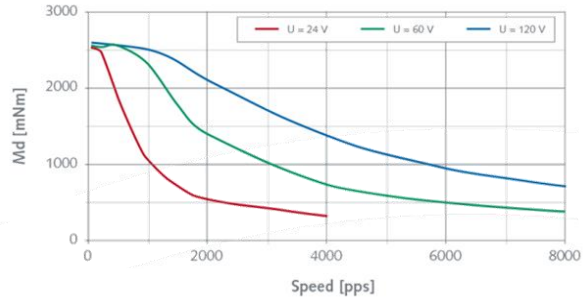

• 6630-24-4-0.4 ► Phases in series

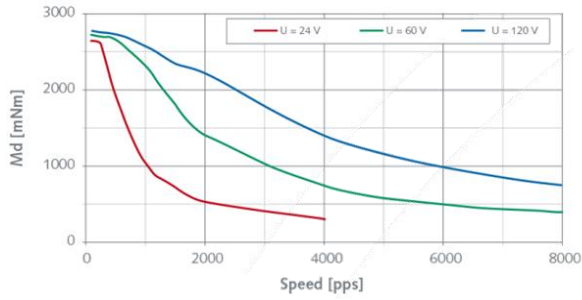

• 6630-24-4-1.8 ► Phases in series

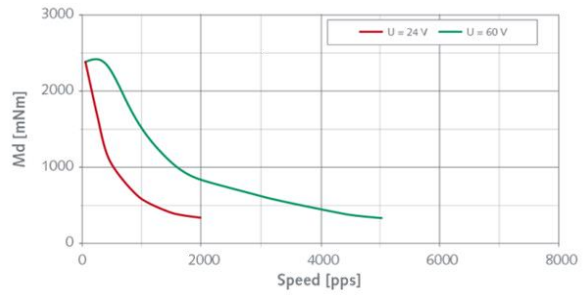

[pps] = pulses per second

► Static characteristics

• 6630-24-4 Series

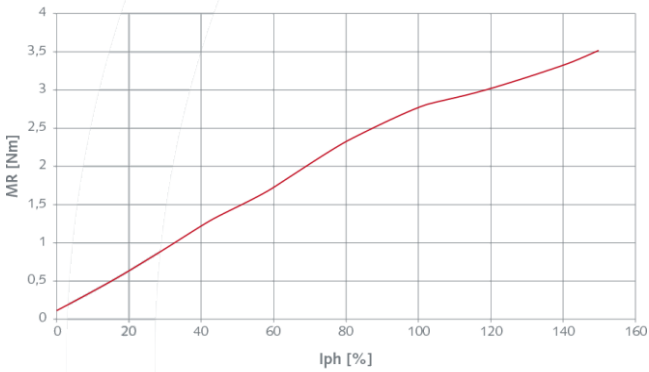

► Electrical Interface

► Phases in parallel

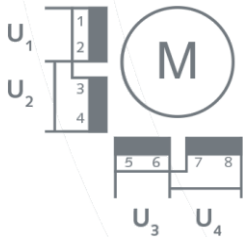

► Phases in series

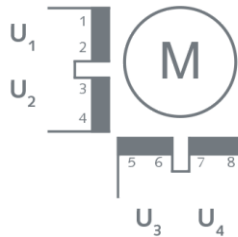

- U₁ 1 green
2 orange
- U₂ 3 black-white
4 green-white
- U₃ 5 red
6 black
- U₄ 7 white
8 red-white

Special requirements upon customer specifications. Right to change reserved.

<2.0>

SONCEBOZ SA

2605 Sonceboz – Switzerland

Tel. +41(0) 32 488 11 11

Fax +41(0) 32 488 11 00

info@sonceboz.com - www.sonceboz.com

