

## FEATURES

- High quality components with the following characteristics:
  - High admissible loads
  - Accurate guiding
  - High overall sturdiness
  - «H» guiding unit: Excellent mobility, low wear and long life with the linear ball bearings
  - The cylinder rod is fixed to the guiding unit by an alignment compensation bracket

## GENERAL (GUIDING UNIT)

<b>Min. stroke (with detectors)</b>	50 mm
<b>Maximum stroke</b>	500 mm (other strokes on request)
<b>Max. speed rate</b>	1 m/s



## CONSTRUCTION

"U" and "H" guiding units with slide bearings		"H" guiding unit with ball bearings	
Single block unit	Metal body	Single block unit	Metal body
4 self-lubricating roller bearings	Sintered bronze	4 linear ball bearings	
2 guiding rods	Chrome-plated steel	2 guiding rods	Hardened steel
Lip seals on the guiding rods		Lip seals on the guiding rods	
		2 type KP2K DIN 51825 grease nipples	

## MOUNTINGS

- Guiding unit on frame: 4 mounting options using 4 tapped holes (on the 2 smallest and largest sides)+ 2 holes for centring.
- Load on the guiding unit: 2 options, using 4 tapped holes or 4 spotfaced holes + 2 holes for centring.

## HOW TO ORDER

### UNIT CONSISTING OF SERIES 453 OR 450 CYLINDER + GUIDING UNIT

#### 15-DIGIT PRODUCT CODE

**G 45- A - S K - - - HCG**

**Thread connection**  
 G = ISO 228/1

**Product series**  
 453  
 450

**Revision letter**  
 A = Initial release

**Diameter (mm)**  
 3 = 32  
 4 = 40  
 5 = 50  
 6 = 63  
 8 = 80  
 1 = 100

**P** = 125 (450 series)  
**Q** = 160 (450 series)  
**R** = 200 (450 series)

#### Rod options 1

##### Series 453:

**S** = Standard  
**3** = AISI 303 stainless steel rod <sup>(1)</sup>

##### Series 450:

**S** = Standard (chromed single rod + rod nut)  
**3** = AISI 303 stainless steel rod + rod nut <sup>(1)</sup>  
**6** = AISI 316 stainless steel rod + rod nut

<sup>(1)</sup> 316L stainless steel rod, contact us.

#### Options

**UCG** = Plain bearing "U" Guiding Unit  
**HCG** = Plain bearing «H» Guiding Unit  
**HBG** = Ball bearing «H» Guiding Unit

#### Recommended standard strokes <sup>(1)</sup>

**0050** = 50 mm  
**0080** = 80 mm  
**0100** = 100 mm  
**0125** = 125 mm  
**0160** = 200 mm  
**0200** = 200 mm  
**0250** = 250 mm  
**0320** = 320 mm  
**0400** = 400 mm  
**0500** = 500 mm

<sup>(1)</sup> Other strokes on request.  
 Min. stroke: 25 mm  
 max. stroke: 2000 mm

#### Rod options 2

**Series 453 / Series 450**  
**K** = Standard

## POSITION DETECTORS

The magnetic position detectors are ordered separately: "T" model (see page P291), reed switch or magneto-resistive type

**"U" AND "H" GUIDING UNITS ALONE**

**15-DIGIT PRODUCT CODE**

**P 491 A - 1 - - - - A00**

**Product series**  
491 = Guiding units for cylinders

**Diameter (mm)**  
3 = 32    6 = 63  
4 = 40    8 = 80  
5 = 50    1 = 100  
6 = 63

**Standard stroke (mm)**  
Stroke to be indicated

**Accessory subtype**  
1 = Plain bearing «H» Guiding Unit  
2 = Ball bearing «H» Guiding Unit  
3 = Plain bearing «U» Guiding Unit

**Cylinder type**  
1 = Metric cylinders

**DIMENSIONS (mm), WEIGHT (kg)**



**"U" GUIDING UNIT**  
ISO 15552  
With slide bearings

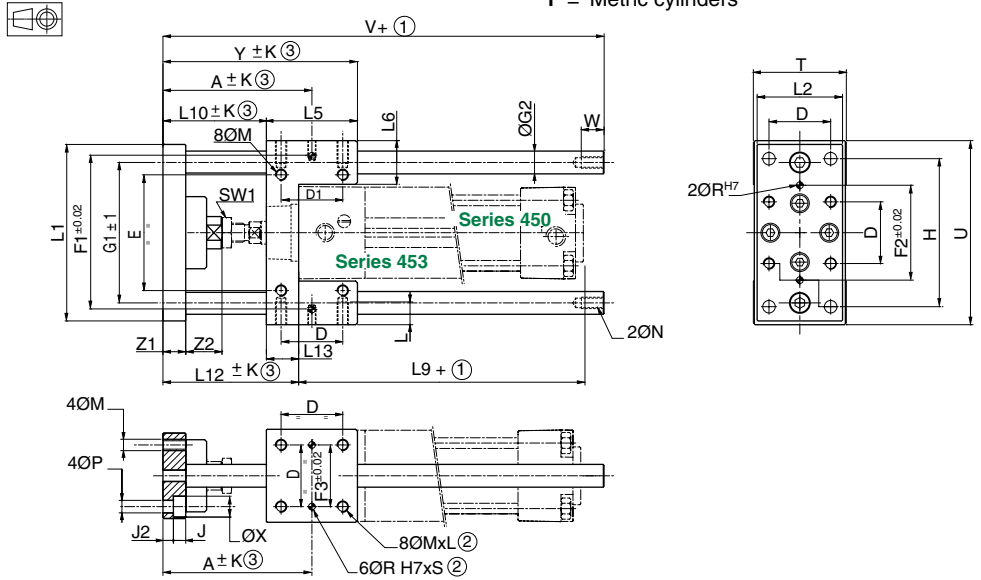

**"H" GUIDING UNIT**  
ISO 15552  
With slide or ball bearings

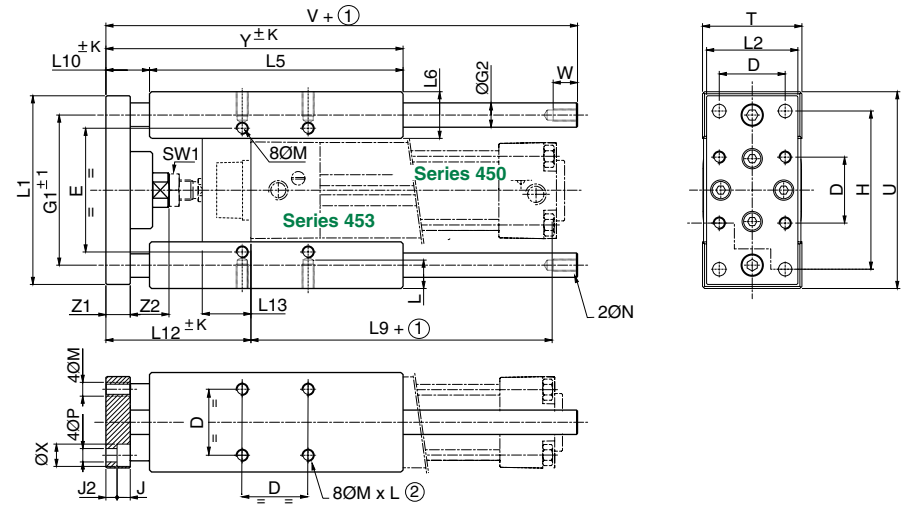

- ① Stroke
  - ② Depth
  - ③ Dimension variable: ± K    End play: 0,1 mm
  - ⊙ : 6 + 2 holes for centering pins (ØRH7)
- NOTE:** The guiding units with a linear ball bearings must be lubricated every 3000 km, and more frequently if they are used in dusty surroundings.

Ø (mm)	A	D	D1	E	F1	F2	F3	G1	G2	H	J	J2	K	L	L1	L2	L5		L6		L9	L10		L12
																	"U"	"H"	"U"	"H"		"U"	"H"	
32	78,5	32,5	32,5	61	81	50	32,5	74	12	78	6,5	5,5	2,5	12	93	45	48	125	23	23	98	54,5	21,5	71,5
40	85	38	38	69	99	54	38	87	16	84	6,5	5,5	3	12	112	55	58	140	28,4	28	109	56	17	77
50	97	46,5	46,5	85	119	72	46,5	104	20	100	8,5	6,5	4	16	134	65	59	148	33,4	33	110	67,5	22,5	92,5
63	106	56,5	56,5	100	132	82	56,5	119	20	105	9	6	4	16	147	80	76	178	33,4	33	125	68	21	93
80	130	72	50	130	166	106	72	148	25	130	11	9	5	20	180	100	90	195	41,8	41	132	81	31	115
100	140,5	89	70	150	190	131	89	173	25	150	11	9	5	20	206	120	110	218	41,3	42	142	81,5	30,5	120,5

Ø	L13		M	N	P	R (H7)	S	SW1	T	U	V	W	X	Y		Z1	Z2	weight			
	"U"	"H"												"U"	"H"			(6)		(7)	
32	17	24	M6	M6	6,6	6	10	16	49	97	182	11	11	102,5	146,5	12	25	0,750	1,3	0,00178	0,0018
40	21	28	M6	M6	6,6	6	10	18	58	115	192	11	11	114	157	12	25	1,230	2,4	0,00316	0,0032
50	25	34	M8	M8	9	6	10	24	70	137	237	16	15	126,5	170,5	15	29	2,150	3,5	0,005	0,005
63	25	34	M8	M8	9	6	10	24	85	152	237	16	15	144	199	15	29	2,890	4,8	0,005	0,005
80	34	50	M10	M10	11	6	10	30	105	189	280	16	18	171	226	20	27	5,700	8,4	0,0077	0,0077
100	39	55	M10	M10	11	6	10	30	130	213	280	16	18	191,5	248,5	20	27	7,950	11,8	0,0077	0,0077

(6) Weight of guiding unit for 0 mm stroke. Weight of the cylinders: see page P229  
(7) Weight to be added per additional mm stroke length.



**MAXIMUM ADMISSIBLE LOAD "F" ON THE ROD END**



**"U" GUIDING UNIT**  
With slide bearings



**"H" GUIDING UNIT**  
With slide bearings

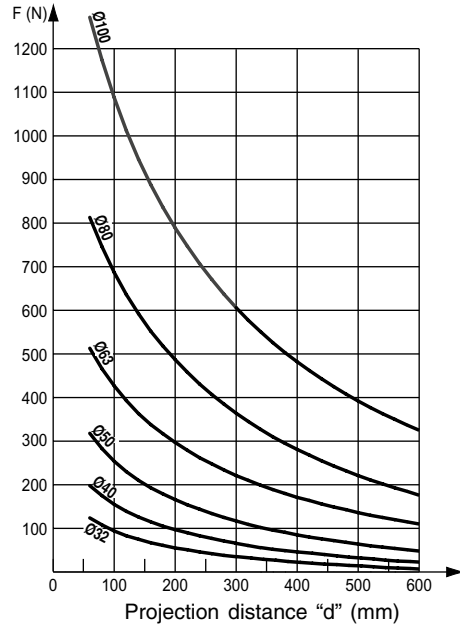
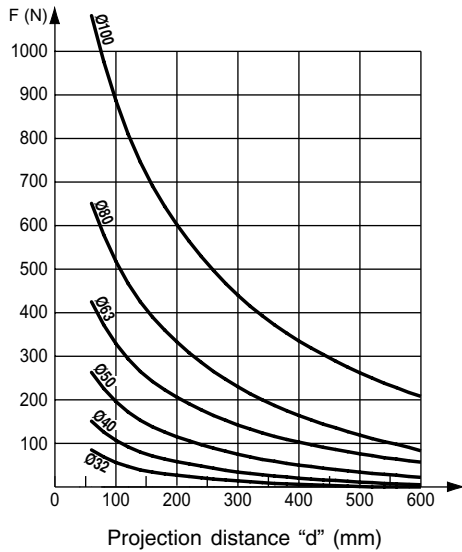

d = The projection distance (in mm) corresponding to the dimension L10 + the stroke length + the distance from the load centre of gravity (G) to the mating surface of the cylinder flange

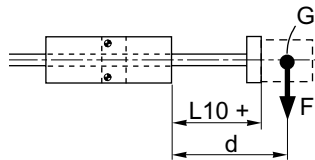

**Note:**

The values in the opposite chart correspond to those in regular horizontal movement of the guiding unit with the rods in the same horizontal plane. In the case of vibration or jerky movement, halve the maximum allowable load values.

**DETERMINING THE DEFLEXION :  $f_t$**

$$f_t = f_0 + \left( f_{10} \times \frac{F}{10} \right)$$

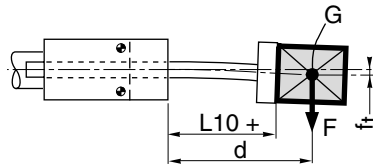

- $f_t$  = Total deflexion (mm)
- $f_0$  = Deflexion without a load (mm)
- $f_{10}$  = Deflexion with a load of 10 N (mm)
- F = Load on the rod ends (N)
- d = Projection distance as defined above (mm)

**Deflexion without a load ( $f_0$ )**

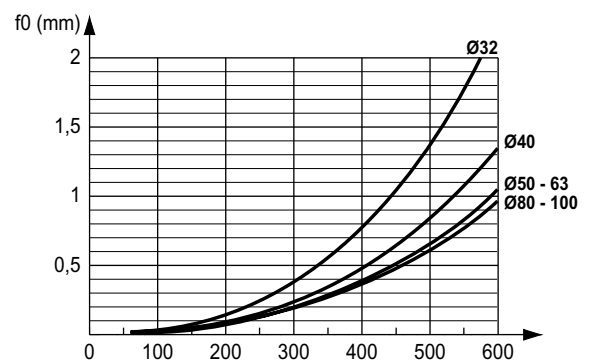
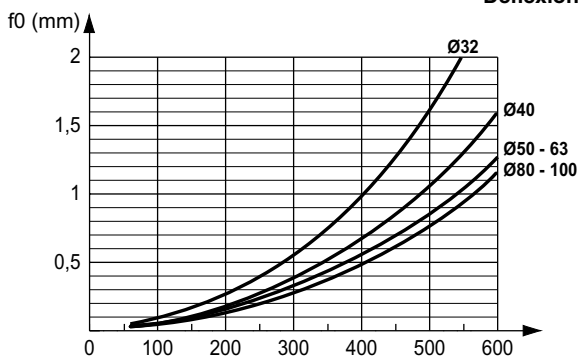

**Deflexion with a load of 10 N ( $f_{10}$ )**

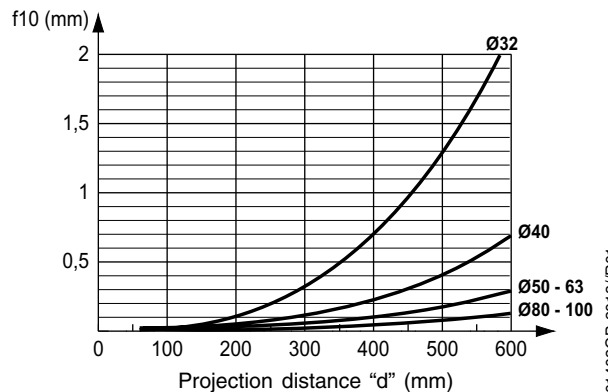
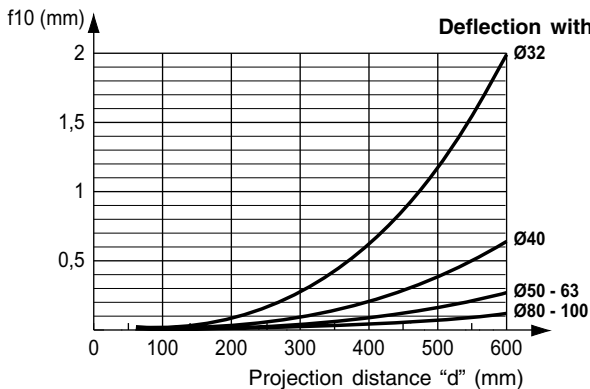

01402GE-2013/R01  
Availability, design and specifications are subject to change without notice. All rights reserved.



**"H" GUIDING UNIT**  
With ball bearings

**MAXIMUM ADMISSIBLE LOAD "F" ON THE ROD END**

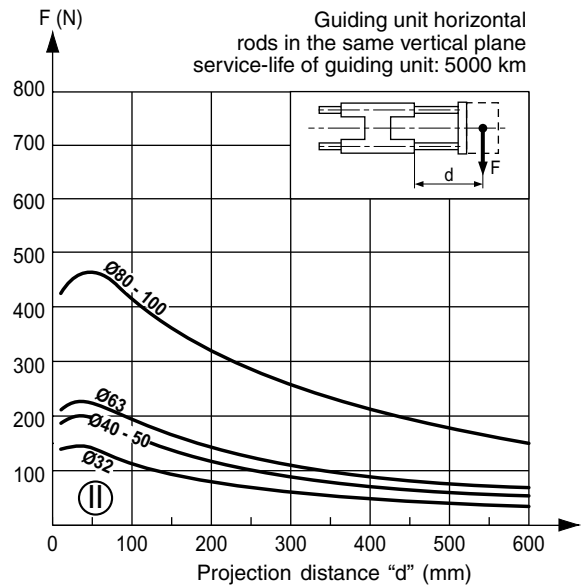
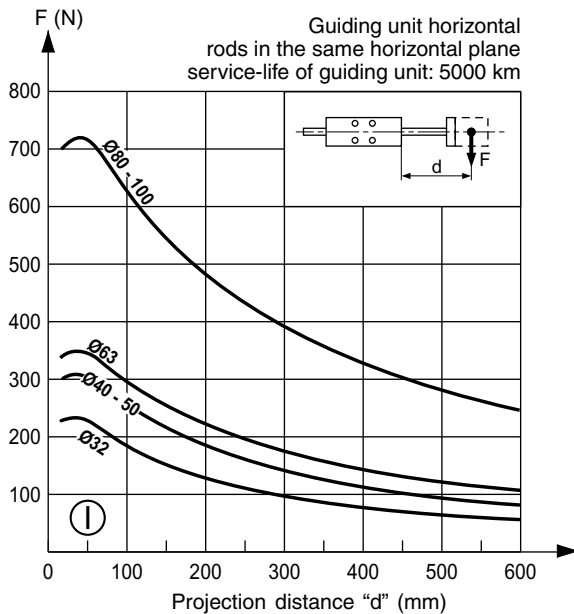

**MAXIMUM ALLOWABLE MOMENTS "Ms" AT ROD END**

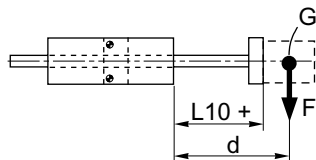
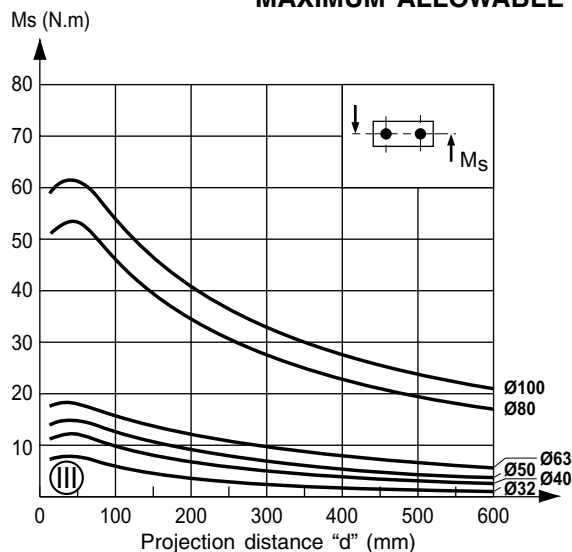

d = The projection distance (in mm) corresponding to the dimension L10 + the stroke length + the distance from the load centre of gravity (G) to the mating surface of the cylinder flange

**Note:** The values in charts (I), (II) and (III) correspond to those in regular horizontal movement. In the event of vibration or jerky movement, halve the maximum allowable values.

Whatever the stroke of the cylinder, if its movement is only a small proportion of the travel (not more than 60 mm) : it is necessary to reduce the maximum allowable torques and loads by multiplying the values taken from charts (I), (II) and (III) by coefficient K from chart (IV). For short travels which do not exceed 60 mm, the curves allow for this reduction in performance.

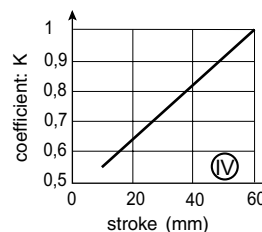

**DETERMINING THE DEFLEXION:  $f_t$**  (See "H guiding unit with slide bearings" preceding page)

**B**