



High accuracy digital timer features dual line LCD and multiple ranges... Every popular operating mode in a compact 1/16 DIN package

File No.: E96337

 RECOGNIZED RECOGNIZED

5
ELECTRONICS



An excellent value in its class, the B856 features a compact 1/16 DIN package, precise digital setting, versatile functionality, and a straightforward button-per-digit interface.

It can be easily programmed to perform any standard timing operation: On-Delay, Off-Delay, Interval, or Repeat Cycle. A unique On-Delay/Interval Mode can, in many cases, perform the function of two separate timers. Output is via DPDT relay contacts.

Five selectable time ranges and a programmable decimal point provide preset times ranging from 0.01 seconds to 9999 hours.

A standard model features a timed DPDT contact output while another model includes separate timed and instantaneous SPDT contacts. All are rated for 5 Amp loads.

Simplicity of operation is maintained while still providing a high level of functionality. All programming is done through the front panel, with an intuitive button-per-digit keypad that makes entry of preset times quick and easy. A crisp dual line LCD display lets the operator readily view elapsed or remaining cycle time as well as the preset value. Prominent annunciators indicate information such as the time range and the status of the input and outputs.

- Button-per-digit preset entry simplifies setup and operation
- High Contrast dual line LCD display indicates both Process Time and Preset Value
- Field selectable for operation in On-Delay, Off-Delay, Interval 1, Interval 2, or Repeat Cycle modes
- Universal Power Supply accepts 24 - 240 VAC or 24 VDC
- Designed to meet IEC 801 level 4 noise immunity standards for increased reliability
- Unique On-Delay/Interval mode lets one unit do the work of two in many applications
- Industry standard socket connection
- Programmable security levels prevent unauthorized setpoint or program changes
- UL, CUL recognized, CE compliant
- IEC IP65 rated front panel for use in washdown environments

Reliability is a key feature of the B856. IEC level 4 noise immunity ensures flawless operation in harsh electrical environments. Its IEC IP65 enclosure rating allows use in washdown conditions.

Wiring via an industry standard 11 or 8 pin socket and a power supply that can accept 24 - 240 VAC or 24 VDC vastly simplifies setup.

SPECIFICATIONS

Inputs:

Start : NPN or Dry Contact

Reset : NPN or Dry Contact

Outputs:

Timed (B856-500): DPDT - 5 amp

Timed (B856-501 & -511): SPDT - 5 amp

Instantaneous (B856-511): SPDT - 5 amp

Activation Time: 15 msec. max.

Physical:

Dimensions: 48mm x 48mm, 81mm deep

Mounting: Panel Mounting in 45 x 45 cutout or DIN rail

Wiring Connection: Via 8 pin (B856-501) or 11 pin (B856-500 & -511) plug-in socket

Operation:

Supply Voltage: 24 - 240 VAC 50/60Hz or 24 VDC

Power Consumption: 50 VA @ 240 VAC

Time Ranges: Field Selectable for Hours, Minutes, Seconds, Hours:Minutes, Minutes:Seconds

Resolution: Field selectable from XXXX to XX.XX for Hours, Minutes and Seconds

Operating Modes: On-Delay, Off-Delay, Interval 1, Interval 2, Repeat, On-Delay/Interval

Repeat Accuracy: ± 0.03%

Electrical Service Life: 100,000 cycles at full load

Mechanical Service Life: 10 million cycles at min. load

Environmental:

Front Panel Rating: IEC IP65

Operating Temperature: 0° to 60° C (B856-500);

0° to 55° C (B856-501); 0° to 50° C (B856-511)

Storage Temperature: -40° to 90° C

Humidity: 5% to 95% RH non-condensing

Weight: 100 grams (3.5 ounces)

Approvals:

B856-500 & -501: UL and CUL recognized, CE marked

B856-511: UL and CUL recognized

OPERATING MODES

On-Delay

Timing begins on the leading edge of the start input. The output will activate at the completion of the preset time (T) and will remain active until the reset signal is applied or power is interrupted.* For B856-511, the instantaneous output will activate upon the start signal and will remain active until the reset signal is applied or power is interrupted.*

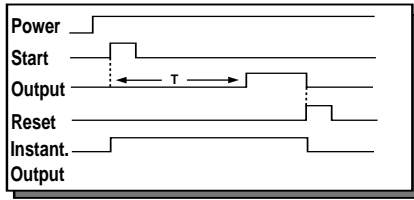

Off-Delay

The output is activated at the leading edge of the start signal. Timing begins on the trailing edge. The output will remain active until the preset time (T) has elapsed or power is interrupted.* Reapplying the start signal before T has elapsed will reset the time value. The reset input is not used.

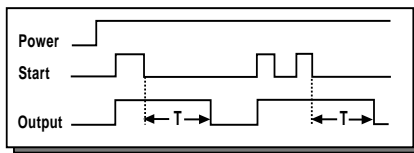

Interval 1

On the leading of the start input, the output is activated and timing begins. The output will remain active until the preset time (T) has elapsed or power is interrupted.* Removal of the start signal will also cause the output to be deactivated and the time value reset. The reset input is not used.

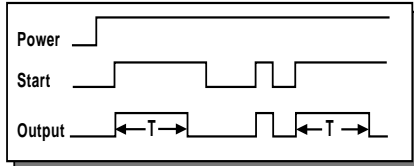

Interval 2

On the leading of the start input, the output is activated and timing begins. The output will remain active until the preset time (T) has elapsed or power is interrupted.* The reset input is not used. Reapplying the start signal has no effect unless the cycle has completed.

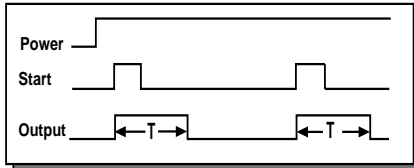

Repeat Cycle

Timing begins on the leading edge of the start input. A cycle is initiated where the output will be OFF for the preset time (T), then ON for the preset time. This cycle will continue until a reset signal is applied or power is interrupted.* The unit can also be programmed for the timing sequence to begin with an ON cycle.

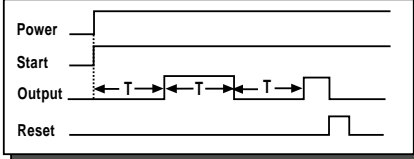

Delay/Interval

The delay cycle begins upon application of the start signal. The output will activate at the completion of the preset time (T1). Upon activation of the output, the Interval cycle will begin. The output will be deactivated at the end of the Interval time (T2). T1 is the primary preset value. T2 is settable from 0.1 to 999.9 seconds. The timing sequence and output can also be reset through the reset input or interruption of power.*

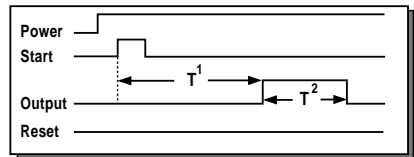

* The Power Reset parameter can be set so that a timing sequence will not be reset upon power interruption but instead continue on when power is restored.

Connections

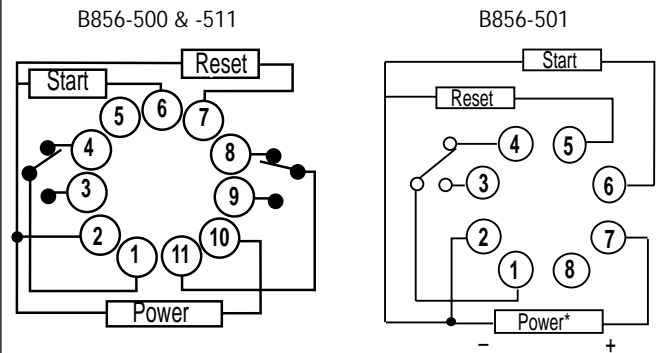

For the -511 version, Pins 1, 3, 4 are the instantaneous contacts

* 24-240 VAC or 24 VDC

Dimensions:

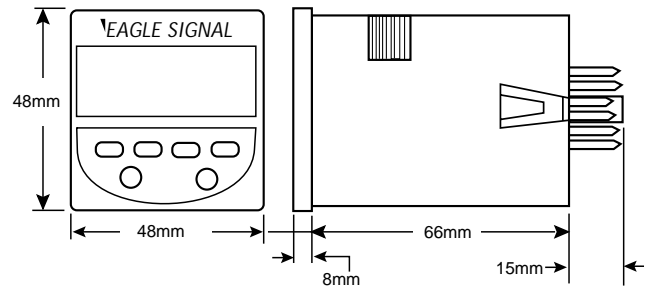

ORDERING INFORMATION

Description	Model
Multi-Function (11 Pin) Timer	B856-500
As Above w/Instant Contacts	B856-511
Multi-Function (8 Pin) Timer	B856-501*
*For Drop-In Replacement of LX260 DC Version, Order B856-502	

Accessories

B856-500 & -511:	
11 Pin Socket	60SR3P06
11 Pin Socket - Outward Facing Terminals	PBT-03172
B856-501:	
8 Pin Socket	60SR2P06
8 Pin Socket - Outward Facing Terminals	PBT-03155